

**BEST GIFTS** Systems, Games, CDs, and More

J A N U A R Y 1 9 9 8

Now incorporating  
**MacUser**

# Macworld

THE ESSENTIAL MACINTOSH® RESOURCE  
[www.macworld.com](http://www.macworld.com)

# Apple Delivers

TOP SPEED,  
LOW PRICE  
CHANGE THE RULES

- \$2,000 Desktop Demon
- PowerBook Beats Pentium



Think fast.

PowerPC

Power Macintosh G3











**Executions always look better from inside the hood.**

Introducing the La Cie Electron21™, the monitor with the color-enhancing Blue Hood.

Circle 52 on reader service card

**LACIE**



# Macworld



## Holiday Gift Guide

**78**  
**Read our list. Check it twice. It's got gifts in every price. Games, CDs, systems, and more.**

**80**  
**Great Games**  
 BY STEVEN LEVY AND CAMERON CROTTY Get out your joysticks: it's the 1998 Game Hall of Fame.

**87**  
**Stellar CDs**  
 BY WENDY SHARP Pick a gift from *Macworld's* favorite CDs.

**93**  
**Bargain Systems**  
 BY ALLYSON BATES Get a great deal on a new Macintosh for less than \$2,000.

**98**  
**Irresistible Extras**  
 Treat your friends (or yourself!) to these fun finds.

## Features

- 68** **Apple's Next-Generation Systems**  
 BY ALLYSON BATES The PowerPC 750 debuts at an amazing price, bringing top power to everyone.
- 74** **Fastest Laptop Yet**  
 BY HENRY BORTMAN The newest PowerBook retakes the lead over PC notebooks.

## News

- 22** **Apple Ships Rhapsody**  
 Developers get their first look at Apple's new operating system, but the Mac OS still rules.
- 24** **Coming Soon to a Service Bureau Near You**  
 Digital presses offer better personalization; large-format ink-jet printers make great strides.
- 26** **Macromedia Unplugged**  
 The Universal Media Initiative lets you view Shockwave and Flash animations without special plug-ins.
- 28** **Bryce 3D**  
 MetaCreations adds animation to the 3-D-landscape generator.

## MacUser

- 117** **10 Typographical Blunders**  
 BY KATHLEEN TINKEL Don't be type negative.
- 122** **Mixing Color and Gray Scale**  
 BY SHERRY LONDON Show more restraint than Ted Turner.
- 125** **Walking the Browser Tightrope**  
 BY JASON SNELL Be the Switzerland of Web publishing.
- 126** **Have Mac, Will Do Windows**  
 BY SCOTT BURY Adapt without being assimilated.
- 128** **Help Folder**  
 BY BOB LEVITUS AND CHRISTOPHER BREEN Bob and Chris answer all your questions.
- 132** **The Forbidden Mac**  
 BY CHRISTOPHER BREEN Sex, drugs, and Windows 95.
- 134** **Transitions**  
 BY ANDY IHNATKO He's quite aware of what he's going through: ch-ch-ch-changes.



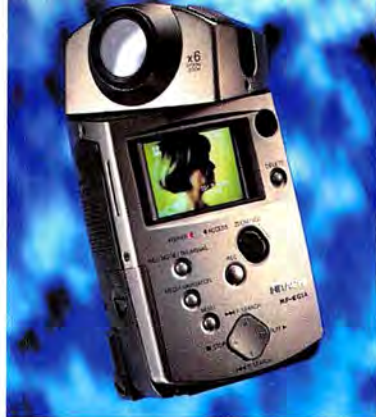

Capture the moments, with the MP-EG1A, in Reviews, page 46.



Large-format ink-jet printers, in News, page 25.

# Reviews

- 38 ★★★/6.9 Quicken Deluxe 98  
Personal-finance software
- 40 ★★★★★/7.1 Maxpower Pro 250/125;  
★★★★/7.2 Maxpower Pro+ 266/177  
PowerPC 750 upgrade cards
- 41 ★★★★★/8.3 ClarisWorks Office  
Productivity suite
- 42 ★★★/5.6 Act 2.8;  
★★/4.0 Lotus Organizer 97 GS  
Personal information managers
- 43 ★★/4.1 DeltaVideo 1.1;  
★★★★/8.2 DigitalRadar  
Motion-detection software
- 44 ★★★/5.7 Commotion 1.0.5;  
★★/4.5 Illuminaire Paint 1.1  
Video-painting software compared
- 46 ★★★/6.4 MP-EG1A  
Digital-video camera
- 48 ★★★/5.9 Cubasis AV  
Audio and MIDI package
- 50 ★★/4.8 Family Tree Maker Deluxe  
Edition II 3.02;  
★★★★/8.7 Reunion 5.02  
★★/3.0 Ultimate Family Tree Deluxe  
Genealogy programs compared
- 52 ★★★/6.5 FirstClass Intranet Server  
Messaging system/intranet server
- 54 ★★★★★/8.4 Apple Network  
Administrator Toolkit 2.0  
Educator-oriented suite
- 56 ★★/4.5 PrimeraPro Elite  
Second look: Dye-sub/thermal-wax printer
- 56 ★★★★★/8.5 Timbuktu Pro 4.0  
Remote-access and -control package
- 58 ★★★/5.2 Private File 2.0  
Encryption utility
- 58 ★★★★★/7.2 Vibe Enterprise 1.0.1  
Java tools for business
- 60 ★★★/6.0 FlashBack  
File-recovery utility
- 60 ★★★★★/8.6 MathType 3.5  
Equation-generation utility
- 62 ★★/4.8 NetCenter Internet Station  
LAN Internet router
- 64 ★★★★★/8.2 Power3D  
3-D-acceleration card for games

## Opinion

- 13 Letters
- 17 The Vision Thing  
BY ANDREW GORE The  
Mac is a great game machine.
- 194 The Desktop Critic  
BY DAVID POGUE Steve  
Jobs in *It's a Wonderful Legacy*.
- 8 How to Contact Macworld

## Tribute

- 31 Remembering Cary Lu  
BY CATHY ABES *Macworld* says  
goodbye to a dear friend and an  
incredible colleague.

## Media

- Special Report
- 108 Publishing Workshop  
BY DAVID BLATNER AND GALEN  
GRUMAN QuarkXPress your-  
self with version 4.0.
- 114 Graphics Workshop  
BY CATHY ABES Simple sal-  
vaging techniques in Photoshop.

## Secrets

- 103 Calmly Coping with File  
Disasters  
BY JOSEPH SCHORR Mac  
Heimlich maneuvers.
- 105 Quick Tips  
BY LON POOLE Tips, tricks,  
and shortcuts.



Quicken personal-finance package gets richer, in Reviews, page 38.

**ON THE COVER**  
Product photograph  
by Paul Franz-Moore;  
photo manipulation  
by Bert Monroy



# Macworld

EDITOR IN CHIEF Andrew Gore  
EXECUTIVE ASSISTANT Patricia Carberry-Harris

## EDITORIAL

EDITOR Galen Gruman  
EXECUTIVE EDITOR Carol Person  
SENIOR EDITOR/NEWS Stephen Beale  
SENIOR EDITOR/FEATURES Elizabeth Dougherty  
SENIOR EDITOR/REVIEWS Anita Epler  
SENIOR EDITOR/DEPARTMENTS Nancy Peterson  
SENIOR TECHNOLOGY EDITOR Henry Bortman  
SENIOR ASSOCIATE EDITORS Cathy E. Abes, Linda Comer, Jason Snell, Katherine L. Ulrich  
ASSOCIATE EDITORS Allyson Bates, Keith Mitchell, Scholle Sawyer, Brooke C. Wheeler

## CONTRIBUTING EDITORS

David Biedny, Christopher Breen, Bruce Fraser, Ted Landau, Deke McClelland, David Pogue, Lon Poole, Joseph Schorr, Franklin N. Tessler

## LAB

LAB DIRECTOR Jeffrey S. Pittelkau  
ASSISTANT LAB DIRECTOR Susan Silvius  
SENIOR LAB ANALYSTS Jeffy K. Milstead, Kevin Mitchell  
ASSOCIATE LAB ANALYST Gil Loyola

## COPY EDIT

MANAGING EDITOR Claire H. Breen  
COPY CHIEF Paul-Michael King  
SENIOR TECHNICAL COPY EDITOR Rhoda Simmons  
SENIOR COPY EDITOR Jon Zobenica

## ART AND DESIGN

DESIGN DIRECTOR Eleanor Leishman  
ART DIRECTOR Sylvia Chevrier  
ASSOCIATE DESIGNERS Martha Katt, Michael Rattary  
LAYOUT ARTIST Jackie Goodman

This issue is dedicated to the memory of Cary Lu.

# AnthroCarts!®

Configure them the way you want!



See all these and *more* in our free catalog, then call us direct to order. We'll ship to you the very next business day!



**800-325-3841**  
6:00 AM to 6:00 PM PST, M-F

**ANTHRO**®

Anthro Corporation®  
Technology Furniture®  
Tualatin, OR 97062  
Fax: 800-325-0045  
Japan: 03 (Tokyo)-3947-2735  
[www.anthro.com](http://www.anthro.com)



Lifetime Warranty. Dozens of shapes and sizes, over 75 accessories.  
Since 1984. Prices from \$299. GSA contract. Available for OEM applications.



Created on a  
Macintosh with 64MB  
of Kingston memory.

Created on a  
Macintosh with 8MB  
of Kingston memory.

Created on a  
Macintosh with 128MB  
of Kingston memory.

THESE DAYS,  
IT TAKES A LOT MORE  
MEMORY  
TO BE YOUR  
BEST.



MANY OF THE MASTERPIECES created on a

Macintosh have one very powerful ingredient in common: Kingston memory. As software becomes more and more complex, memory demands go up. Of course, it's not only the amount of memory that matters, it's the quality. Nobody understands that better than Kingston. We test 100% of our modules. In fact, we test every cell on every chip on every module. On a 16 megabyte module, that's 128 million cells. Only the modules that survive get the Kingston name. That's why we're an Authorized Apple RAM Developer and committed to selling the highest quality Macintosh memory. After all, your best work is a showcase for our best work. To find Kingston memory that was made specifically for your Macintosh, just call (800) 259-8965.

[www.kingston.com/ad](http://www.kingston.com/ad)



**Kingston**  
TECHNOLOGY  
COMPUTING WITHOUT LIMITS™



Kingston Technology Company, 17600 Newhope Street, Fountain Valley, CA 92708, USA, (714) 435-2600, Fax (714) 435-2699 © 1997 Kingston Technology Company. All rights reserved. Computing Without Limits is a trademark of Kingston Technology Company. All other trademarks and registered trademarks are the property of their respective owners.

Circle 201 on reader service card



# ZIP!ZIP!ZIP!ZIP!ZIP



## VST Puts a Little Zip™ in your PowerBook



VST proudly introduces the Zip100 drive, a Zip drive designed for use in the PowerBook 3400, 190/5300 and 1400 Expansion Bay. VST Zip100 drives use the same disks as Iomega's desktop version, each storing up to 100MB of data. Zip disks are ideal for backing up important files, for archiving data, and for cleaning up crowded hard drives. Transferring large files and databases from your PowerBook to your desktop machine is now quick and easy using Zip disks.



Available At:



**Mac WAREHOUSE**  
1-800-255-6227

MacConnection  
800-998-0040

**ClubMac®**  
1-800-258-2622

**Mac Mall**  
1-800-222-2808



Visit Us At: [www.vsttech.com](http://www.vsttech.com)

Questions? Call Us At: (508) 263-9700

Iomega, the Iomega logo, Zip, and The Capacity To Do More are trademarks of Iomega Corporation. All other trademarks are property of their respective holders. Iomega patents protected by patent applications pending in the US and other countries.



Circle 73 on reader service card

# Macworld

PRESIDENT AND CEO Colin Crawford  
ASSISTANT TO THE CEO Sharon Sanderson  
CHIEF FINANCIAL OFFICER Stephen Daniels  
FINANCIAL ANALYST Eos de Feminis  
VICE PRESIDENT OF HUMAN RESOURCES Shelly Ginenthal  
EMPLOYEE RELATIONS MANAGER Marisa Chow

Macworld is a publication of Mac Publications, L.L.C.

## DISPLAY ADVERTISING SALES

PUBLISHER Matt Sweeney (415/978-3271)  
NATIONAL SALES DIRECTOR Steve Plevin (415/978-3138)  
SALES DEPARTMENT ADMINISTRATOR Nancy Galanty (415/978-3124)  
SALES/MARKETING COORDINATOR Glenn Munlawn (415/974-7350)  
WESTERN ADVERTISING DIRECTOR Karl Elken (415/978-3155)  
ACCOUNT EXECUTIVE Christine Wong (415/978-3192)  
NATIONAL ACCOUNTS MANAGER Liz Pabón (415/978-3192)  
ACCOUNT EXECUTIVE Jessica Ross (415/267-1799)  
NATIONAL ACCOUNTS MANAGER Sara Culley (310/545-0646)  
ACCOUNT EXECUTIVE Margaret Level Green (415/267-4577)  
EASTERN ADVERTISING DIRECTOR Cynthia Ramsey (201/243-1197)  
NATIONAL ACCOUNTS MANAGER Paul Bonarrigo (508/533-4020)  
NATIONAL ACCOUNTS MANAGER Lisa Laddle-Wallace (904/284-4972)  
ACCOUNT EXECUTIVE Jo Zotterelli (516/277-4134)

## RESEARCH

RESEARCH DIRECTOR Linda Lawrence  
SENIOR RESEARCH ANALYST Phillip Hibbert

## MARKETING

MARKETING MANAGER Kelvin Gee  
MARKETING MANAGER Renée Bula  
EVENTS MANAGER Anna Noetzel  
MARKETING COORDINATOR Stephanie Walter

## PRODUCTION

VICE PRESIDENT OF MANUFACTURING Anne Foley  
PRODUCTION MANAGER Cynthia Neustadt  
ASSISTANT PRODUCTION MANAGER David W. McAferty  
DTP COORDINATORS Clayton Haberman, Brian Mullin

## ONLINE

PUBLISHER Jeff Julian  
NATIONAL ACCOUNTS MANAGER Ed Ramirez  
ACCOUNTS MANAGER Nicholas Harvey  
MEDIA COORDINATOR Jamila Johnson  
EDITOR James S. Bradbury  
SHAREWARE EDITOR Philip W. Dyer  
ONLINE PRODUCTION EDITOR Roxanne Gentile  
CONTENT ENGINEER Caius van Nouhuys  
ASSISTANT CONTENT ENGINEER Jessica Graves



## what you do:

redraw, stress  
scroll, stress  
render, stress  
rasterize, stress  
model, stress  
filter, stress . . .

## what we do:

make all of the above  
happen faster than  
you've ever dreamed.  
(without the stress)



From the makers of TwinTurbo® come the powerful, perfectly balanced graphics board solutions you've been hoping for. With ix3D Ultimate Rez and ix3D Pro Rez, you eliminate those long, gut-wrenching moments spent waiting for your computer to execute the 2D, 3D and video functions on which your creativity depends. ix3D takes the stress out of understanding, selecting, affording and using the perfect graphics accelerator for your individual needs:



**ix3D Ultimate Rez** for graphics experts who need all the power they can get to drive today's largest monitors at extreme resolutions and color depths-while maintaining fast, ergonomic refresh rates. Ideal for 2D, 3D and CAD applications like Adobe Photoshop, QuarkXPress, Electric Image, LightWave 3D, Strata Studio Pro and Microstation.



**ix3D Pro Rez** optimizes the performance and value for users who need uncompromising graphics power and who routinely operate 17-19" monitors at moderate resolutions like 1152 x 870.



**ix3D Mac Rocket** is perfect for home and office users, providing a blast of pure 128-bit 2D graphics power to common operations like image scrolling or text draws, and outrageous 3D performance for lightning fast, realistic 3D gameplay.

All the ix3D boards are powered by IXMICRO's new 128-bit controller, the TwinTurbo 128-3D. Just look for ix3D at your favorite retailer, or check out our web site for more details. **And stop stressing.**

**ix3D**<sup>TM</sup>  
[www.ixmicro.com](http://www.ixmicro.com)





# PC Compatibility?

## Don't get a Virtual Lemon...



# Squeeze Orange<sup>®</sup>PC in Your Apple

Sometimes you must run a PC application on your Mac. The OrangePC<sup>®</sup> is an expansion card which allows you to run both Mac and PC programs simultaneously. It magically transforms your Apple into a dual computer platform which can support Windows<sup>®</sup>NT, Windows<sup>®</sup>95, Windows<sup>®</sup> 3.1 or DOS. It makes thousands of PC applications compatible with your Macintosh system.

If you have a PCI based Performa (7" expansion slot), a full-sized PCI Power Macintosh compatible (12" slot) or a NuBus based Quadra, there's an OrangePC solution that's right for you. Whether you are budget sensitive, or performance hungry, you may select a low end processor, or one as fast as our

exclusive Pentium<sup>®</sup> 233MHz with MMX<sup>™</sup> technology.

And, the OrangePC is affordable, with prices starting at \$499.



*The technical stuff: OrangePC models come in 7" or 12" PCI, and NuBus card types; up to Pentium 233MHz MMX; RAM from 8 to 256MB on board; up to 256K pipeline burst L2 cache; parallel port (for those delightful PC dongles); 2 high speed serial ports; 16 bit Sound Blaster<sup>®</sup> compatible In/Out; game port; one or two MB of video DRAM.*

Call us today, and squeeze an OrangePC in your Apple.



"17 Years of Innovation and Excellence"  
1400 N. Lakeview Ave., Anaheim, CA 92807  
(714) 779-2772 www.orangemicro.com

© Orange Micro, Inc., 1997

Circle 33 on reader service card

# Macworld

## HOW TO CONTACT MACWORLD

### Subscription Questions

Phone	303/665-8930
Fax	303/604-7455
U.S. Mail	Subscription Services P.O. Box 54529, Boulder, CO 80322
America Online	Keyword Macworld
World Wide Web	<a href="http://subscribe.macworld.com/service/">http://subscribe.macworld.com/service/</a>

### Reprints and Permissions

You must have permission before reproducing any material from Macworld. Write to Macworld, Reprints and Permissions, 501 Second St., San Francisco, CA 94107; include a phone number. To order reprints of your company's editorial coverage, call 800/217-7874.

### Back Issues of Macworld

Back issues are \$7 per issue for U.S. delivery (\$12 overseas); prepayment in U.S. funds is required. Make checks or money orders payable to Macworld Magazine and mail along with a written request to Macworld Back Issues, c/o Synder Newell, P.O. Box 7046, San Francisco, CA 94120-9727. Readers can obtain newsstand premiums by mailing a check for \$2.95 (for shipping and handling) to Macworld, Newsstand Promotions, 501 Second St., San Francisco, CA 94107; please state CD title and issue, and include your name and address for shipping.

### Macworld in Microfilm

Macworld is available on microfilm and microfiche from UMI, 300 N. Zeeb Rd., Ann Arbor, MI 48106-1346; 313/761-4700.

### Macworld Editorial

The editors of Macworld welcome your tips, compliments, or complaints. We are unfortunately unable to look up stories from past issues, recommend products, or diagnose your Macintosh problems by phone, e-mail, or fax. Contact Apple toll-free at 800/538-9696, ext. 500, for information on user groups in your area.

Our offices are located at 501 Second St., San Francisco, CA 94107; 415/243-0505, fax 415/442-0766.

**LETTERS TO THE EDITOR** Direct all comments and suggestions regarding any aspect of the magazine to [letters@macworld.com](mailto:letters@macworld.com). Due to the high volume of mail received, we can't respond personally to each letter. We reserve the right to edit all submissions. All letters published in Macworld or Macworld Online become the property of Macworld.

**QUICK TIPS** Send your questions or tips on how to use Mac computers, peripherals, or software to the attention of Macworld, Quick Tips, 501 Second St., San Francisco, CA 94107; fax 415/442-0766; e-mail [quicktips@macworld.com](mailto:quicktips@macworld.com). Please include your name, address, and telephone number.

Macworld is a publication of Mac Publications, L.L.C. Macworld is an independent journal not affiliated with Apple Computer, Inc. Macworld, MacUser, MacWeek, Macworld Interactive, Macworld Shopper, MW, MW Lab, MW Shopper, The Desktop Critic, Expert Graphics, Quick Tips, Star Ratings, Buyers' Tools, Streetwise Shopper, and Conspicuous Consumer are registered trademarks of Mac Publications, L.L.C. Apple, the Apple logo, Mac, and Macintosh are registered trademarks, and MacLetter and PowerBook are trademarks, of Apple Computer, Inc. Printed in the United States of America. Copyright © 1998 Mac Publications, L.L.C. All rights reserved.





# Out of Your Mind!

## Introducing Nexus GA from ATI

From your brain to the big screen and the printed page faster than you can change your mind - ATI's Nexus GA will dramatically improve the graphics capabilities of your Macintosh computer. Specifically designed for graphics professionals and content creators, ATI Nexus GA offers high-performance 2D and 3D graphics in one affordable, easy-to-install board.

Nexus GA offers no-compromise 2D graphic performance with true color in all the modes you demand up to

1920x1080. Work better and faster in all your favorite applications like PhotoShop, and Infini-D, with 8MB of WRAM memory upgradeable to 16MB.

### 2D Performance - MacBench 4.0

ATI NEXUS GA	316
IXMicro TwinTurbo 128M8	297
Matrox Millennium	254

Larger Numbers are Better

Plus, with Nexus GA's 3D functionality and QuickDraw 3D™ support you can add 3D elements to any of your design and multimedia projects. Nexus GA will take your content creation to new heights with a full suite of 3D tools and workstation-class performance.

And because Nexus GA is from ATI, makers of award-winning graphics accelerators for Macintosh computers, you can rest easy that Nexus GA will work seamlessly with your applications. Nexus GA - fastest, high resolution true color performance - to choose anything else you'd have to be out of your mind.

© Copyright ATI Technologies Inc. 1997. ATI, 3D RAGE PRO, and NEXUS are trademarks, or registered trademarks of ATI Technologies Inc. All other company and/or product names are trademarks and/or registered trademarks of their respective manufacturers. \*MacBench 4.0 Hi Res Publishing Mixes Tested on a PowerMac 9600/200 32MB. All Boards had 8MB. Test Mode: 1280x1024x75 Hz @32bpp. Tested using Driver Versions: ATI RAGE PRO 3.0 / IXMicro TwinTurbo 4.0.2 / Matrox Millennium 2.10. Features and specifications are subject to change without notice.



MICRO CENTER

MAC WAREHOUSE

1-800-275-4221

Circle 256 on reader service card

Now You See It.™  
www.atitech.com/macwo









**Dream Machine.**

**Not The Bike.**

**The Digital Color Copier.**

## **Aficio Color™ 2003**

Digital Color + Productive B & W  
Unique optional embedded Fiery  
Network printer-scanner option  
Prints up to 11 x 17 format



**\$14,895. A Digital Color Copier For  
Every Department, Every Company.**

Brilliant color every office can afford.

Spectacular presentations instantly.

Experience the productivity of easy,  
digital features for thousands less.

Get a demo of the kind of colorful  
future your office can enjoy, from  
the #1 maker of digital copiers  
in the USA. Call 800 63 RICOH.

Online [www.ricoh-usa.com](http://www.ricoh-usa.com)



**RICOH®**

Image Communication

Circle 4 on reader service card





# Don't Be Fooled By Imitations!

**Insist on XANTÉ Products With Genuine Adobe® PostScript® 3™!**

Don't settle for an imitation. Get the real thing!

XANTÉ® customers demand the best. That is why XANTÉ guarantees true Adobe PostScript on all of our products. And we don't stop there.

With XANTÉ's line of high resolution laser printers, computer-to-film, and computer-to-plate devices, you'll receive the most technologically advanced features available on the market today:

- Up To 1200 x 1200 DPI Resolution
- Oversized 11" x 17" Printing Up To 12" x 25"
- Negative Enhanced Imaging Technology (NEIT) For Quality Negative Film
- Accurate Calibration Technology (X-ACT™) For Precise Dimensional Accuracy
- Densitometer Support
- Halftone Calibration Technology and much more!

*Accept No Substitute! - Call XANTÉ today...*

**800-926-8839** Ext. 2144

Dealers Call Ext. 2145

[www.xante.com](http://www.xante.com)



Adobe® PostScript® 3™

**XANTÉ**  
Innovations in Printing Technology

**Up To \$1500 REBATE!**  
When you send in your "imitation" PostScript printer.  
Hurry! Offer expires 12/31/97

© 1997 XANTÉ CORPORATION. XANTÉ, Accel-a-Writer, and X-ACT are trademarks or registered trademarks of XANTÉ CORPORATION. Adobe, PostScript, PostScript 3, and the PostScript logo are trademarks of Adobe Systems Incorporated. Other brands and product names are trademarks or registered trademarks of their respective holders. XANTÉ CORPORATION, 4621 Spring Hill Ave., Mobile, AL 36608, P.O. Box 16526, Mobile, AL 36616-0526, Phone: (334) 342-4840, Fax: (334) 342-3345.



# Letters

## Apple-soft?

CONGRATULATIONS, *MACWORLD*, for realistically reporting on the alliance that former rivals Microsoft and Apple have recently formed ("Apple Forges Alliance with Microsoft," *News*, October 1997). Your coverage should be compared with the ridiculous media babble usually associated with Apple. Thank you for focusing on Apple's recent accomplishments, steadfast visions, and ambitious hopes for the future. With or without outside assistance, Apple Computer will continue its culture of innovation and determination, constantly creating new standards for others to follow.

DYLAN RHEA  
Dallas, Texas

THIS WHOLE APPLE-MICROSOFT deal brings to mind scenes from the Frank Capra movie *It's a Wonderful Life*. I'm not going as far as to say that the whole town will show up to save the day, or that Steve Jobs and Bill Gates can't really work together to make the world a better place. I just hope that this alliance does not reduce Apple to a puppet government and that the geniuses behind the Macintosh don't simply become another bunch of left-brained, memo-writing, number-crunching calculators.

JASON D. PALMER  
Darien, Georgia

## Communicator Is Overrated

PAUL DEVINE IS ONLY HALF RIGHT when he praises Netscape Communicator 4.01's small RAM appetite compared with Navigator 3.01's (*Reviews*, October 1997). Communicator requires 3MB less RAM than its predecessor



from the Format menu, select Use Custom Colors, and click on Background.—Paul Devine

## Keep 'Em Separated

I SEE APPLE AS THE MAKER OF A great operating system and well-built (but not cutting-edge) computers. Often surpassed by the clone makers, Apple now uses the leverage of its OS availability to protect its hardware sales. I think Apple should divide its hardware and software operations into two separate holdings. Current stockholders could be given a choice of how they wish to have their holdings redefined. The wisdom of this is that neither the hardware nor the software operation would be forced to support the other, encouraging each to maximize profitability. The only problem is that most Apple stockholders would probably opt for the Mac OS and software and dump the hardware. But what if the hardware division started looking at another OS? Now that's a performance incentive for each side!

RORY IVERS  
La Jolla, California

## The Mac Lurches Forward

IRONICALLY, GIVEN ITS PUTATIVE technical prowess, the United States has a long history of standardizing on mediocre technology (QWERTY keyboards, VHS, 525-line television, and so on). Therefore, I am not surprised that the Macintosh has largely lost the desktop battle with Windows. The blame for much of this must be placed with Apple, which has been arrogantly assuming that superior technology will inevitably tri-

only when virtual memory is enabled. With your Mac at full speed and virtual memory off, it requires a scant 1MB less than Navigator 3.0—and that's without Conference and the other Communicator add-ons.

As for 4.01's stability, my system froze up the first time I used Communicator. Add a goofy, cartoonish new interface that looks like Microsoft Internet Explorer meets Hanna-Barbera; the inability to set background color in mail windows (this works only in the browser for some reason); and the absence of 3.01 button features such as Reply To All, and I'd say Communicator 4.01 isn't worth the bandwidth its hype is uploaded on.

MATTHEW RUBEN  
Philadelphia, Pennsylvania

*You'll save memory without a performance hit if you turn on virtual memory and set it to provide only 1MB of memory more than your physical RAM. To set the background color of e-mail messages, choose Colors and Background Image*



## CORRECTIONS

- *Deneba Software's Canvas 5.0.2 received a Star Rating of ★★ ★/5.9 (Table of Contents, November 1997).*
- *Scott Hazen Mueller's name was spelled incorrectly in "Stopping Junk E-Mail," News, November 1997.*
- *RDG Tools' DittberBox 1.0 is able to "paint" with hybrid colors and received a Star Rating of ★★ ★ ★/8.9 (Reviews, November 1997).*

umph over the savvy marketing of the mediocre. In fact, the opposite has usually been the case.

The additional irony is that, as its market share drops, the Mac platform is evolving at an astonishing pace. I'm writing this with a two-month-old PowerBook 3400/200c, which is the finest computer of any kind that I have owned. I bought my wife a PowerCenter Pro last month, and it as well is fast, stable, and a joy to use. Forget the media circus, the Mac OS has never been as good as it is now. If you wish to get a lot of work done efficiently and with minimal headache—indeed, with elegance—consider this gem of a computing system.

LARRY CROCKETT  
*Eagan, Minnesota*

## Just Be

I THINK *MACWORLD* SHOULD DRAMATICALLY expand its coverage of the BeOS for Power Macintosh. I'm using Be to compose this letter, as well as to Web surf and Tëlnet to my campus e-mail system. The Internet functionality in Be is beautiful, seamless, and best of all, as fast as warp speed. It makes Mac OS 8 seem pokey and unresponsive in comparison. The BeOS is what the Mac OS and Windows both dream about being. I hope Apple won't regret not licensing Be when it had the chance. I think the BeOS is a very viable alternative to Apple's OS for those of us who are committed to the PowerPC chip. I hope that with the release of BeOS 1.0 there will be a version of Microsoft Office to go with it. That will be all I need to abandon the Mac OS and use Be for everything.

MARK KAIMAN  
*Syracuse, New York*

## Apple Turns Back the Clock

IN THE MACINTOSH WORLD, WE'VE all been acting superior over the ability of *our* computers to properly handle dates after the turn of the millennium. In fact, Apple has simply pushed the problem 20 years into the future. Inputting a year in the near twenty-first century with just two digits (for example, 05) returns the correct four-digit year (2005). But try the same technique with a year after 2019, and you'll find your Mac suddenly warping itself back to the Age of the Flappers.

JOHN DICKISON  
*Tokyo, Japan*

## To License or Not to License . . .

NO ONE IS MORE EXCITED OVER the presence of Steve Jobs than I, but for different reasons. Since the licensing of clones, the share of the Mac OS in the computer world has stayed the same, while Apple's share of the market has fallen proportionally to the clone makers' gains. Now Jobs is trying to slow this decline by making it tougher and more costly to license the Mac OS. If the clone makers threaten to go PC or to Be, let them. If they want the best, they should pay up. The Macintosh is the Mercedes-Benz of computers. Sure, 94 percent of the American public drives Chevys and Fords, but do they really compare to the German models?

BOB MARKETOS  
*Petaluma, California*

## Smile, Uncle Bob!

*MACWORLD'S* REVIEWS OF SCANNERS, color printers, and digital cameras are seriously flawed by the type of image used for evaluation. Take the "Midrange Digital Cameras" review in the October 1997 issue. The glacier picture provides no information about the image quality of more-mundane stuff—like Mom, Dad, and the kids. Your readers want to know how these devices render skin tones. How about taking pictures of people when testing digital cameras? I think we'd all learn a lot more if these subjects were used.

JEFF ZIEGLER  
*Salem, Missouri*

## Don't Hack the Hackers

I LOVED THE ARTICLE BY DAVID Pogue about "warez" and AOL (*The Desktop Critic*, October 1997). I'm 13, and I use AOL. I've been a small and insignificant member of the warez community. I've seen the meeting places and talked to people who are high up in the community. I'm not fanatic about it. I can't give you every commercial program ever made, nor can I tell you where to get them all.

I agree with many of the points made in Mr. Pogue's article, but I have one disagreement. You called the warez people "hackers." I don't think they are. The definition of *backer* is a very disputed thing. Hackers were originally smart Unix programmers, people who could program, or "hack," their way out of a tight situation. Then the term morphed and began to mean "computer intruder." *Hacker* does *not* mean "software pirate." Unix hackers are generally stereotyped as computer nerds who wear half-inch glasses. Computer-intrusion hackers are stereotyped as computer nerds who wear half-inch glasses and are bent on trying to start World War III from a pay phone. Software pirates are stereotyped like mad. We're all made out to be half-intelligent people who tYpE LiKe tHiS.

In my exploration of the warez community, I've found many intelligent people. I'll put the emphasis on *intelligent*. I've met people who, as well as pirating, write useful utilities and hang out in the metaphysics chat rooms. And they all know how to use the shift key properly.

ROBIN GOODFELLOW  
*Sova, Fiji*

*i DiDN'T MeaN To iMPLy THaT SoFT-WaRe PiRaTeS aRe HaCKeRS, NoR THaT SoFTWaRe PiRaTeS aReN'T iNTeLLiGeNT. Hey, SoMe oF My BeST FRieNDS TyPe FuNNy.—DaViD PoGue m*

Letters should be sent to *Letters*, Macworld, 501 Second St., San Francisco, CA 94107; via fax, 415/442-0766; or electronically via CompuServe (70370.702), MCI Mail (294-8078), America Online (keyword Macworld), AppleLink (Macworld1), or the Internet (letters@macworld.com). Include a return address and daytime phone number. Due to the high volume of mail received, we can't respond personally to each letter. We reserve the right to edit all letters. All published letters become the property of *Macworld*.



# The World's First Do-It-Yourself Ad.

Rather than try and sell you on  
Canvas 5, we invite you to sell yourself with  
a 30 day free trial offer.

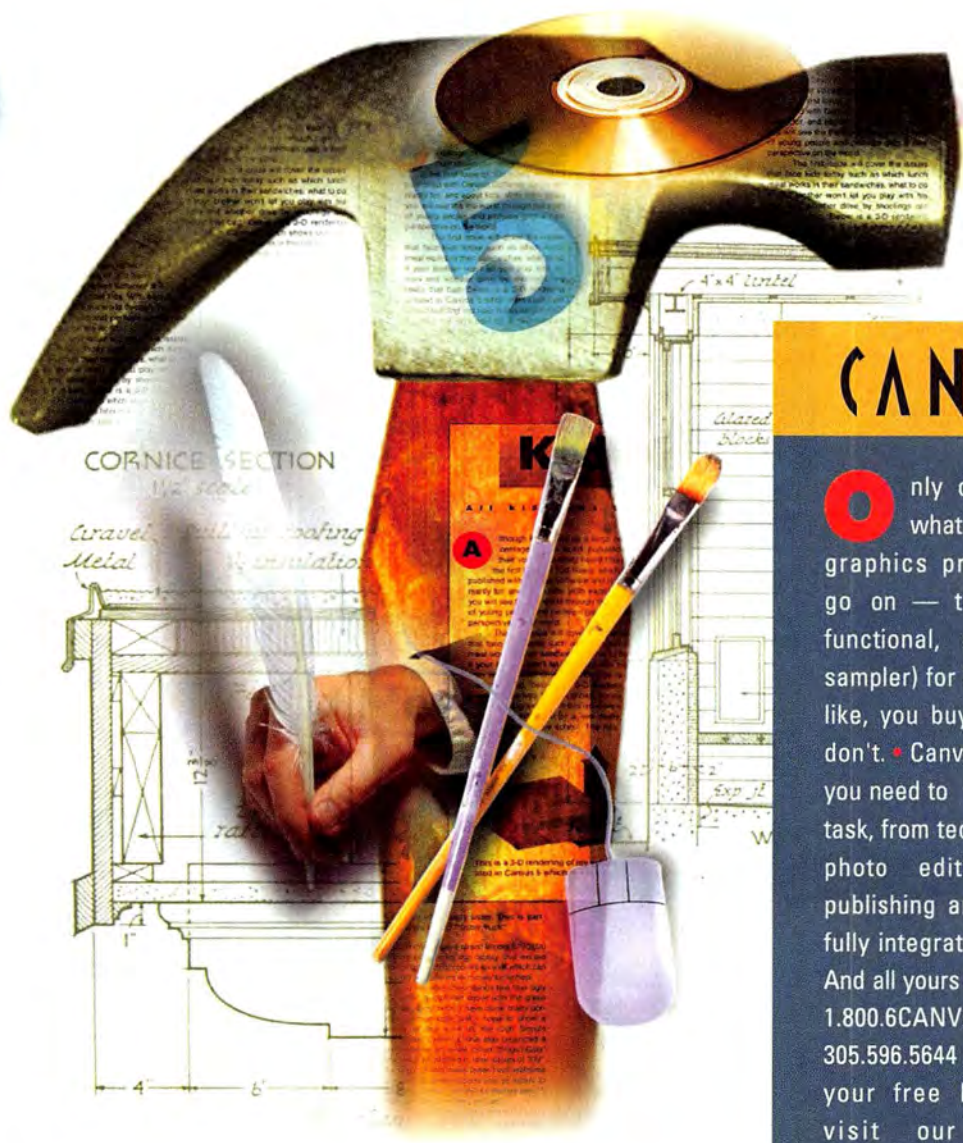

## CANVAS 5

Only one person knows what you want in a graphics program: you. So go on — try Canvas 5 (fully functional, not some weenie sampler) for 30 days, free. If you like, you buy. If you don't, you don't. Canvas 5 has everything you need to tackle any graphics task, from technical drawing and photo editing, to desktop publishing and web design. All fully integrated. All easy to use. And all yours for the asking. Call 1.800.6CANVAS (622-6827) or 305.596.5644 ext. 2, and ask for your free Evaluation CD or visit our web site at [www.deneba.com/macworld/](http://www.deneba.com/macworld/) to download it gratis. And if you've already sold yourself, visit your favorite reseller or call us and pick up a copy today.

© Copyright 1997 Deneba Software. Limited time offer valid only in North America. This ad was made using nothing but Canvas 5. Any questions?



Circle 57 on reader service card



NEW VERSION!

# MiniCAD<sup>®</sup> 7

Windows<sup>®</sup>/Macintosh<sup>®</sup>

The Easiest, Most Cost-Effective Way to Design



For more than a decade, professionals seeking an out-of-box CAD solution have selected the award-winning MiniCAD. This stand-alone program lets you create everything from precise working drawings to sophisticated client presentations



- Precise Sun Positioning
- Expression Evaluation Inside Textboxes
- Automated Databases/Spreadsheets
- Multi-Decimal Dimensioning
- Rotatable Grid and Customizable Coordinate System
- Plus Dozens of Performance and Interface Enhancements

To learn more about MiniCAD's extensive feature set and why the program has been called "the easiest, most cost-effective way to design," call 1-888-MINICAD or visit our Web site: [www.diehlgraphsoft.com](http://www.diehlgraphsoft.com) MiniCAD 7, which retails for a suggested price of \$795, comes with 18 months of FREE Tech Support and a 30-Day Money-Back Guarantee!

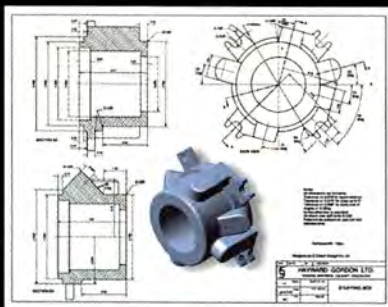

tries—multi-decimal accuracy for precise drafting, a built-in database/spreadsheet to track costs and materials, extensive

Now this total CAD solution speeds your design process with these new features:

- True 3D Boolean Solid Modeling
- DWG and DXF Import/Export
- Dual-Unit Dimensioning
- Auto Wall Framing
- QuickDraw 3D Rendering
- Associative Hatching
- Automatic Wall Joining
- Next-Generation SmartCursor

to extensive materials lists and cost estimates.

As always, MiniCAD 7 offers the same core features that have made it the program of choice for design professionals in more than 80 coun-

tries—multi-decimal accuracy for precise drafting, a built-in database/spreadsheet to track costs and materials, extensive library of industry-specific symbols, cross-platform compatibility (Mac and Windows), and a macro programming language for automating complex and routine tasks.



**MiniCAD 7—The only thing small is the price.**



Circle 46 on reader service card

MiniCad is a trademark of Diehl Graphsoft, Inc. All other brands and product names are trademarks of their respective holders.



# The Vision Thing

by Andrew Gore

## Games without Frontiers

HOW MESA IS PROVING THAT THE MAC REALLY IS A GREAT GAME MACHINE

IT'S A NATURAL TENDENCY to generalize. Generalizations let us make fast decisions when a careful evaluation of the facts isn't practical. Of course, generalizations are usually based on previous experience that may not apply in every circumstance. Take, for example, the prevailing generalization that the Mac is not a strong platform for games. In part, this is true—the installed base of the Mac is smaller than that of Windows 95, so more Windows game titles are sold than Mac titles. However, it doesn't necessarily follow that Mac users are not interested in games or are unwilling to pay for top-quality titles. As it turns out, a new industry organization is working hard to prove another generalization: The Mac is a great game machine.

### View from the MESA

With Apple's release of the Power Macintosh G3, the PowerPC architecture is again proving its superiority over Intel's, not just in speed but also in affordability (see the cover story for all the details). These fast and inexpensive systems will be a boon for content creation. But that's not what has me excited. Making the games scream is what has me champing at the bit for a G3-powered Mac. The only problem is that there seemed to be few hot new titles capable of taking advantage of the processing power of these new machines.

Then I heard about MESA, the Macintosh Entertainment Software Alliance. MESA is a bunch of game developers who were getting tired of the "Macintosh is not a good platform for games" generalization and decided to do something about it. MESA members believed that factors such as poor stocking, uninformed salespeople, and restrictive mail-order practices—not a weakness in the Macintosh itself—were holding back a potentially lucrative market for Mac entertainment titles.

### The Game's Afoot

Key among MESA's initiatives is the effort to improve the economics of selling Mac games through mail-order catalogs. Prior to this effort, game developers could actually lose money selling via mail order. Why? Because they had to pay steep fees to place their products in mail-order catalogs. Because games are low-priced, and therefore low-profit, the cost of an ad in a catalog meant that only runaway best-sellers could make money. A game that sold only moderately well could lose money sold via mail order, which, of course, discouraged developers.

Then MESA got involved and convinced three of the four major Mac mail-

agreed to place the top ten Macintosh games on endcaps and other premium shelves. In addition to making Mac games more visible in these stores, this initiative also gives Macintosh game buyers a freebie: If they buy two of the top ten games, they get a third game (not from the top-ten list, of course) for free.

And those top ten games? *Myth*, *Diablo*, *Starfleet Academy*, *F/A-18 Hornet 3*, *Quake*, *Duke Nukem 3D*, *Shadow Warrior* (sequel to *Duke*), *Jack Nicholas 4*, *Civilization 2* (best-selling strategy game ever), and *Master of Orion*. Just looking at this list is enough to make a Macintosh gamer like me salivate. I can see I'll have many sleepless nights as my new G3 Macintosh and I struggle to meet these sinister challenges!

This could be the best holiday season ever for Macintosh gaming, thanks to the efforts of MESA and a handful of dedicated game developers (for more evidence, see "Great Games," *Macworld's* Game Hall of Fame, in this issue). But if we don't support these products, the Mac may lose developers as well as users. Around 65 percent of Mac users play games, and while it may not be the number one consideration when buying into the platform, it is

a major one. So, if the Mac community doesn't continue to emphasize the Mac's strengths as a game machine, it could lose more users to Wintel, just because they want to play a few good games.

Just in case you doubt the potential strength of the Mac as a game machine: *Duke Nukem*, *Quake*, and *Civilization 2* all paid for their entire development on the first day of sales. ■

*Stop playing games; tell me what you really think by sending your comments to [visionthing@macworld.com](mailto:visionthing@macworld.com).*



order houses to stock games based on what customers want instead of what developers are willing to advertise, and games sales are now going through the roof. The only mail-order holdout is MacWarehouse, which, according to MESA president Peter Tamte, believes games are not important to its catalog.

MESA's second initiative was to heighten the profile of Macintosh games in retail stores, which still sell 70 percent of all Mac games. In a copromotion with Apple Computer, key retailers have



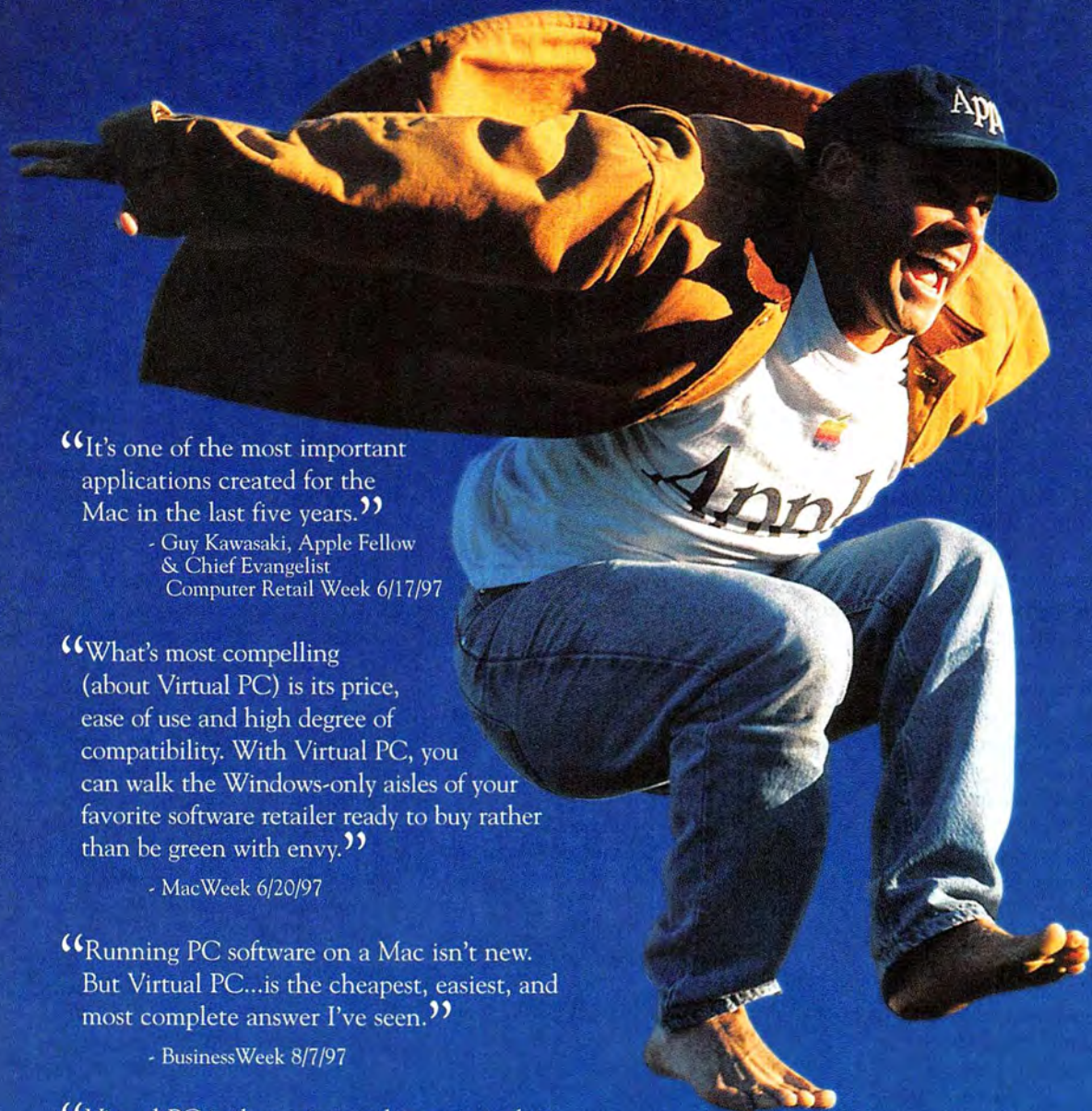

“It’s one of the most important applications created for the Mac in the last five years.”

- Guy Kawasaki, Apple Fellow  
& Chief Evangelist  
Computer Retail Week 6/17/97

“What’s most compelling (about Virtual PC) is its price, ease of use and high degree of compatibility. With Virtual PC, you can walk the Windows-only aisles of your favorite software retailer ready to buy rather than be green with envy.”

- MacWeek 6/20/97

“Running PC software on a Mac isn’t new. But Virtual PC...is the cheapest, easiest, and most complete answer I’ve seen.”

- BusinessWeek 8/7/97

“Virtual PC is the easiest and most complete way to run Windows software on a Mac without spending a fortune.”

- Wall Street Journal 7/17/97



**Connectix**

Makers of RAM Doubler  
and Speed Doubler.

© 1997 Connectix Corporation  
2655 Campus Dr., San Mateo CA 94403 USA  
650-571-5100 • Fax 650-571-5195 • [www.connectix.com](http://www.connectix.com)  
Connectix Virtual PC is a trademark of Connectix Corp.  
All other trademarks are the property of  
their respective holders.





# NOW, JUMP INTO THE OTHER 95% OF THE COMPUTER STORE.

## CONNECTIX VIRTUAL PC PRODUCTS GIVE YOU A WHOLE NEW FREEDOM

You love your Mac, but some software is written only for the PC. Here's the solution.

Connectix Virtual PC™ gives you the freedom to run PC software including games, edutainment titles and productivity applications with playable performance on your Power Mac or clone. Connectix Virtual PC product line offers the first, truly affordable, easy-to-use solution for running the universe of PC applications on your Mac.

Easily installed, Connectix Virtual PC is like having a Pentium® MMX™ PC in software. Use your favorite Mac peripherals because Connectix Virtual PC has built-in support for CD-ROM, printing, networking (ethernet), modem, sound and video. Connectix Virtual PC product line is available in three different versions - Windows 95™, Windows 3.11™ or IBM® PC DOS. You can even run other operating systems such as Windows NT™, IBM® OS/2™ and NeXT® OpenStep™ (not included). Switch instantly between Mac and PC applications.

Get Connectix Virtual PC. Then, run the universe of PC software on your Mac.



THE KEY TO RUNNING  
PC SOFTWARE ON YOUR MAC

◆◆◆◆ MacWEEK  
6/20/97

Circle 192 on reader service card









# For people with 19-inch eyeballs and a 17-inch work space.

## Introducing our latest big idea.

The G790 is the latest innovation from ViewSonic®, a company known for taking the lead. It's one of those rare "best-of-all-possible-worlds" solutions for those who need a larger display area but don't want to compromise either screen performance or desktop space. It's the first 19" display (18.0" viewable) made by ViewSonic, and while its screen size is big, its footprint is small, taking up about the same space as a typical 17" (various viewables) monitor.

## No small-fry when it comes to performance.

For graphics users, web pros, business types and home surfers alike, the G790 is a big performer. It has a super fine 0.26mm true dot pitch and flicker-free optimal resolution of 1,280 x 1,024 at an 88Hz refresh. In other words, it's razor sharp. And with a vertical scan rate of 180Hz, it even displays flawless 3D applications. Check out the G790 for yourself. It's a real eye-opener.

***For the dealer nearest you, call ViewSonic at (800) 888-8583 and ask for agent 81034, or visit our website at: [www.viewsonic.com](http://www.viewsonic.com).***

### **ViewSonic G790**

- 19" Display (18.0" Viewable)
- .26mm true dot pitch
- 1,280 x 1,024 optimal resolution at 88Hz
- TCO Compliance
- SuperContrast™ screen



**ViewSonic®**  
*See The Difference!™*

Circle 59 on reader service card



# News

systems

## Apple Ships Rhapsody to Developers

BUT MAC OS REMAINS  
PRIMARY FOCUS

by Stephen Beale

**A**pple's Rhapsody operating system was back in the limelight in October, when the company shipped the first release of the next-generation OS and a host of vendors announced Rhapsody software. Still, Apple has made it clear that the Mac OS will remain its primary focus for the foreseeable future.

"The Mac OS is and continues to be the mainstream operating system," says Rhapsody product-line manager Ricardo Gonzalez.

Apple announced Rhapsody in January 1997, shortly after its acquisition of Next (see "What's Next for the Mac OS?" *News*, March 1997). The OS would have two components: a Blue Box, for running Mac OS applications, and a Yellow Box, based on Next's OpenStep software, that would offer such modern OS features as protected memory and preemptive multitasking. Although Apple also announced a roll-



out plan for future versions of the Mac OS, it appeared that Rhapsody was getting most of the company's attention.

**Strategic Shift** Months later, Gil Amelio resigned as CEO, Steve Jobs took the reins as de facto chief executive, and Apple shipped Mac OS 8—which sold 2 million copies by mid-October.

Speaking at the August

Macworld Expo in Boston, Jobs signaled that he had shifted emphasis from Rhapsody to the Mac OS. During his keynote, he said that Apple would beef up its investment in the Mac OS. He also told *Newsweek* magazine that "a lot of Rhapsody will be in the Mac OS, rather than the other way around."

Jobs now says Rhapsody

will be Apple's equivalent of Microsoft's Windows NT, first supporting servers and other high-end software that can take full advantage of modern OS features. *MacWeek* has reported that Apple's forthcoming Mac OS-based network computer will be tied to Rhapsody servers.

**Rhapsodized Developer**  
The initial release of Rhap-



# Apple Announces \$161 Million Loss

JOB'S REMAINS COY ON CEO PLANS

by Stephen Beale

sody is not intended for prime time. Instead, it is aimed at vendors who may want to develop Rhapsody-based software or hardware. It does not include the Blue Box for Mac OS compatibility and lacks support for Point-to-Point Protocol, which allows dial-up connection to the Internet.

Still, a host of vendors have announced Rhapsody-based software. Many of the developers already have experience with OpenStep.

Among the new packages are Create, a \$249 design and layout tool from Stone Design (505/345-4800, [www.stone.com](http://www.stone.com)); PasteUp, a \$695 page-layout program from Anderson Financial Systems (215/653-0911, [www.netaxs.com/~afs](http://www.netaxs.com/~afs)); and Glyphix, a drawing and charting program from M. Onyschuk and Associates (416/598-1321, [www.oaai.com](http://www.oaai.com)).

OpenBase International (603/547-8404, [www.openbase.com](http://www.openbase.com)) announced a Rhapsody version of its OpenBase SQL database manager, and Snap Innovation, a German developer, says that it has ported its Prime Base database software to Rhapsody. Dantz Development (510/253-3000, [www.dantz.com](http://www.dantz.com)) announced Rhapsody client software for use with Retrospect, its Macintosh-based backup utility.

**Premier on the Way** Next on Apple's Rhapsody agenda is Premier, which is scheduled for release in early 1998. Premier will include the first implementation of the Mac OS-compatible Blue Box, as well as the QuickTime Media Layer.

Apple also says it will include a version of its AppleScript scripting software in all future releases of the Yellow Box, including Yellow Box versions slated for PCs.

Additional reporting by MacWeek staff.

Steve Jobs's famed reality-distortion field was on full display at the recent Macromedia User Conference, where he received a standing ovation from multimedia developers after hinting that he might be willing to drop the "interim" from his job title and become Apple's long-term CEO. Unfortunately for Apple, even Jobs could not hold back a cold splash of financial reality as the company announced that it had lost \$161 million in the fourth fiscal quarter, which ended September 26.

Most of the loss was due to a pair of onetime charges: \$75 million for the acquisition of Power Computing's Mac business and \$62 million for future restructuring charges. That left an operating loss of \$24 million; analysts polled by First Call had predicted a \$17.8 million loss.

**Disturbing Trends** Behind the numbers were some disturbing trends. Sales continued to decline, as Apple sold 625,000 Macintoshes, compared with 932,000 in the same quarter a year ago. Apple Chief Financial Officer Fred Anderson blamed this situation in part on a shortage of the fastest PowerPC chips, leading to a \$200 million backlog of orders for Apple's most profitable high-end Macintoshes.

Education revenues went flat at a time when PC makers were increasing their K-12 sales, reducing Apple's share in one of its most important markets. Sales in Japan, another key Apple market, plummeted 50 percent from

the same quarter a year ago.

Overall revenue was \$1.6 billion, down 30 percent from \$2.32 billion in the fourth quarter of 1996. For the year, Apple lost about \$1 billion on sales of \$7.1 billion, compared with 1996 losses of \$816 million on sales of \$9.8 billion.

Apple suffered the losses despite strong sales of Mac OS 8. Also on the plus side, Anderson said that quarterly operating expenses were \$353 million, down \$55 million from the previous quarter. Apple continues to have strong reserves, with about

*continues on page 30*

## Apple's New Channel Program

BY LEANDER KAHNEY, MACWEEK

HOPING TO SPUR GROWTH WHILE CUTTING OPERATING EXPENSES, Apple recently announced that it is shaking up its relationship with resellers and its methods of supplying them.

Apple acknowledges that sales have suffered from a lack of Mac advocacy among resellers, especially computer superstores, and from problems in getting products to market. Mitch Mandich, senior vice president of Apple Americas, says that Apple will boost Mac advocacy by increasing the number of dealers buying directly from the company.

**Going Small** To do so, in December Apple will reduce its requirement for direct purchases from \$20 million in direct purchases annually to \$2 million. The lower requirement will attract smaller dealers, who Mandich says are generally more committed to the Macintosh than superstores.

He also says that Apple will remove restrictions on the type of products dealers can sell. Previously, the retail channel was generally restricted to selling consumer machines, while value-added resellers were restricted to high-end products. Mandich says resellers will have access to the full range of Apple's goods, with the exception of education-specific products.

The company also hopes to see significant savings in inventory management by changing its return and price-protection policies, Mandich says. Apple reduced the amount of unsold goods resellers can return, from 10 percent to 5 percent, and said it will guarantee product prices for 30 days. Previously, Apple protected only products in inventory or transit.

The move is designed to encourage the channel to turn products over faster by placing greater responsibility for managing inventory in dealers' hands, says Michael France, a member of Apple's new Apple Dealer Association board and a senior partner at MacCenter, a reseller based in Fort Lauderdale, Florida.





# Special REPORT

## Coming Soon to a Service Bureau Near You

DIGITAL PRESSES AND LARGE-FORMAT SYSTEMS TRANSFORM IMAGING SERVICES

A few years ago, your service bureau probably earned most of its revenue by offering imagesetter film output and other prepress services. Today, many of these firms are transforming themselves into digital-printing centers with high-speed copiers, digital presses, and large-format output systems. In this special report, *Macworld* looks at emerging technologies that are well on their way to taking the *pre* out of prepress.

### Digital Presses Get Personal

by Stephen Beale

**D**igital presses are nothing new. The first models, Indigo's E-Print 1000 and Xeikon's DCP-1, were introduced in 1993 and soon began proliferating in service bureaus seeking new lines of business. However, graphics professionals have been slow to take advantage of the presses' unique functions, such as the ability to produce personalized documents with variable text and graphics. A major problem has been the lack of easy-to-use personalization software, but things are changing with recent announcements of variable-data programs that work with QuarkXPress and other graphics software.

Digital presses use a variety of methods to produce high-quality color output at speeds approaching those of conventional offset equip-

ment. Most digital presses are based on the same technology found in color copiers; some high-speed copiers, such as Canon's 30-pages-per-minute CLC 1000, could be considered digital presses. Because they produce output directly from digital data, the presses can vary the text and graphics on each page in a print job—if you have the appropriate software.

**Mail Merge Plus** Personalization software could be thought of as mail merge on steroids. A mail-merge program lets you insert variable data—such as a name and address—into direct-marketing pieces and other documents. A personalization program lets you place variable photos and illustrations as well as text to produce customized graphics-laden documents for specific recipients.

The benefits should be easy to see. In an early demonstration of personalization at the 1995 Seybold San Francisco conference, Apple representatives used QuarkXPress, AppleScript, and an Indigo E-Print 1000 to produce customized flyers for a fictional Macintosh promo-

tion aimed at college women and male corporate executives. The former featured a photo of a young woman in an outdoor setting, while the latter showed a middle-aged man sitting at a desk. Each flyer also included the names of Macintosh dealers in the recipient's area.

Currently available personalization programs vary widely in price and capability, but the basic approach they use is the same. First you create a page layout, generally using QuarkXPress. You place the constant text and graphic elements—those that remain the same on each page—and then add empty text and picture boxes for variable data, linking these to fields in a

**Focus Gold** Vision's Edge (904/386-4573, [www.xtender.com](http://www.xtender.com)), a QuarkXTensions developer, announced its Focus Gold personalization program at the 1997 Seybold San Francisco. Originally created for *Reader's Digest*, the \$2,000 QuarkXTension works with Claris FileMaker Pro to produce personalized documents. A visual interface lets you set up formulas and conditions for varying text, graphics, and rule widths. The program supports any PostScript-compatible output device, but the company says it is also working with digital-press vendors to create custom performance-enhanced versions for their equipment.

In March, Vision's Edge plans to release a simplified version called Focus Silver; the price will likely be between \$500 and \$600.

**PrintShop Mail** Splash Technology (408/328-6300, [www.splash.com](http://www.splash.com)), a vendor of Mac-based print servers for Xerox color copiers, is offering PrintShop Mail, a personalization program that it sells with its Splash

systems. Oldsmobile is using the software, along with Apple's WebObjects, to provide potential buyers of its Intrigue model with information customized to their purchase preferences. Customers at Oldsmobile dealers enter color preferences and other information into a database, eventually producing a custom Web page and a specifications booklet.

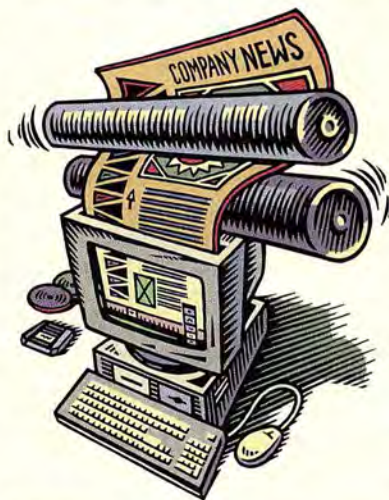

database. Some programs offer sophisticated conditional-graphics functions, such as changing the width of a rule based on information in a database field.

Once you've completed the layout, you send the QuarkXPress file and the database to your service bureau, which then prints the finished, customized documents.



PrintShop Mail, developed by Atlas Software ([www.atlassoftware.nl](http://www.atlassoftware.nl)), of the Netherlands, works with PostScript files created in a word processor or page-layout program. Atlas offers a stand-alone version for Xerox and Canon copiers; you pay \$1,395 for up to 200,000 prints or \$3,995 for unlimited prints. A demo version is available on the company's Web site.

**Fiery FreeForm** Electronics for Imaging (650/286-8600, [www.efi.com](http://www.efi.com)) has announced a personalization program called Fiery FreeForm Variable Data Printing that works in conjunction with its Fiery controller for digital color copiers. The software can customize multiple-page documents and lets you add transparent or opaque variable elements.

These are just a few of the personalization programs now available, and more are likely to follow. All require extensive interaction with your service bureau. In some cases, you may not have to purchase the software; instead, you can set up the database and QuarkXPress layout and let your service bureau handle the rest. Always be sure to discuss your project requirements with your service bureau before investing in any personalization software.

**Design Impact** Personalization programs raise interesting issues for designers. When you design marketing materials with static text and graphics, it's easy to see how the elements work together. With personalization, designers will have to create pages that look good with varying combinations of photos and illustrations. But given the obvious advantages of variable-data printing, many designers will no doubt welcome the challenge.

## Ink-Jets Make Large Strides

by Andrea Dudrow

Large-format electrostatic printers have long been the workhorses of service bureaus offering poster-size output. Given their fast printing speeds and durable output, service bureaus were willing to overlook their drawbacks, such as the \$50,000 to \$100,000 price tags. The first large-format ink-jet printers, while much less costly than electrostatic ones, were slow and limited to producing indoor graphics. Today, a new generation of ink-jet printers is quickly advancing on electrostatic territory with faster print speeds, higher resolution, and inks that resist fading in sunlight.

**Piezo Prints** CalComp (714/821-2000, [www.calcomp.com](http://www.calcomp.com)), Raster Graphics (408/232-4000, [www.rgi.com](http://www.rgi.com)), and Xerox ColorgrafX (408/229-3929, [www.xerox.com](http://www.xerox.com)) have each introduced large-format printers based on piezoelectric technology, which uses pressure instead of heat to place ink on the paper. In addition to being faster than older ink-jet printers, these offer resolutions up to 720 dpi; most other large-format ink-jet printers are limited to 300-dpi output. All are priced between \$20,000 and \$30,000.

One of the first large-format piezoelectric ink-jet printers was the \$19,995 PiezoPrint 1000 from Raster Graphics, which the company announced about a year ago. The printer, actually manufactured by Mimaki, handles

paper up to 52 inches wide and uses pigment-based inks that resist fading in sunlight.

The printer is bundled with PosterShop PS, a Macintosh-based raster-image processor (RIP) from Onyx Graphics. The RIP acts as an intermediary between the computer and the printer.

**Xerox and CalComp** More recently, Xerox ColorgrafX introduced the VivagrafX Xpress, a \$29,995 device that



prints on media up to 36 inches wide. The printer can hold up to three rolls of paper. Output speed ranges from 40 to 160 square feet per hour depending on resolution. The price does not include a RIP; Xerox offers a \$6,000 NT-based RIP for the printer, but RIPs are available from other vendors as well.

CalComp's new CrystalJet is available in two versions, a \$21,995 model with a maximum paper width of 42 inches and a \$29,995 model that handles paper up to 54 inches wide. The printer includes a built-in PostScript interpreter, but CalComp expects most service bureaus will add their own RIPs for faster throughput. One unique feature is an LCD screen that shows video clips on common printer maintenance tasks. Output speed ranges from 72 to 240 square feet per hour depending on resolution.

**Extra Ink** The latest DisplayMaker printers from ColorSpan (formerly Laser-

Master; 612/944-9330, [www.colorsapan.com](http://www.colorsapan.com)) print at 300-dpi resolution but have eight inks instead of four; you can add light and medium cyan and magenta inks to achieve photographic resolutions equivalent to 1,200 dpi, ColorSpan says. The extra ink wells can also be used for switching between traditional dye-based inks and new pigment-based inks for outdoor graphics. The units are available in 42-, 52-, and 60-inch widths for \$17,995, \$21,995, and \$27,995, respectively.

### For the Rest of Us

For designers who would like to bring large-format printing in-house, Hewlett-Packard (800/752-0900, [www.hp.com](http://www.hp.com)) has introduced the DesignJet 455CA,

a \$4,195, 36-inch printer that offers a maximum color resolution of 300 dpi. The price includes a Macintosh-based software RIP and a JetDirect RX external print server for speedy throughput.

**Customer Benefits** Thanks to these new ink-jet printers, service-bureau customers can expect more choices and faster, better-quality poster-size output.

With their increased resolution and, in some cases, extra colors, these printers could begin competing with high-end Iris Graphics ink-jet printers for fine-arts output. Grey Held, a senior analyst with Lyra Research, says that Hewlett-Packard and Raster Graphics have made big strides in image quality, especially for photographic output. Iris printers are "still the cream of the crop in terms of quality," Held says. But he believes that large-format ink-jet printers will eventually match the quality of Iris printers.



# Sneak PEEK

## Dreamweaver Brings HTML to Life

BY JASON SNELL

In the fast-moving world of the Web, today's top HTML editor can be tomorrow's roadkill. The latest contender for the crown is Macromedia's Dreamweaver, a WYSIWYG editor due in December that creates animated, CD-ROM-style Web pages using a new version of HTML called Dynamic HTML.

Like CyberStudio and NetObjects Fusion, Dreamweaver (\$299 through February 1998, \$499 after) lets you design Web pages by dragging items on a page. But while those programs use complex HTML tables, Dreamweaver uses a new HTML feature, absolute positioning, to place objects with pixel-level accuracy. It also supports cascading style sheets, which lets you apply styles to a Web page or an entire site via a floating Style palette.

There's even CD-ROM-style interactivity: Via the Timeline Inspector, you can make text and graphics slide across a page or appear and disappear when you click on a link.

**Hands off the Code** Web authors will appreciate Dreamweaver's hands-off approach to HTML code—we found that unlike with most WYSIWYG editors, opening several complicated pages revealed only a few rewritten tags. The tags Dreamweaver changed contained errors, which Dreamweaver corrected. Another plus is Dreamweaver's tight integration with Bare Bones Software's excellent BBEdit text editor, which is bundled with it. A library stores commonly used fragments of HTML code such as headers and footers. When you change an element in the library, Dreamweaver can automatically make that change on every other page in your site.

There are drawbacks to being a Web pioneer, though: Dynamic HTML pages require Internet Explorer and Navigator versions 4.0; older browsers see only a mishmash of text and graphics. In contrast, CyberStudio and Fusion's layout methods are compatible with most Web browsers in use today. Plus, Dreamweaver's interface for creating and editing older, more-common HTML tags such as tables doesn't seem as strong as either CyberStudio's or PageMill's. And much of Dreamweaver's impact has to do with being the first WYSIWYG editor to support Dynamic HTML. But will it be king of the hill in a few months? As is always the case in Web time, that's anyone's guess.



You can animate objects in Dreamweaver by selecting an item and moving it within the Timeline window.

### multimedia

## Macromedia Unplugged

ANNOUNCES UNIVERSAL MEDIA INITIATIVE AT USER CONFERENCE

by Stephen Beale

Looking to end the proliferation of browser plug-ins, Macromedia (415/252-2000, www.macromedia.com), used its annual conference in October to announce a Universal Media Initiative that will let you view ShockWave and Flash animations—and other forms of dynamic media—without special playback software. Designers can now make animated Web sites accessible to users who don't have the necessary plug-ins.

The company's goal is to adapt its multimedia authoring tools to such Web standards as Java and Dynamic HTML. The latter, supported in the latest versions of Netscape Navigator and Microsoft Internet Explorer, lets you create Web-based animations by using HTML codes.

One early fruit of this initiative is Macromedia's new Dreamweaver Web authoring software (see "Dreamweaver Brings HTML to Life," at left), which supports Dynamic HTML. But Macromedia has also extended its efforts to its other multimedia tools.

**Java Playback** A forthcoming Java Export Xtra for Macromedia Director 6.0 and 6.0.1 will enable you to convert Director files into Java applets that can be viewed in any Java-compatible browser. Macromedia plans to ship the Xtra in early 1998. Pricing

has not yet been determined, but Macromedia will offer the Xtra at no charge to users who purchase or upgrade to Director 6 before the end of 1997.

Macromedia's new Flash Player Java edition lets you generate Java applets that contain Flash vector animations. The software is available now as a public beta from Macromedia's Web site; the final version will ship for free by year's end.

**Aftershock** Macromedia also announced Aftershock, a technology that allows Web



designers to set up playback hierarchies based on the capabilities of particular browsers. If you create a Flash animation, you can set it up to play first through the Shockwave Flash plug-in. If the user hasn't downloaded the plug-in, the animation will play as a Java applet. If the user doesn't have a Java-capable browser, the animation will play as an animated or still GIF.

The Flash Aftershock utility is now available on Macromedia's Web site. Macromedia plans to release a Director Aftershock utility by the end of the year.

The company isn't giving up on plug-ins, which still offer the fastest playback of Shockwave and Flash media. In addition, the Java applets are missing some features supported in the plug-ins, such as the ability to play stereo audio.

Macromedia also an-



nounced the FreeHand Animation PowerPack, a \$39 collection of Xtras that allow direct export of Flash animations from FreeHand. One Xtra transforms FreeHand blends into Flash-animated vector morphs.

**Sneak Previews** One conference session offered a look at features likely—but not guaranteed—to appear in future Macromedia products, including FreeHand 8.

FreeHand users can look forward to an Image Hose, similar to the one in Fractal Painter; a customization option that lets you define your own keyboard shortcuts and tool bars; a tool that lets you reshape paths without dragging Bézier control points; and a feature that lets you rotate objects as you mirror them.

Company representatives also previewed transparency capabilities for Flash animations, quiz-building tools for Authorware Professional, and the PowerPoint Import Xtra for Macromedia Director.

## graphics

# New Order from Xaos

GRAPHICS SOFTWARE DEVELOPER TO ENTER CONSUMER MARKET

by Rebecca Gulick, MacWeek

**X**aos Tools (415/477-9300, [www.xaostools.com](http://www.xaostools.com)) has unveiled a new graphics engine that unifies disparate graphics types. The engine is propelling Xaos in a new direction as well; the company will enter the consumer photo-editing market with a new product later this year.

"We're basically back as

a company with new technology," says Xaos president Bob Batty.

Xaos's new "imaging substrate" will serve as the power behind the company's product line. Under construction for more than three years, the engine and a new scripting language will unify raster and vector technology, 2-D and 3-D graphics, and still and moving images, Batty says.

**Flashy Images** Flash Box will be Xaos's first product based on the new technology. The \$99 image-editing tool will make its Mac debut in January.

The stand-alone application will feature a drag-and-drop interface. Each tool will have its own semitransparent palette of brushes, and all components will reside in animated slide-out shelves.

Flash Box will feature seven thematic Flash Xubes, modules that contain tools and other components. A set of retouching tools will remove red-eye and scratches, adjust blur and sharpen levels, and correct brightness and color saturation. Another set will create morphing effects.

Users will be able to download 12 additional sets of tools and content—one per month for a year—at no extra cost. However, Flash Box will not support Adobe Photoshop plug-ins.

**For the Pros** While Flash Box is aimed at consumers, Xaos says it will continue to focus on professional graphics plug-ins. Four special-effects products are slated for release in 1998, including Phenomenon, a tool for creating climatic effects for still and moving images. It will support a variety of 2-D, 3-D, and video packages, Xaos says. The company also plans to upgrade its existing \$199 plug-ins—Paint Alchemy, Terrazzo and TypeCaster—to the new engine.

## systems

# Omega Touts Own Mac OS

MYSTERY SURROUNDS

GERMAN DEVELOPER OF MAC-COMPATIBLE OS

by Matthew Rothenberg, MacWeek

**T**he air of mystery surrounding upstart German developer Omega ([www.omega.de](http://www.omega.de)) continues to deepen as international Macintosh enthusiasts ponder the company's claim that it has created a

Macintosh-compatible OS from scratch.

Omega, based in Stollberg, Germany, has posted information on its Web site about COS, a new operating system that the company says will run in 4MB of RAM on 680X0- and PowerPC-based Macs equipped with a float-point unit.

Omega says the \$99 software will include its own microkernel and offer four times the performance of Mac OS 8. It will run all Mac OS 7.6- and Mac OS 8-compliant software and include a complete 680x0 emulator, Omega says.

"The first version will

*continues*



ARNOLD TOISEIO

## New Projector Is Bright and Light

IN FOCUS LP420 PUMPS 400 LUMENS

In Focus (503/685-8888, [www.infocus.com](http://www.infocus.com)) is advancing the multimedia-projector revolution with the introduction of the LP420, which offers a bright picture in a case that's light enough to take on the road. The projector pumps 400 lumens from a seven-pound case and has a maximum resolution of 800 by 600 pixels. It is In Focus's first projector to use Texas Instruments' digital light processing (DLP) technology (see "Mirror, Mirror on the Wall," *News*, March 1996). Other DLP projectors have similar designs, often requiring a larger case because Texas Instruments supplies all the components. With the LP420, Texas Instruments supplies the DLP chip and drive-board but In Focus does the rest. In Focus has also added a white panel to the projector's color wheel, which the company says will increase overall brightness. The LP420 lists for \$5,999 and connects directly to your Mac.—ANDREA DUDROW



# Sneak PEEK

## Bryce 3D Moves Mountains

BY CATHY ABES

Curiously renamed Bryce 3D, the long-anticipated upgrade of the 3-D landscape generator from MetaCreations (805/566-6200, [www.metacreations.com](http://www.metacreations.com)), finally provides what its two predecessors lacked: movement. Anything in Bryce 3D can be animated and keyframed; beyond objects and their paths, you can also keyframe textures and effects. Objects can be linked so they move together, and you can have a camera or light link to an object or track it, just by clicking on the Link or Track button and dragging between the two elements.

**Simulating Nature** It's easy to create animated terrains that evolve over time and mimic nature; Bryce 3D allows you to build up mountains and oceans and just as easily erode them into flat plains or deep valleys; for example, I was able to transform a mountain into a volcano by using a brush to erode its center.

You can also simulate such natural phenomena as sun, moon, clouds, stars, and comets. For example, you can add surface detail and rings to the moon, make the moon and stars become visible as the sky darkens, and enlarge the sun or moon as it approaches the horizon.

After you've made your animation, you can enter Bryce 3D's Advanced Motion Lab to alter your object's velocity; view your entire timeline; or cut and paste, remove, or reposition keyframes. You can also preview your animation.

**Fly-through Textures** Bryce 3D's second-most-important addition has to be its revamped textures. Whereas Bryce 2 made you settle for surface textures that merely wrapped around



In Bryce 3D's Advanced Motion Lab, you can change an object's velocity and direction by creating and dragging points on the object's motion path.

objects, Bryce 3D's Hyper-textures are volumetric textures with three-dimensional properties—so, for example, your camera can actually fly through clouds. What's more, any texture imported from Bryce 2 can be easily transformed into a Hyper-texture. And instead of Bryce 2's flat planes, the new version

features 3-D "infinite slabs" that have depth. You can also transform one material into another, which Bryce accomplishes by progressively adjusting such properties as color, texture, and opacity. The ability to quickly and easily animate Bryce scenes and the addition of volumetric textures make this upgrade worth the wait. Due by the end of November, Bryce 3D retails for \$299; upgrades are \$99.

have a very simple desktop: nothing with gimmicks or funny things that cut down the performance," says Omega president Manfred Schmitz.

Schmitz claims that COS includes no code from Apple.

German sources say they are puzzled at the news coming out of Omega. The company, based in eastern Germany, reportedly is a newcomer to the closely knit Mac-developer community centered in western Germany.

### printers

## Laser Printers Speed Along

HP AND XEROX UNVEIL HIGH-SPEED PRINTERS FOR WORKGROUPS

by Macworld Staff

Color may be the rage, but most offices still have use for black-and-white laser output, especially from high-speed network printers. Hewlett-Packard (619/487-4100, [www.hp.com](http://www.hp.com)), which dominates the workgroup-printer market, has introduced its latest LaserJet series, while Xerox (716/265-5697, [xerox.networkprinters.com](http://xerox.networkprinters.com)) is challenging HP with two new printers, one of which blazes along at 32 pages per minute.

**Latest LaserJet** HP's new LaserJet 4000, which replaces the LaserJet 5, prints at 17 ppm and uses the company's FastRes 1,200 resolution-enhancement technology to increase effective reso-

lution from 600 to 1,200 dpi. It supports Adobe PostScript Level 2 through emulation software that HP acquired from Xionics. An instant-on fuser mechanism reduces startup time to 15 seconds, HP says.

The printer uses HP UltraPrecise toner cartridges, which yield 10,000 pages each. The cartridges feature smaller toner particles—5 to 6 microns—than previous HP cartridges.

HP offers the printer in four configurations: the base LaserJet 4000, which sells for \$1,099; the \$1,249 LaserJet 4000 T, which includes an extra paper tray; the \$1,399 LaserJet 4000 N, which includes your choice of an Ethernet or LocalTalk connection; and the \$1,599 LaserJet 4000 TN, which includes the extra tray and networking.

**Speed from Xerox** Xerox's new DocuPrint N32 and N24 feature 600-dpi resolution, built-in Ethernet interfaces, and an Adobe-licensed PostScript interpreter. The \$2,400 N24 prints at 24 ppm; the \$2,900 N32 speeds along at 32 ppm. Xerox offers several options for the printers, including a \$550 duplex module that lets you print on two sides, and a \$1,970 finishing unit that can staple documents in three different positions.



HP has introduced the LaserJet 4000.



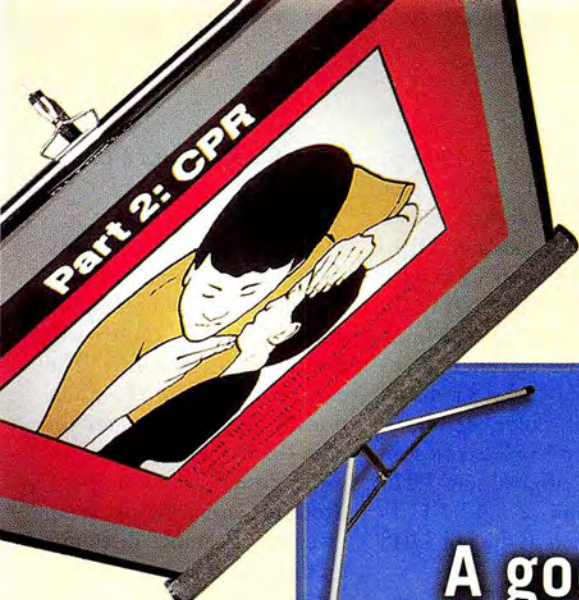

**1** IN AN EMERGENCY, split-second decisions mean the difference between life and death. Not surprisingly, then, the Red Cross puts a tremendous amount of importance on training and preparedness.



## A good projector can save a meeting. A great one just might save a life.

**2** FOR MORE THAN A CENTURY, the Red Cross has been quick to lend a helping hand. In addition to disaster relief, they present comprehensive health and safety programs such as CPR, HIV/AIDS education and Nurses certification programs. In fact, the Red Cross is a leading provider of such health and safety courses.

MultiSync MT LCD Projectors		
	MT810	MT1000
Resolutions Supported	640 x 480, 800 x 600, 1024 x 768 with AccuBlend™ technology	640 x 480, 800 x 600, 1024 x 768, 1280 x 1024 with AccuBlend™ technology
Video Compatibility	NTSC, PAL, SECAM, NTSC 4.43	NTSC, PAL, SECAM, NTSC 4.43
Brightness	550 ANSI Lumens	450 ANSI Lumens
Weight	15.5 lbs	15.9 lbs
Dimensions (W, H, D)	15.6 x 5.7 x 12.6"	15.6 x 5.7 x 12.6"
Both models are compatible with PC, Mac, and workstation computers, feature built-in audio and 2 years of InstaCare 24 hour replacement service.		

Hurricanes. War. Floods. While some would run the other way, the Red Cross rushes in. What makes this extraordinary responsiveness possible? Their generous spirit, and an astonishing amount of training.



NEC MultiSync MT810 and MT1000 LCD Projectors

At NEC Technologies, we salute the Red Cross' incredible commitment to training. For it is our own commitment to training and presentations that led us to develop our new MultiSync® MT810™ and MT1000™ LCD projectors. These compact products offer the highest quality image under all lighting conditions. Simple on-screen menus

plus a hand-held remote make them very easy to use. They're backed by NEC's InstaCare™ 24-hour replacement service. And an introductory video gets you up and running quickly.

All of which makes them the ideal LCD projectors—whether you're training for a disaster, or just trying to keep your next presentation from becoming one. For a free guide to selecting the right projector, call us at 1-800-NEC-INFO. Or visit [www.nec.com](http://www.nec.com). Expect more. Experience more.



**4** IN A DISASTER, one of the things that helps give you peace of mind is the rigorous training of the Red Cross. In a presentation, one of the things that helps give you peace of mind is the superior performance of the new MultiSync MT LCD projectors (not to mention their reliability and incredible ease of use).

**3** THE RED CROSS IS IN THE BUSINESS of saving lives. In some ways, perhaps, one could argue that we are as well. You see, the new MultiSync MT Series LCD projectors are so reliable that they're backed by a whole new level of customer service. It's called InstaCare service from NEC Technologies. And in the unlikely event of a problem, it guarantees a replacement projector within 24 hours at our expense.





publishing

## Scanners on the Move

NEW MODELS FROM  
MICROTEK, EPSON,  
UMAX, AND POLAROID  
by Macworld Staff

With the recent proliferation of digital cameras, you may think that enthusiasm is waning for their technological cousins, CCD flatbed scanners. But just as digital cameras are getting better and cheaper, so are scanners.

Microtek (310/297-5000, [www.microtekusa.com](http://www.microtekusa.com)), Epson (310/782-0770, [www.epson.com](http://www.epson.com)), and Umax (510/651-4000, [www.umax.com](http://www.umax.com)) have all introduced relatively inexpensive flatbeds aimed at reducing your reliance on your service bureau's drum scanner. Meanwhile, LinoColor (516/434-2000, [www.linocolor.com](http://www.linocolor.com)) has announced a trade-in program for its flatbed scanners, and Polaroid (716/256-4436, [www.polaroid.com](http://www.polaroid.com)) has introduced a \$10,000 scanner that can handle transparencies up to 4 by 5 inches.

**Two-Plate Special** Microtek's ScanMaker V TwinScan offers 48-bit color depth and a maximum optical resolution of 1,000 by 3,000 dpi. Software interpolation boosts the apparent resolution to 8,000 by 8,000 dpi.

The flatbed scans reflective originals at up to 11 by 14 inches but also features an internal Twin Plate for transparency scanning. The plate, which lets you scan without a glass between the film and the CCD image sensor, includes holders for 35mm slides, film-

strips, and 4-by-5-inch and 8-by-10-inch transparencies. The ScanMaker V was scheduled to ship in mid-December for \$2,500 to \$3,000.

**Two from Epson** Epson has two new scanners, a \$300 model for SOHO users and a \$2,500 flatbed for graphics professionals. The entry-level Perfection 600 features a 600-by-1,200-dpi optical resolution, 30-bit color depth, and a legal-size scanning bed. Bundled software includes Visioneer PaperPort, Adobe PhotoDeluxe, Xerox TextBridge, and Adobe PageMill. An optional transparency adapter costs \$200.

The tabloid-size Expression 836XL, with its 800-by-1,600-dpi optical resolution and 36-bit color depth, is targeted at graphic-arts production. The scanner includes an

autofocus feature and a pin system for precise alignment of originals. A Text Enhancement Technology feature improves optical-character-recognition accuracy. A transparency adapter costs \$500.

**Umax Power** Umax has introduced the latest in its PowerLook series, the PowerLook III and the PowerLook 3000. Both are aimed at graphics professionals; the PowerLook 3000 in particular is positioned as a low-cost alternative to drum scanners.

The PowerLook III, featuring 1,200-by-2,400-dpi resolution and 42-bit color depth, handles transparencies up to 4 by 5 inches and reflective originals up to 8.5 by 11.7 inches. It sells for \$3,995.

The \$7,000 PowerLook 3000 offers a maximum resolution of 3,048 by 3,048 dpi and 42-bit color depth. A dual-lens system lets you scan letter-size originals at 1,220 by 3,048 dpi or 3.4-by-11.7-inch originals at the full 3,048 by 3,048 dpi.

Both scanners are bundled with Binuscan's PhotoPerfect Master color-correction software.

**LinoColor Trade** LinoColor, which sells relabeled Umax scanners with its own image-capture and color-correction software, has announced a trade-in program for its scanner cus-

tomers. The Precious Gems program offers what LinoColor describes as "substantial credits" toward the purchase of a new LinoColor scanner when you trade in your old one.

**Polaroid Slides** The \$10,000 SprintScan 45 Pro, from Polaroid, handles transparencies up to 4 by 5 inches. It samples images at 36 bits per pixel at 2,000-by-4,000-dpi optical resolution. The scanner is bundled with Binuscan's PhotoPerfect Master software.

## "APPLE ANNOUNCES LOSS"

continued from page 23

\$1.45 billion in cash and short-term assets on hand.

Anderson again refused to predict when Apple will return to profitability. The current fiscal quarter—traditionally Apple's strongest for sales—could be bumpy, because Power Computing and Motorola are offering steep inventory clearance discounts on their clone systems.

**Executive Follies** Amid the losses, Apple's executive exodus continued, as the company announced the departure of Dave Manovich, senior vice president of international sales, and James McCluney, senior vice president of worldwide operations. Replacing Manovich on an interim basis is Mitch Mandich, senior vice president for North American sales. Heidi Hedlund, senior director of operations/product management, is the acting chief of worldwide operations.

Meanwhile, Jobs is doing a slow dance around the CEO position; he's currently the interim CEO but has repeatedly stated that he is not interested in taking the role on a long-term basis.

During a Q&A session following his keynote at the Macromedia User Conference, Jobs was asked if he would drop the "interim" from his job title. His response—that he would "think about it" during an upcoming vacation in Hawaii—fueled speculation that Jobs had decided to take the post. But a week later, Apple spokeswoman Katie Cotton warned against reading too much into his comment. "He only said he was going to Hawaii to take a walk on the beach, chill out, and think," she said.

Additional reporting by MacWeek staff.



Umax's PowerLook III features 1,200-by-2,400-dpi resolution.



# Remembering Cary Lu

by Cathy Abes

Cary Lu, one of *Macworld's* most respected and prolific contributing editors, was diagnosed with inoperable cancer last January. On September 23, 1997, he lost his nearly yearlong battle with the disease, just a few months shy of his 52nd birthday.

Cary was probably best known to *Macworld* readers as the author of the *PowerBook Notes* column, which ran from February 1993 through January 1996. But his contributions to *Macworld*—and the Macintosh community—went far beyond that. He regularly answered readers' questions on *Macworld's* America Online forum and presided over the *PowerBook* panel at *Macworld* expos. An excerpt from his *Apple Macintosh Book* (Microsoft Press, 1984) appeared in our first issue.

**Hands-on Knowledge** Though *PowerBooks* were a favorite topic of Cary's, his broad knowledge extended to many other subjects. After the demise of his column, he wrote numerous in-depth articles on a wide range of hardware, including scanners, digital cameras, displays, projectors, storage and communications devices, and printers.

Cary's expertise went much deeper than that of most writers. He thoroughly tested everything he wrote about, made sure he understood exactly how and why it worked, and did his best to ensure that by the time you finished reading his article, you did, too.

Flawed hardware never fazed him. He could resolder defective circuit boards, fix faulty monitors, and rewire errant cables. When a connector or peripheral did not seem to exist, he figured out how to make his own. For example, in his last *PowerBook Notes* column, he showed how to make a cable adapter for Apple's Plain-Talk microphone that would enable it to work with then-current *PowerBooks*.

Cary was equally knowledgeable about that other platform. During the blitzkrieg surrounding the rollout of Windows 95, he was one of the experts asked by news media for his opinion of that "wonderful" new operating system. Cary's characteristically succinct reply was probably the best sound bite of the day: "Windows 95 is about two-thirds of a Mac."

A perfect illustration of his reasoned approach to the battle then raging between Mac and PC advocates was an article titled "Computing's Holy War" (*Seattle Times*, June 18, 1995; [www.macworld.com/more/](http://www.macworld.com/more/)), comparing Windows-based PCs—for the most part, unfavorably—with the Mac. Typically, Cary didn't proselytize; he just stated the facts and built solid arguments around them. The result resonated strongly with Mac users. The Word file he sent me containing the positive e-mail responses he'd received was 71 pages long.

**An Ultracritical Eye** Never one to be swayed by marketing hype, Cary was renowned for asking vendors the tough



Typically, Cary didn't proselytize; he just stated the facts and built solid arguments around them. The result resonated strongly with Mac users.

questions about their products' capabilities and worth. As they struggled to satisfy his concerns, he would eventually get them to admit that perhaps they still had a few holes to plug.

But Cary's long stint as a technology writer and editor—first with *High Technology*, then *Inc.* and *Inc. Technology* magazines, and later *Macworld* and *PC World*—was only one of his many careers. Armed with physics and biology degrees, he began as a scientist whose research in visual perception and technology at Bell Laboratories led him into television and filmmaking for educational programs like *Infinity Factory*, *Sesame Street*, and *Nova*. His many other areas of expertise included art, photography, Chinese cooking, classical music, audio equipment, and children's education—the latter at least partly inspired by his and his wife Ellen's determination to

provide the best possible learning environment for their own children, ten-year-old Meredith and seven-year-old Nathaniel.

Unlike many technology writers, Cary did not worship technology; to him, computers were merely a tool, not an end in themselves. He maintained that books would always be the best archival medium because, long after any given computer operating system had been abandoned, they would still be readable by anyone. And while everyone around him was embracing the Internet with its vast storehouses of information, Cary stubbornly maintained his position that little of importance was to be found there; he had only recently admitted that perhaps it was beginning to become somewhat useful.

**Professional Demeanor** A consummate professional who treated everyone—regardless of their status—with courtesy and respect, Cary never shirked his responsibilities and always came through when we needed him. Just before going to the hospital for the last time, he called in final changes to his review of the *PowerBook 2400c* for our November 1997 issue because he knew I was waiting for them.

But as impressive as Cary's intellect and achievements were, they alone could not have evoked such an outpouring of emotion from so many people. A Web site ([www.tidbits.com/caryl/](http://www.tidbits.com/caryl/)) containing reminiscences from a wide range of friends, colleagues, and those who knew him only through his writings shows what a profound influence he had on those whose lives he touched.

Many of those same people shared their feelings at a memorial gathering October 18 at Seattle's Museum of History and Industry, where Cary had last May previewed his forthcoming book, *The Race for Bandwidth* (Microsoft Press).

As he did with everything else, Cary faced his illness with courage, dignity, and wry humor. Ultimately, he will be remembered—and missed—as much for his generosity, candor, humility, and concern for others as for his technological prowess. ■



You were born  
**CREATIVE,**  
*not patient.*

©1997 Adaptec, Inc. All rights reserved. Adaptec, the Adaptec logo and tagline, PowerDomain, and Remus software are trademarks of Adaptec, Inc. and may be registered in some jurisdictions.  
†FireWire is a trademark of Apple Computer, Inc. and is used under license. \*All other trademarks belong to their respective owners.



Upgrade to Adaptec  
PowerDomain Plus with Wide  
UltraSCSI and desktop RAID.

Cut the time it takes to open, manipulate, and save Photoshop® files by a third. Yes, a *third*. All you need is Adaptec® PowerDomain™ Plus—a Wide UltraSCSI card capable of pumping 40MB/sec through Photoshop. It comes with our Remus™ desktop RAID software that totally cranks stuff across your hard drives. Adaptec also offers products that help you get digital video into your Mac from your DV camcorder like our 1394 FireWire† adapter. Or burn concepts onto CD with our Toast CD-recording software. Spend less time waiting and more time creating with Adaptec. **For details, call 1-800-804-8886 x7767 or visit: [www.adaptec.com/macworld](http://www.adaptec.com/macworld)**



# New Products

THE LATEST MACINTOSH RELEASES

Edited by Keith Mitchell

## DISPLAY

### Multiplying Monitors

If you need high resolution but don't have the desk space for a 21-inch display, Sony (408/432-1600, [www.sony.com/pc](http://www.sony.com/pc)) and ViewSonic (909/869-7976, [www.viewsonic.com](http://www.viewsonic.com)) have monitors for you.

- Sony's CPD-120VS Multiscan Multimedia Display is a 15-inch monitor with a 13.9-inch-diagonal viewable area. The \$529 display system has built-in speakers with a subwoofer and supports resolutions up to 1,280 by 1,024 pixels.

- ViewSonic's P775 17-inch monitor, priced at \$799, has a 16-inch-diagonal viewable area and a maximum resolution of 1,600 by 1,280 pixels. The G773, another 17-inch display system, supports resolutions up to 1,280 by 1,024 pixels and costs \$699.

### The Writing on the Wall

Projector manufacturers are pushing the technology envelope with new lower-priced products.

- The 14-pound DP9200 projector, from Proxima (619/457-5500, [www.proxima.com](http://www.proxima.com)), offers 1,024-by-768-pixel resolution at 500 lumens. The \$11,999 projector includes a 1.6:1 motorized zoom lens and computer and video inputs. The \$7,999 DP5800 provides 800-by-600-pixel resolution at 650 lumens. It weighs 19 pounds.

- The Polaview 315, from Polaroid (716/256-4436, [www.polaroid.com](http://www.polaroid.com)), projects up to 1,280 by 1,024 pixels at 600 lumens. It has a PC Card reader that enables presenters to put their data on a PC Card for computer-free use. Also included are zoom and picture-in-picture

capabilities. The projector weighs 21.5 pounds and costs \$11,995.

## GRAPHICS

### Thumbnail Views

You've got lots of images stored on a variety of media. How do you find the one that's right for your latest project? ImageBook 2.0, from Gamut Imaging (714/779-2421, [www.gamutimaging.com](http://www.gamutimaging.com)), scans your disks for images, automatically generating custom proof sheets and thumbnails. You can annotate the images and specify dimensions for images and proof sheets. The \$100 program supports more than 40 image file formats. An enhanced version, ImageBook 2.0 Pro, priced at \$250, supports Kodak's Photo CD discs and includes watermarking notification.

## MULTIMEDIA

### Lights, Action, Camera

DigiEffects' (415/841-9901, [www.digieffects.com](http://www.digieffects.com)) \$695 CineLook Broadcast plug-in for Adobe After Effects adds grain to the red, green, and blue video channels to achieve a match between video and film footage. The software uses its own frame-blending process to soften the video frames. Editors can use the standard After Effects plug-in interface or a customized interface that emulates stand-alone video-editing hardware.



DigiEffects CineLook

## ONLINE

### Video When?

A new streaming content-creation tool, VivoActive VideoNow 2.0, from Vivo Software (617/899-8900, [www.vivo.com](http://www.vivo.com)), is a simplified version of the company's VivoActive Producer. Intended for Web sites with moderate traffic, the \$119 software provides the core features of VivoActive Producer, including voice and FM-quality audio, predefined settings of streaming parameters, and a simplified user interface.

### Searching High and Low

WebFind Assistant 1.0.1, from Crush! Software (718/263-0313, [www.crushware.com](http://www.crushware.com)), gives desktop access to popular search engines. The Mac-only program appears as a floating palette on the Mac desktop. You enter a keyword or phrase, choose one of seven search engines from a pull-down menu, and click on the Search button. The software then launches versions 2.0 or later of Netscape Navigator and Microsoft Internet Explorer and displays the results. A single-user license is \$20.

### X Marks the Spot

Boutell.Com (206/325-3009, [www.boutell.com](http://www.boutell.com)) has released a Mac version of its image-map-editing tool, Mapedit. The \$25 software lets you add clickable hot spots to your Web images without using a separate image-map file. Mapedit 2.3 saves the hot spots directly into the HTML code. It requires Apple's Macintosh Runtime for Java 1.5.

## PRINTING

### Pablo's Printer

With CD recorders more popular than ever, recording artists and multimedia developers need their discs to look good. The \$1,199 Picasso CD Color Printer, from Mediastore (714/974-5551, [www.mediastore.com](http://www.mediastore.com)), uses thermal ink-jet technology to print 24-bit, 300-dpi images on CD-R media. It can print one CD label in about two minutes.



Picasso CD Color Printer

## PRODUCTIVITY

### Beyond Charts

Tired of making presentations with the same old static chart? Spice things up with Adrenaline Charts SE 1.0, from Adrenaline Software (418/658-9909, [www.adrenaline.ca](http://www.adrenaline.ca)). The \$60 program enables you to integrate pictures, textures, QuickTime movies, and QuickDraw 3D objects into multimedia charts. The charts can be exported as PICT files, JPEG images, or QuickTime movies for use within presentation programs. Data can be imported from Microsoft Excel and ClarisWorks.

## SYSTEMS

### Don't Let a PC Stop You

Are you stuck working on a PC because of your job? Check out Gemulator 98 Advanced Edition, from Emulators (206/236-0540, [www.emulators.com](http://www.emulators.com)). It's a \$200 Windows package that lets a PC emulate a 68040 (or earlier) Mac. It includes a half-size ISA card that holds Mac ROM chips, for speedier emulation. You can use any version of the Mac operating system, including Mac OS 8, but the product can't run PowerPC-native applications.

VENDORS: TO HAVE YOUR PRODUCTS CONSIDERED FOR PUBLICATION IN *NEW PRODUCTS*, SEND A PRESS RELEASE WITH PRODUCT DESCRIPTION, PRICE, AVAILABILITY, AND CONTACT INFORMATION FOR READERS, PLUS OPTIONAL PHOTO OR SCREEN SHOT, TO NEW PRODUCTS EDITOR, *MACWORLD*, 501 SECOND ST., SAN FRANCISCO, CA 94107; [NEW\\_PRODUCTS@MACWORLD.COM](mailto:NEW_PRODUCTS@MACWORLD.COM).



# Set Your World in Motion

New Bryce 3D lets you create incredibly realistic, fully animated 3D worlds. Where rivers rush through gorges, the sun sets over the ocean, or mist evaporates to reveal flocks of birds soaring between mountain peaks. It's just like the real world—only you're in control!

**Real-world atmospheric effects.** Set every part of your 3D world in motion, including atmospheric effects like clouds, the phases and positions of heavenly bodies, star fields, and fog and haze that react realistically to light intensity and color.

**Complete animation control.** Easily scale, resize, or position object paths in seconds, then link them to create motion. Set camera and lights to track specific objects automatically.

**Unbelievably realistic terrains.** Paint height values for peaks, valleys, plateaus, and erosion, then animate the entire scene to show the forces of nature in action. For instant results, check out the real-time, rotating 3D preview.

**Fully animatable materials and textures.** Picture brick transforming into flowing water. Or a snow capped mountain emerging from winter into spring. Now you can make it happen!





Get Bryce 3D and set your  
world in motion, the easy way!

**Macworld**  
BEST of SHOW  
1997 BOSTON EXPO



# BRYCE 3D IT MOVES

Attention Bryce Owners!  
Upgrade Today for Only \$99

**800.846.0111**

Dept. 125

[www.metacreations.com](http://www.metacreations.com)



**MetaCreations**

The Visual Computing Software Company

© 1997 MetaCreations Corp. All rights reserved. Bryce is a registered trademark of MetaCreations Corp. Scene rendered entirely in Bryce 3D.



Experience a day in the life of a prism.

*Because You Can.*





Sony's new 19" and 21" CRT technology is 40-50% flatter than traditional aperture grille and FST CRTs. \*\*Up to 35% improvement in beam shape accuracy over last year's model. †Requires Microsoft Windows 2.0 (included) — HDA adapter for computer required. SCITA04

Right out of the box, the Sony VAIO Tower (shown with VAIO 220VS Display) has all the software and processing power needed to explore digital imaging, video editing and website publishing.



Wirelessly beam your favorite photos from Sony's DSC-F1 Digital Still Camera straight to your PC\*, then show them off to your family and friends using your Sony display.

Capture your vision in vivid detail with the DCR-VX1000 Handycam® Camcorder and edit it with amazing precision and clarity on your Sony display.



Improve your world view with the new vertically-flat

Sony GDM-400PS 19" Trinitron® Display,

featuring an 18" viewable image, plus Active Signal Correction (ASC™) circuitry, which automatically sizes and centers your image at the touch of a button.



Sony VAIO™ Notebook and Docking Station combine to give you a full multimedia experience, plus seamless connections to your Trinitron display, VAIO All-in-One Printer and more.



For more info: 1-888-552-7669 or [www.sony.com/imagination](http://www.sony.com/imagination)

There is a place where ideas bask in sheer beauty, intense color and amazing clarity. But until this moment, it was only in your mind. Introducing the Sony GDM-400PS, one of 14 displays designed to bring your imagination yet another step closer to reality.

**VAIO** In addition to Sony's renowned Trinitron technology, the GDM-400PS also features a new flatter (over 40%\*) CRT design for more accurate images, not to mention less glare. Plus Sony's new Elliptical Correction System improves image accuracy up to 35%.\*\* And finally, like all of our displays, the GDM-400PS is fully compatible with your

PC or Mac®. Just open the box to all the possibilities. And your mind is sure to follow.

**SONY**



# Reviews

## Quicken Deluxe 98

NEW VERSION ADDS  
EVEN MORE GOODIES TO A  
POPULAR PRODUCT

**Q**UICKEN, INTUIT'S LEGENDARY financial manager, was once a simple but rich and rewarding product—kind of like a bowl of really good vanilla ice cream. Over the years, Quicken upgrades have added basic sundae toppings, in the form of financial-planning tools, QuickTime movies, interactive help, and more. With Quicken Deluxe 98, Intuit adds the financial equivalent of nuts, sprinkles, and M&Ms: No one will have trouble living without built-in Internet access to mortgage and insurance information, an emergency records organizer, investment help, or a tax-deduction finder, but many people will benefit from them. Intuit has also enhanced the basic program's appeal with subtle but satisfying changes to the registers, reports, and reconciliation features.

### Plain-Vanilla Pluses

Registers—Quicken's detailed check-booklike account lists—sport a new Shortcuts button that lets you schedule or move transactions via a pop-up menu; the same menu lets you quickly create reports on a transaction's payee or category. In addition to showing transactions with multiple categories or memos, the Splits window now automatically changes size to display more items. The Registers' nicest new feature, though, is the

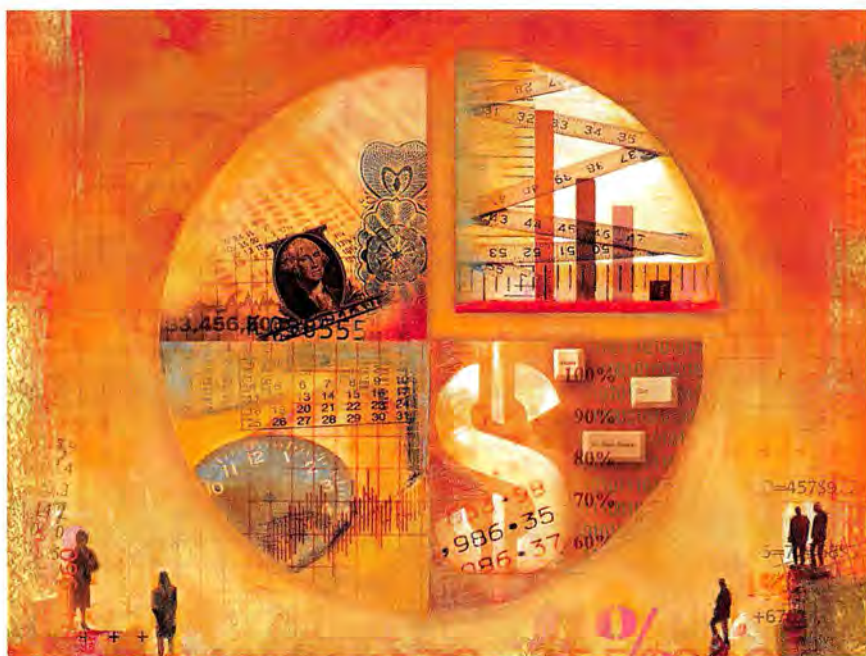

account bar, which appears at the bottom of the screen and lets you quickly switch among accounts. (Unfortunately, only the five most recently opened accounts appear in the bar, and you can't set it to always include your favorite accounts.) A new Total line at the bottom of the account list allows you to view your net worth without having to create a report or graph.

Quicken's reports have gained some wonderful features too. The Sample view generates an example of a report when you click on its name in the report list, to give you an indication of whether it's the report you're seeking. Some report styles have changed in this version; notably,

negative items now appear in red. Oddly enough, this alteration means that if you've overspent your budget, the difference appears in black; if you still have money left to spend, the difference is shown in red—a difficult shift to grasp.

Much more significant are Quicken's new icons and pop-up menus that let you edit your report's fonts, dates, headers, titles, and other elements from within the report itself. This editing ability alone makes the upgrade to Quicken 98 worthwhile for anyone who regularly uses reporting features.

If you've ever struggled to decipher the Reconcile window, you'll appreciate

**REAL PRODUCTS**  
**REAL RATINGS**

Reviews you can trust: Unlike other publications, Macworld rates only final shipping products, not prototypes. What we review is what you can actually buy.  
Outstanding ★★★★★=9.0-10.0 Very Good ★★★★=7.0-8.9 Good ★★★=5.0-6.9 Flawed ★★=3.0-4.9 Unacceptable ★=0-2.9



the instructions displayed within the window itself; a check box lets you hide the instructions if you don't need them (see "Green Is Good"). The Status window shows your balance and cleared items, as well as the difference between the bank's balance and your own (highlighting what remains), and cleared items now appear in green. The New Transactions button lets you quickly add transactions you've forgotten, and the Smart Reconcile feature tracks previous reconciliations, making it easier to review your past records and uncover any problems.

Quicken's internal online banking features have been improved as well. By signing up for Intuit Online Payment (\$9.95 per month, administered by the same group that handles the popular CheckFree service), you can make online payments from any U.S. checking account or any other domestic account that lets you write drafts or checks. The Payment Log shows all your activities for a 60-day period and lets you edit or cancel transactions or retrieve information about the status of your payments.

You can also apply for online banking services from a long list of financial institutions that work with Intuit. Unfortunately, the Web-based sign-up process proved confusing and difficult: I'd recommend getting the information you need from your bank before attempting anything within Quicken. If you already use online banking, you'll be pleased to discover the revised Download Transactions screen, which includes downloaded data and the account register in one screen. At last you can make edits without switching windows!

### Chocolate or Multicolored Sprinkles?

A pleasant addition to Quicken 98's Deluxe version is QuickEntry, a fast, simple utility that lets you enter transactions into registers without opening the Quicken application. It's small enough that you could keep it open permanently, but since it doesn't have a close box—you're stuck with a window permanently open on your screen—you may not want to. The next time you open Quicken, your transactions are added to your data file.

The new Emergency Records Organizer follows the step-by-step model of Quicken Deluxe's earlier Net Worth and Retirement planners. It's not particularly elegant, but it does let you store information about all your important records,

from birth certificates to investment documents, in one central location. The Organizer includes a valuable password-protection feature that protects you from having your Social Security, credit-card, or bank-account numbers fall into the wrong hands in case of burglary or unauthorized use of your Mac.

Following the same planner model, the Tax Deduction Finder leads you step-by-step on a search for qualifying ex-



**Green Is Good** In Quicken 98's new Reconcile window, cleared items are displayed in green, making it easy to see which transactions you've reconciled and which you haven't.

penses. This process has great potential, but despite the complexity of my own taxes, it was a waste of time—I didn't find a single item I'd missed. Maybe next year.

Overall, not much has been changed in Quicken's investment module, but a new graph option lets you display multiple investments on a single chart. Unfortunately, the graph couldn't compensate for a stock split (despite a check box that *should* have enabled this capability) and occasionally had trouble displaying all of my chosen securities, even when they appeared properly in the key.

### Online Additions

Intuit has added links within Quicken to Web sites featuring insurance, investment, mortgage, and financial-planning information. These sites are interesting and provide some valuable data, but it's important to note that you don't need Quicken to use them.

To set up Quicken for Web access, you could follow the step-by-step Apple Guide instructions via the Getting Started With Online Banking command, but my advice is to avoid them. During several attempts to use the directions, I found them highly erratic, with random red lines or circles appearing in odd places and steps being skipped entirely. Luckily,

it's easy enough to set up Web access without the directions. Just choose Preferences from the Edit menu, click on the Internet icon, select a connection method—AOL, CompuServe, or ISP—and then choose a Web browser.

With Web access enabled, you can check out all sorts of financial-planning information as quickly as your modem allows. The InsureMarket site lets you see quotes on life insurance from top companies (the company plans to add quotes for auto and homeowners' insurance this fall and winter, respectively), and the NetWorth site offers stock news, price charts, and dynamic graphing for investors. There's also an online tax center with tips and suggestions and a mortgage center that provides rate comparisons from leading lenders. Like most other Web sites, these sites are all regularly updated and upgraded. I occasionally encountered broken links and "file not found" errors, but the

dynamic aspect of the Web means that you may also discover new and interesting information to improve your financial life on an ongoing basis.

### Macworld's Buying Advice

Like many other Quicken users, I was perfectly satisfied with the bowl of plain-vanilla ice cream I had years ago in Quicken 4. Over the years, I haven't always been enchanted with the trade-offs each new version has brought, but overall—despite some fit-and-finish problems—I'm pleased with Quicken 98. The new report features found in both Quicken Basic 98 and Quicken Deluxe 98 are wonderful, while QuickEntry (found only in the Deluxe version) is quite handy. I can take or leave most of the other new features—specifically the Web links and the Emergency Records Organizer. Like M&Ms on a sundae, they're nice to have but far from essential.—WENDY SHARP

**RATING:** ★★ ★/6.9 **PROS:** Flexible report features; fast, handy QuickEntry utility in Deluxe version. **CONS:** Minor bugs; Internet features aren't Quicken-specific. **COMPANY:** Intuit (415/944-6000, www.intuit.com). **LIST PRICE:** Deluxe version, \$59.95; Basic version, \$39.95.



# Maxpowr Pro Series

POWERPC 750 CARDS MAKE GOOD ON TSUNAMI ARCHITECTURE'S UPGRADE PROMISE

**T**HE CLONES ARE DEAD, AND I miss them already. Power Computing, Umax, and others had a terrific habit of releasing new technology earlier than Apple and selling their wares at competitive prices. Motorola was poised to ship its StarMax Pro 6000/300, the first computer based on the lightning-fast PowerPC 750 CPU (code-named G3), as Mac OS licensing was halted. Three weeks later, after the termination of the StarMax 6000 and other G3 clones, Apple announced plans for its own midrange PowerPC 750 machines, all with processor and cache bus speeds slower than those of the planned StarMax Pro.

Newer Technology's Maxpowr Pro processor cards reputedly work with any upgradable Power Mac (except Power Computing's Catalyst-based PowerCenter series): Apple's 7300, 7500, 7600, 8500, 8600, 9500, and 9600; Power Computing's PowerWave and PowerTower Pro series; and Umax's SuperMac J700 and S900 series. You take the old processor out, put the Maxpowr Pro in, press the logic-board reset button, and you're in business. I tested a Maxpowr Pro+ in my SuperMac S900/200 and had everything up and running without incident in a matter of minutes. Macworld Lab tested the cards in a sampling of machines from Apple and Power Computing. The Lab couldn't get the Maxpowr Pro to work with a Power Mac 7300 with the card set to its highest speed (50MHz), but

otherwise the Maxpowr Pro proved compatible across the board.

The two models in the Maxpowr Pro series sport slightly different clock speeds and radically divergent prices. The 250MHz Maxpowr Pro lists for \$1,395 (about \$1,250 street), whereas the 266MHz Maxpowr Pro+ costs a whopping \$2,499 (about \$2,200 in stores). The reason for the \$1,100 discrepancy has little to do with the minor 16MHz difference in clock speed and almost everything to do with the size and speed of each card's cache.

## Backside Boost

In most 604e-based Macs, data travels between the cache and the CPU over the system bus, which tops out at 50MHz. The Maxpowr Pro cards are the first to employ backside cache, in which the cache resides directly on the processor card and links to the CPU chip via an independent bus. The less expensive Maxpowr Pro has a 512K cache that communicates with the CPU at 125MHz, half the CPU's clock speed. The high-end Maxpowr Pro+ includes 1MB of cache with a backside bus speed of 177MHz, 67 percent of the CPU's clock speed.

In Macworld Lab's SpeedMark tests, the 250MHz Maxpowr Pro boosted the overall speed of an aging Power Mac 7500 by more than 200 percent, a speed surpassed only by that of the new Power Mac 9600/300. With the 266MHz Maxpowr Pro+ installed, the 7500 beat even the

9600/300, being 6 percent faster in the SpeedMark CPU tests and 9 percent faster in the FPU tests. Both cards would have performed even better if we had outfitted the 7500 with a new hard drive and video card, but the older hardware is more in keeping with the experiences of typical users. Most upgradable Power Macs will benefit dramatically from having either of Newer's Maxpowr Pro cards.

## Macworld's Buying Advice

I was amazed by the increase in the speed of my SuperMac S900. The machine started up about 50 percent faster, I didn't have time for my usual coffee break while launching Microsoft Word, and I was able to play a 320-by-240-pixel QuickTime movie at the full 30 frames per second without special acceleration hardware. The only drawback is the price—particularly that of the Maxpowr Pro+, which costs more than Apple's 266MHz G3 system (see "Apple's Next-Generation Systems," in this issue). Luckily, forthcoming PowerPC 750 cards from PowerLogix and Total Impact should provide a more competitive atmosphere and lower prices all around.—DEKE MCCLELLAND

## Maxpowr Pro Series

MAXPOWR PRO 250/125 ★★★★★/7.1

MAXPOWR PRO+ 266/177 ★★★★★/7.2

**PROS:** Virtually doubles the speed of Power Macs that have upgradable CPUs. **CONS:** Price of Maxpowr Pro+ equivalent to that of a new computer.

**COMPANY:** Newer Technology (316/943-0222, www.newertech.com). **LIST PRICE:** Maxpowr Pro, \$1,395; Maxpowr Pro+, \$2,499.



## Maxpowr Pro Series: Cache Boosts Performance

Longer bars are better. An Apple Power Macintosh 7100/80 has a SpeedMark score of 1.0. ▶ New product.

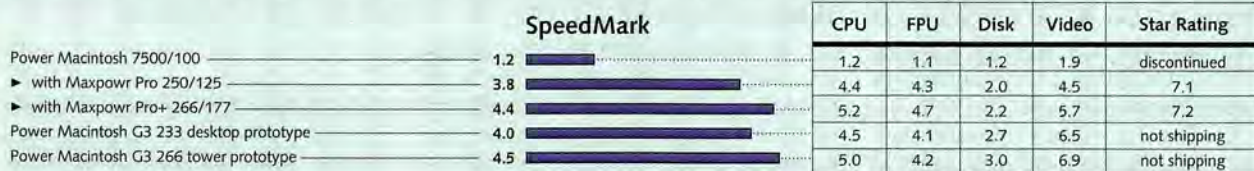

### Behind Our Tests

All PowerPC 750 products, except the Maxpowr Pro+ 266/177 (which has 1MB of cache), have 512K of cache. For detailed information on our methodology, refer to [www.macworld.com/tests/](http://www.macworld.com/tests/).—Macworld Lab testing supervised by Jeffy Milstead



# ClarisWorks Office

INTEGRATED PACKAGE IS STILL A SUITE DEAL

**O**FFICE SUITES TYPICALLY include industrial-strength programs, any one of which is a top contender in its field. In the Windows realm, Microsoft Office, Lotus SmartSuite, and Corel WordPerfect Suite, contain Excel 97, Lotus 1-2-3 97, and Quattro Pro 8, respectively—all top-quality spreadsheet programs.

Viewed in that light, ClarisWorks Office is more marketing spin than powerhouse collection. Built around the minimally revised ClarisWorks 5.0, ClarisWorks Office offers a great value—especially if you don't already have an existing set of software and need an all-in-one productivity package—but owners of ClarisWorks 4.0 shouldn't rush to upgrade.

## Small Changes, Big Value

The core of ClarisWorks Office is ClarisWorks 5.0, and once again, Claris has chosen to refine the program's features rather than indulge in wholesale change. This incremental approach ultimately proves successful; ClarisWorks 5.0 is easier to use than its predecessors, thanks to a fully customizable button bar that replaces the old Shortcuts floating palette and allows you easy access to virtually all of ClarisWorks' features. You can create new buttons, move or delete predefined buttons, and switch among button bars. A pop-up menu switches you to the Internet button bar, and a single click launches your preferred mail program.

Alas, Claris has once again missed the opportunity to integrate its different products tightly. If you're willing to invest a bit of time in scripting, though, ClarisWorks' buttons can store macros or trigger AppleScripts, to provide a wide range of integration possibilities. I can easily imagine addressing a letter by typing my correspondent's name and then pressing a hot key that would look up the person's mailing address from Claris Organizer and insert the address automatically. Unfortunately, that just isn't possible unless you write a script yourself.

## Web Works

But ClarisWorks 5.0 *does* integrate well with the Internet. Within any word-

processing document, spreadsheet, or drawing, you can create hyperlinks (called bookmarks) that connect to other places within the same document, to other ClarisWorks documents, or to Web pages via embedded URLs. Clicking on a Web link launches your preferred browser, connects your Mac to the Internet, and loads the specified page.

You can also create simple Web pages within ClarisWorks' word processor, thanks to a much improved HTML-conversion translator. The included

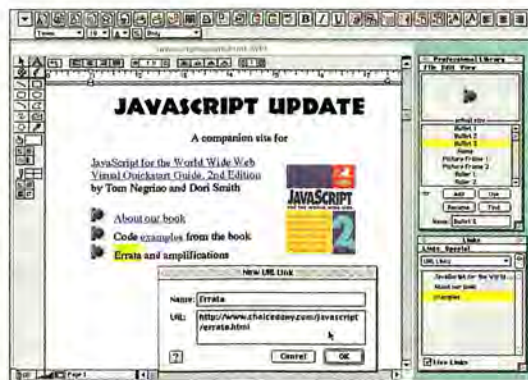

**Making Connections** ClarisWorks' new hyperlink feature lets you create URL and document links from the Links palette, and Web pages you create can then be exported as HTML. The expanded clip-art libraries provide graphics pizzazz.

Claris Home Page Lite lets you create more-ambitious Web pages but lacks the full version's support for direct HTML editing, frames, and forms, among other features. Two Internet service providers' packages on the CD-ROM include Web-browser software and a program that helps you get signed up to the service and onto the Internet quickly.

## More Modest Enhancements

Other ClarisWorks changes are relatively minor. The word processor's text ruler has been reorganized, with helpful page guides that appear when you move margins or tabs. A new equation editor aids science- and math-oriented users, and the Function button on the spreadsheet's status bar makes it easier to insert math functions. You can—at long last—name cells and ranges, and rows and columns can now autosize to their contents.

Within the database module, the new Multimedia field type lets you store pictures, sounds, or QuickTime movies, and database fields can hold up to 1K of text—double the previous limit. The new Texture palette offers 120 options and works with the painting module's spray can, bucket, and brush tools and with the fill tools within the draw module.

Novices and professionals alike will appreciate the vast quantity of stationery documents bundled with ClarisWorks Office. The JIAN Business Basics collection includes 64 useful word-processing and spreadsheet templates for common business operations. In addition to more than 20 accounting spreadsheets, management templates include, for example, articles of incorporation, public-relations documents, and worksheets for trade-show planning. Claris has also added more than 200 other stationery layouts for home, business, and school users. New clip-art libraries include more than 1,000 images that can be used for slide shows, drawings, and Web pages.

## Macworld's Buying Advice

ClarisWorks Office preserves the true strengths of the original ClarisWorks: It requires a mere 2.5MB of RAM and still works on any Mac with a 68020 processor or better. Speed complaints are rare with

ClarisWorks, and the various modules work exceptionally well together. Although the ClarisWorks Office components lack the depth of features available in their Microsoft Office counterparts, they're more than sufficient for home, school, and small-business users—at a cost savings of hundreds of dollars. ClarisWorks 4.0 users probably won't find any pressing need to upgrade, but if you're buying your very first Mac, ClarisWorks Office provides all the software you'll need to get started.—TOM NEGRINO

**RATING:** ★★★★★/8.3 **PROS:** Good stationery and clip art; welcome, though minor, improvements to ClarisWorks. **CONS:** Less office than you might expect. **COMPANY:** Claris (408/727-8227, www.claris.com). **LIST PRICE:** \$99; \$30 rebate for upgrades.



# Personal Information Managers

LOTUS ORGANIZER 97 GS, ACT 2.8 ADD LITTLE TO THE GENRE

**L**OTUS ORGANIZER IS THE LATEST entry into the crowded personal-information-manager (PIM) market, while Symantec's Act has been around for years. But although they approach their duties from two radically different directions, neither product brings much to the table that existing PIMs don't already offer.

## Contact Central

Offering more than 70 customizable fields, Act 2.8 handles any kind of contact information you can throw at it. Pick lists—pop-up lists of predefined entries—cut down on typing, but an auto-completion feature would work better. Based on the assumption that you'll always want to associate activities with a particular person, Act has you schedule events by clicking on fields in the contact window.

Organizer's methods are less contact-centric; you shuttle among seven individual sections by clicking on tabs. Organizer's address-book module isn't as comprehensive as Act's, but it's probably sufficient for most people's needs. Data-entry shortcuts are limited, however.

Both PIMs let you track interactions with clients, although Act—with its ability to automatically record and display all events associated with a given contact—proves much more comprehensive. Organizer lets you schedule and record details about phone calls, but there's no way to associate a to-do or anniversary item with a particular person.

## Time Control

Managing schedules and to-do lists never has been Act's strong suit, although the latest release incorporates several enhancements, including the ability to display more event information in calendar windows. Unfortunately, some annoying limitations still haven't been remedied. Act's scheduling dialog box doesn't provide sufficient room for event descriptions, and there's no way to accommodate to-do items that aren't associated with a particular date.

Organizer's time-based functions are spread across five modules. Fortunately, you can create a new entry in any section

without leaving the module you're working in. Organizer also lets you display entries from other sections in your appointment book, so you don't have to switch to the anniversary module to find that you forgot your spouse's birthday.

You can book several events in succession without leaving Organizer's dialog box, and you can "pencil in" tentative appointments (see "Flexible Events"). And although Organizer lets you set alarms for timed events, you have to enter the date and time for the alarm if you want to be notified more than one day in

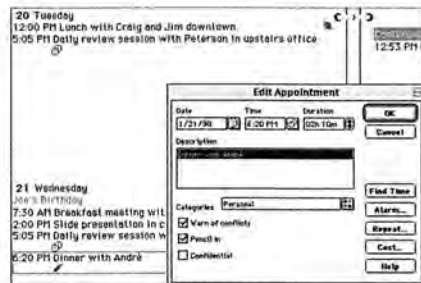

**Flexible Events** Tentative events appear with a pencil symbol in Organizer's day and week views.

advance. Worse yet, Organizer must be running for you to receive reminders, unlike Act, which uses a separate background application to activate alarms.

## Ins and Outs

Over the years, Act has shed its Windows origins and become more like a Mac application, with fewer modal dialog boxes and more resizable windows (see *Reviews*, July 1996), but its interface is still a bit drab for my taste. On the other hand, Organizer commits GUI overkill, serving up a confusing jumble of tools that makes it hard to pick the appropriate icon; I found it much easier to use Organizer's logically arranged menus.

Both PIMs provide multiple ways to print schedules and contact information, with layouts for several popular paper-based planners. Act even sports an integrated word processor that's more than capable of handling letters and other simple documents. Organizer and Act also let you send e-mail to contacts, but Organizer works exclusively with Lotus Notes.

Act lets you use other e-mail clients.

Both programs let you share files over a network, and Organizer lets you perform group scheduling if you use Lotus Notes. Both Symantec and Lotus claim compatibility with their Windows PIMs, but you can't share files with Act 3.0 for Windows. Either program lets you exchange data with other PIMs, but Organizer's import function is flawed: The program requires that every time be preceded by a date, so you may have to rearrange your data before importing it.

Act is twice as expensive as Organizer, but it uses far less memory—4MB versus 11MB—a significant difference if you want to keep your PIM running all the time. Organizer also suffers from a few bugs, ranging from cosmetic problems to occasional unexpected quitting.

## Macworld's Buying Advice

If your primary goal is contact management, Act is the better choice of these two products. Organizer is worth considering only if you are already using Lotus Notes and need to do group scheduling. Most users, though, are better off choosing Now's full-featured PIM duo, Up-to-Date and Contact 3.6.5 (see *Reviews*, June 1997). Priced below \$100, the pair costs less than Act and provides far more functionality.—FRANKLIN TESSLER

## Act 2.8

**RATING:** ★★ ★/5.6 **PROS:** Light memory requirement; strong contact manager. **CONS:** Limited scheduling functions; lackluster interface. **COMPANY:** Symantec (408/253-9600, www.symantec.com). **COMPANY'S ESTIMATED PRICE:** \$169.95.

## Lotus Organizer 97 GS

**RATING:** ★★ /4.0 **PROS:** Efficient event scheduling. **CONS:** Poor import functions; must be running to receive alarms; high memory requirement; works only with Lotus Notes for e-mail. **COMPANY:** Lotus Development (617/577-8500, www.lotus.com). **LIST PRICE:** \$85.



# Motion-Detection Software

PACKAGES OFFER DIVERSION, SECURITY, FRUSTRATION

**E**VER WONDER WHO'S MAKING off with your jelly beans while you're away from your desk? Or who's sneaking your office supplies without leaving a note? You can find out by using a motion-detection utility with your video-camera-equipped Mac. Two such utilities, Connectix's DigitalRadar 1.0 and Channel D's DeltaVideo 1.1, offer a range of tools for monitoring, recording, and responding to movement that occurs in front of your computer. DigitalRadar succeeds as a slickly executed amusement; DeltaVideo promises greater precision and analysis capabilities but falters in its implementation.

## Setting the Trap

Both packages are a snap to install; with either package, you're ready to begin video surveillance within minutes. Of the two, however, DigitalRadar is more polished and more fun to use. One of its windows displays the camera's field of vision, while the other displays a graphical activity log. You configure the program's various features using well-designed dialog boxes; the documentation is similarly clear and concise.

Unfortunately, DeltaVideo lacks a similar fit and finish. With its garish colors, cramped dialog boxes, window-redrawing gymnastics, and tunneling and blinking cursor, DeltaVideo's interface can cause confusion and headaches. To be fair, it's not a particularly difficult interface to navigate; it's just less pleasant than you would expect from a modern Macintosh application.

Both packages require a 68030 or better processor, System 7.1 or newer, QuickTime (version 2.1 for DeltaVideo and 2.5 for DigitalRadar), 10MB of disk space, and 4MB to 5MB of available RAM on Power Macs. They support standard video sources, including Connectix QuickCams. I tested each with a Color QuickCam connected to a Umax SuperMac S900/233 and a range of older Power Macs.

## Secret Weapons

DigitalRadar and DeltaVideo offer different takes on motion-detection video. DigitalRadar defaults to recording mo-

tion in a movie format, starting when motion is detected and concluding when motion stops. You can also configure it to take single snapshots. Thumbnails of snapshots and movie clips appear in the log window with corresponding date and time information, and you can view the full-size picture or play the QuickTime movie by double-clicking on its log entry. Unfortunately, there's no way to stamp the time and date directly onto the snapshots or QuickTime videos, nor any way of indicating which location triggered the motion detector.

DigitalRadar provides an option for rendering log files invisible and locked in the Finder, and you can password-protect the logs. If you want to let your prey know they're being watched, you can configure DigitalRadar to play a sound whenever it detects motion (a variety of warning and alarm sounds are included); alternatively, the program can respond by launching a designated application or AppleScript. Date- and time-scheduling options allow you to set up DigitalRadar and have it perform its motion-detection duties without additional intervention.

DeltaVideo defaults to capturing snapshot images when it detects movement, and it allows QuickTime recording only for a fixed period after activation (for example, you can set it to record five seconds of video after a detected movement). Captured images are displayed in an on-screen contact sheet; you have to open QuickTime movies from the Finder. Although DeltaVideo can pass Apple events to other applications when it detects movement, it doesn't offer a built-in alarm or greeting feature. Overall, DeltaVideo is less suited to casual users looking to have a little spying fun.

DeltaVideo does, however, pack some advanced features that make it compelling for more-sophisticated uses. You can limit motion detection to a rectangular area within the camera's field of vision; the application automatically notes the coordinates where motion was detected and can label its snapshots with time, date, numeric coordinates, and a large pointer indicating the area of the picture that triggered the capture. You can tell Delta-

Video to capture snapshots when motion is detected, at regularly timed intervals, or using some combination of the two. DeltaVideo can save log files as a QuickTime movie, creating a time-lapse animation; as a contact sheet; or as a text file—useful for analysis and charting within your favorite spreadsheet application.

But DeltaVideo has several bugs that seriously degrade the user experience. During testing, the program crashed repeatedly when I tried to use its limited-area motion-detection and QuickTime-capture features. I also encountered a



**Busted!** Connectix's DigitalRadar monitors your workspace and captures the action to disk.

variety of less repeatable crashes. Channel D has posted a revision that fixes the most egregious bug, and I was able to work around several of the others.

## Macworld's Buying Advice

Although neither of these packages is likely to appeal to serious security experts, each has its virtues. Users looking to add a little fun and function to their Macs will adore DigitalRadar; those with motion-tracking and -analysis needs will find DeltaVideo attractive but its interface and stability problems off-putting.—J. W. DAVIS

### DeltaVideo 1.1

**RATING:** ★★/4.1 **PROS:** Detection-area specification; frame labeling; text export. **CONS:** Rough interface; occasional crashes; poor movie support. **COMPANY:** Channel D (732/933-9388, www.channld.com/sw.html). **LIST PRICE:** \$99.

### DigitalRadar 1.0

**RATING:** ★★★★★/8.2 **PROS:** Attractive interface; works exactly as advertised. **CONS:** Lacks labeling and text logging. **COMPANY:** Connectix (415/571-5100, www.connectix.com). **COMPANY'S ESTIMATED PRICE:** \$29.95.



# Video-Effects Software

COMMOTION AND ILLUMINAIRE PAINT SHOW PROMISE BUT NEED SOME REFINEMENT

**V**IDEO-EFFECTS MAVENS, TAKE notice: two new applications offer relief from repetitive, frame-by-frame tweaking. Discreet Logic's *Illuminaire Paint* 1.1, an object-oriented video-painting application, lets you control still images in video clips. Puffin Designs' *Commotion* 1.0.5 video-painting and -compositing application lets you work with multiple video clips. Both offer keyframing and other features for manipulating objects across time, along with Photoshop-like drawing tools and effects filters. But *Illuminaire Paint* supports a variety of painting and drawing options and third-party effects filters, while *Commotion* is more useful for adding special effects to a finished product and cleaning up images.

## Pretty Babies?

Of the two, only *Commotion* looks like a mature Mac application. Its interface is similar to Photoshop's, with windows that display information intuitively in collapsible menus. *Illuminaire Paint* sports more windows than *Commotion* but fewer tools. Its tool and radio buttons are shallow and have a stenciled look that makes them difficult to read.

But whereas *Commotion* lacks text capabilities, you can do most or all of your titling in *Illuminaire Paint*; *Illuminaire* supports Adobe Type 2 and PostScript fonts, although its text-tool options are woefully limited. Once the type has been rendered, however, manipulating it is easy. Each character appears as a separate object in the Timeline window, making it a breeze to fix typos and create multiple versions of a clip.

## Distinguishing Features

*Commotion*'s roto-splining function, its most useful feature, lets you create Bézier paths around objects over time (see "Along the Path"). By changing the shape of the paths frame by frame, you can create animated splines and play them back in real time. However, the most versatile tool in *Commotion*'s arsenal is its Super Clone brush, which allows you to toggle among up to four source

images and preview them against the target image before compositing.

*Illuminaire Paint*'s object-oriented approach gives you easy control over keyframing using the Timeline window, which lists all the clip's objects and their properties. By toggling the on/off control button next to objects along the length of a clip, you can let *Illuminaire Paint* interpolate their movement between the keyframes and save yourself hours of manual labor. Alas, *Illuminaire Paint*'s timeline is a mess; to view discrete objects in the Timeline window, for example, you're forced to pull it out so far as to obscure other palettes.

*Illuminaire* does support plug-ins for Adobe Premiere and AfterEffects and MetaTools' Final Effects, along with QuickTime, Photoshop, PICT, and Targa file formats. *Commotion* supports only QuickTime and PICT and doesn't support third-party plug-ins at all, but it has the same drawing tools and effects filters as *Illuminaire Paint* and adds others that let you avoid having to repair earlier, uncompiled versions of your video. Its wire-removal brush, for example, quickly erases wires and other fine lines. You can set the brush's options to either clone ("restore") pixels from neighboring frames or blend ("seam") adjacent pixels within the frame.

## Playback Time

Both applications promise real-time video playback, but only one delivers. *Illuminaire Paint*'s full-size playback is excruciatingly slow—the price of its comprehensive, object-oriented approach. It simply tries to play clips as fast as possible, which is never fast enough to be considered real-time; instead, you must track objects by reading their *x* and *y* coordinates.

*Commotion* offers a more manageable approach to real-time video playback. Its Load Frames dialog box offers a slider that lets you isolate the frames you need to work on; another slider lets you select a subset of the frames loaded into RAM for playback.

If you have a Power Mac with built-in video input or a video-editing card and

at least 156MB of RAM, you can easily get 30-fps playback of uncompressed, broadcast-quality video. And *Commotion*'s Auto Frame Spool option can load subsequent frames into RAM by caching the first frame to a scratch disk, although that slows playback considerably. *Illuminaire Paint* lets you specify any frame rate you like, but you're unlikely to see anything in the neighborhood of 30 fps.

Although the vendors of both products make substantial performance claims for their software on Macs with minimal available RAM and without video cards, neither *Illuminaire Paint* nor *Commotion*



**Along the Path** *Commotion*'s roto-splining function makes matting quick and easy.

makes sense for low-end systems. If you're unwilling to drop a couple hundred dollars on RAM, you'll find the cost of these two downright prohibitive.

## Macworld's Buying Advice

If you need to compile multiple clips in a hurry but don't want to give up basic filter effects, check out *Commotion*. *Illuminaire Paint* is too slow and unattractive at this point in its development, but the application does show some promise, particularly in its support for third-party plug-ins.—MARK BAARD

## Commotion 1.0.5

**RATING:** ★★ ★/5.7 **PROS:** Good design; real-time video playback, even with limited system resources. **CONS:** No support for plug-ins. **COMPANY:** Puffin Designs (415/331-4560, www.puffindesigns.com). **LIST PRICE:** \$2,495.

## Illuminaire Paint 1.1

**RATING:** ★ ★/4.5 **PROS:** Easy keyframing of discrete objects over time. **CONS:** Poor design; slow. **COMPANY:** Discreet Logic (310/618-9700, www.illuminaire.com). **LIST PRICE:** \$1,995.





*"Norm the Bee Guy" as printed on the EPSON Stylus Photo.*

# INTRODUCING THE FIRST PRINTER THAT'S AS RELENTLESS ABOUT CAPTURING A PHOTOGRAPH AS YOU ARE.



It's called the EPSON Stylus<sup>®</sup> Photo and its virtually continuous tone printing treats your photo with the respect it deserves. How? With Micro Piezo<sup>™</sup> ink jet technology—the cleanest, most consistent way to get 6 colors of ink on paper. The results? Incredibly smooth gradations, amazing detail and perfect color. Now, nothing will stop you from getting a great print of your photograph. After all, nothing stopped you from capturing it. Not even a swarm of hungry bees. For more information, call 1-800-GO-EPSON and ask for Operator 3010. Or visit [www.epson.com](http://www.epson.com).

**VIRTUALLY CONTINUOUS TONE 6 COLOR PRINTING / 720 X 720 DPI / FULL MAC & WINDOWS COMPATIBILITY / \$499\***

\*Street price may vary. EPSON and EPSON Stylus are registered trademarks of Seiko Epson Corp. Micro Piezo is a trademark of Epson America, Inc. ©1997 Epson America, Inc.

YOU'VE GOT TO SEE IT IN



COLOR.





# MP-EG1A

## MPEG CAMERA PERFORMS BETTER WITH WINDOWS

**H**ITACHI'S MP-EG1A HINTS THAT the days of separate still-photo and movie cameras are drawing to a close. It's a camcorder, a digital camera, and a voice-recording device all in one. And best of all, the MP-EG1A—which Hitachi has informally dubbed the MPEG Cam—records to a tiny 260MB hard disk instead of tape.

Current digital camcorders rely on Mini DV tapes that are as subject to the arbitrary scourges of munching and snapping as their common VHS cousins. The MPEG Cam wouldn't know a tape if it wrapped itself around the camera like a boa constrictor. Like some digital still cameras, it records to a pocket-size PC Card. But whereas a typical Type II PC Card holds 10MB to 20MB, Hitachi's 260MB Type III PC Card boasts a tiny, surprisingly durable hard drive. I inadvertently dropped the camera from a height of 3 feet onto my driveway without losing a single frame of stored data.

### Capacity and Framing

With a 260MB card, the MPEG Cam holds 20 minutes of moving MPEG footage, and you can purchase a 340MB PC Card that holds an additional 26 minutes for \$599. The camera shoots 352-by-240-pixel MPEG1 movies at a full 30 frames per second. Although the movies are NTSC-compatible—you can play them out to your television and even record the footage to VHS if you like—each frame is a separate snapshot. The digitized soundtrack is monaural.

You can also shoot 704-by-480-pixel still images. The bundled 260MB card can hold a whopping 3,000 stills—100 times as many as typical digital still cameras—and the optional 340MB card can hold up to 3,900 stills. It's unlikely you'll use the MPEG Cam strictly to shoot still images, but there's plenty of room on the card to rattle off a few snapshots along with your movies.

The MPEG Cam relies exclusively on an LCD screen for framing shots—it doesn't have an optical viewfinder. But unlike other digital-camera vendors, Hitachi bundles a fold-up hood for the LCD, so you can preview your shots

comfortably under the harshest light. Hitachi also throws in a remote control, a swivel stand, and two rechargeable batteries—each of which weathers several days of shooting.

### The MPEG Cam and the Mac

Hitachi obviously has PC users in mind as the primary market for the MPEG Cam. It comes with an ISA interface card and a wide assortment of Windows software that Mac folks can't use, and the camera



**Not a Toy** On a Mac, the QuickTime MPEG Extension scales an MP-EG1A movie to 320 by 240 pixels (A). Under Windows, the bundled decoder retains the full 352-pixel width but displays a dithered picture (B). Regardless of the platform, a still image measures 704 by 480 pixels (C).

started shipping several months before Hitachi unveiled its Macintosh SCSI Interface Kit (which costs an additional \$299.95). The kit includes QuickTime 2.5, QuickTime MPEG Extension 1.0.1, and Version 2.1.5 of the Thread Manager, all minimum requirements for playing MPEG Cam movies. If you own a PowerBook with a Type III PC Card slot, you don't need the SCSI Interface Kit but you'll have to download the new MPEG Extension.

As if it's not enough that you have to pay more for them, the Mac hardware and software are a pain to use. I was able to install the ISA card in about ten minutes. By comparison, the Mac version makes you set pins to change the SCSI address, and it must be at the end of the SCSI chain. The Mac transfer utility

is clunkier than the similar utility for Windows, and although Hitachi supplies an MPEG decompressor that retains the entire 352-pixel movie width for PCs, Apple's MPEG Extension compresses the frame horizontally to 320 pixels (see "Not a Toy").

### Macworld's Buying Advice

The MPEG Cam's still images compare well to those of digital cameras in the \$500-to-\$1,000 range, and—given that the MPEG Cam holds 100 times as many pictures—multimedia developers with large budgets should have little problem justifying spending close to \$2,700. I found the focus on the MPEG videos soft compared to that of their still counter-

parts and some people may balk at the relatively small frame size and 20-minute capacity, but all are symptoms of the state of MPEG technology, not a Hitachi design flaw. If you have any qualms about investing in this new technology, wait to see if something better comes along. Or wait for Hitachi to come up with a more acceptable Mac bundle.—DEKE McCLELLAND

**RATING:** ★★/6.4 **PROS:** Stores MPEG movies directly to removable hard disk; holds 20 minutes of video or 3,000 still images; includes LCD hood and rechargeable batteries. **CONS:** Mac connection kit costs extra and compares poorly to PC offering. **COMPANY:** Hitachi Home Electronics (770/279-5600, [www.mpegcam.net](http://www.mpegcam.net)). **LIST PRICE:** \$2,399.95; SCSI Interface Kit, \$299.95.



# What You Don't Know CAN Hurt You!

Order The Training You Need Now

Computer Training on  
Video & CD-ROM

# \$49

per volume

Call Toll Free  
800.527.1914



### Business & Presentation Software Training

- ClarisWorks 4.0  Video  CD-ROM 7 Volumes
- Excel 5.0  Video  CD-ROM 5 Volumes
- FileMaker Pro 3.0  Video  CD-ROM 5 Volumes
- Microsoft Works 4.0  Video 5 Volumes
- Persuasion 4.0  Video 2 Volumes
- PowerPoint 4.0  Video  CD-ROM 2 Volumes
- Quicken 7.0  Video  CD-ROM 2 Volumes
- Word 6.0  Video  CD-ROM 6 Volumes

### Graphics & Web Design Software Training

- FreeHand 7.0  Video  CD-ROM 6 Volumes
- FreeHand 5.5  Video 6 Volumes
- Illustrator 7.0  Video  CD-ROM 6 Volumes
- Illustrator 6.0  Video 6 Volumes
- PageMill 2.0  Video  CD-ROM 2 Volumes
- Photoshop 4.0  Video  CD-ROM 10 Volumes
- Photoshop 3.0  Video 10 Volumes

### Multimedia Software Training

- After Effects 3.1  Video  CD-ROM 4 Volumes
- Director 6.0  Video  CD-ROM 5 Volumes
- Director 5.0  Video 5 Volumes
- Premiere 4.2  Video 3 Volumes

### Desktop Publishing Software Training

- Design & Layout  Video 1 Volume
- Desktop To Prepress  Video 2 Volumes
- PageMaker 6.5  Video  CD-ROM 6 Volumes
- PageMaker 6.0  Video 7 Volumes
- QuarkXPress 3.3  Video 4 Volumes

### Specialty Software Training

- HyperStudio 3.1  Video 2 Volumes
- Mac OS 8  Video 4 Volumes
- Mac OS 7.5  Video  CD-ROM 4 Volumes
- MiniCad 6.0  Video 2 Volumes
- Networking  Video 1 Volume
- Norton Utilities  Video 1 Volume
- Troubleshooting  Video 3 Volumes

Please call for a free catalog of our complete line of Video & CD-ROM training products

*I recently purchased seven videos from MacAcademy. In a matter of just a few days, I was catapulted from an idiot to a genius. What a truly outstanding service it is you people provide. Thank you.*

—John W. Wilbanks  
Little Rock, Arkansas

## ORDER FORM

Please give us your daytime phone number in case we need to contact you concerning your order.

Phone ( ) \_\_\_\_\_ Fax ( ) \_\_\_\_\_

SHIP TO

BILL TO

If different from Ship To address

Name \_\_\_\_\_ Name \_\_\_\_\_

Company \_\_\_\_\_ Company \_\_\_\_\_

Address \_\_\_\_\_ Address \_\_\_\_\_

City \_\_\_\_\_ St \_\_\_\_\_ Zip \_\_\_\_\_ City \_\_\_\_\_ St \_\_\_\_\_ Zip \_\_\_\_\_

### PAYMENT

Check (payable to MacAcademy)  Purchase Order (must be attached)

VISA/MASTERCARD/AMERICAN EXPRESS/DISCOVER

Card # \_\_\_\_\_ Exp. Date \_\_\_\_\_

Signature \_\_\_\_\_

Product	Version	Volume	Video	CD-ROM	Unit Cost	Total

Please add \$5 per order plus \$1 per volume for shipping & handling. Outside the continental U.S. please call for shipping costs.

Florida residents please add sales tax for the county in which you reside (either 6%, 6.5%, or 7%)

**Please Call, Mail, or Fax Your Order to:**

MacAcademy Dept SP-1146  
100 East Granada Blvd Ormond Beach FL 32176-1712  
Phone 904.677.1918 Fax 904.677.6717

MacAcademy UK Phone 01953.457.600 MacAcademy Australia Phone 03.9705.1066

Product Total	
Shipping & Handling	
Subtotal	
Florida Resident Tax	
Total	

# MacAcademy

Committed To Excellence

<http://www.macacademy.com>

©1997 FMI

Circle 106 on reader service card





# Cubasis AV

INEXPENSIVE AUDIO AND MIDI RECORDING

**T**HE INTERSECTION OF DIGITAL audio and MIDI recording is one of the hot spots on the music scene. It's a best-of-both-worlds place where the software can record and play back not only audio, such as vocals and acoustic instruments, but also the MIDI note data that synthesizers send and receive. It's a hard neighborhood to get into, though: The top MIDI sequencer/audio-recording programs, Opcode's Vision and Studio Vision series and Mark of the Unicorn's Digital Performer, are complex beasts that range from \$395 to \$995.

In these surroundings, Steinberg's Cubasis AV 1.0 is a breath of almost-fresh air. This \$149 program wraps all the essentials and even a few luxuries in an approachable interface—unfortunately, one marred by design annoyances.

## A Lean Music Machine

Cubasis AV runs on any PowerPC-equipped Mac with at least 24MB of RAM. I tested it on a 200MHz PowerBook 3400 with 32MB of RAM. Cubasis AV doesn't require a specialized digital-audio card, relying instead on the Power Mac's built-in sound circuitry.

Cubasis AV arrives on a CD-ROM that also contains 150MB of audio clips—short drum and instrument riffs from which you can assemble your own songs. Being able to build rhythm tracks from existing sounds is one of the great advantages of using an audio/MIDI hybrid: Rather than using a synthesizer's cheesy drum sounds, you can add authentic-sounding drum tracks played by real drummers. (For an overview of canned-audio options, see *Media*, August 1997.)

Unlike most sequencer packages, Cubasis AV was designed to be used with a synthesizer that adheres to the General MIDI standard, which, among other things, dictates that specific instruments be assigned specific patch numbers. (For example, a harpsichord is always patch number 7, regardless of manufacturer.) Cubasis AV's General MIDI support lets you choose instruments by selecting their names from a pop-up menu—no need to remember which patch number summons

which instrument. You can use Cubasis AV with a non-General MIDI device, but you'll need to translate the patch names into your instruments' patch assignments.

## Making Music

Cubasis AV's nerve center is the Arrange window, where you can record and work with up to 8 audio tracks and 16 MIDI tracks (see "Graphic Arrangements"). The Arrange window works like its counterparts in other programs: You can drag blocks of audio or MIDI data forward or



**Graphic Arrangements** Cubasis AV's Arrange and Audio Mixer windows let you manipulate and mix tracks.

backward within a song's timeline, and a customizable snap-to grid ensures that parts begin on the beat.

One of the beauties of MIDI is the freedom to correct flubs and tweak intonation. Cubasis AV has first-rate MIDI-editing features: A graphical editing window displays a MIDI track's data in piano-roll form, and you can change note positions by dragging them or create new notes using a pencil or paintbrush tool. When you want extra precision or need to work with non-note data, such as patch changes, you can also edit MIDI tracks in a text-based event window. If you're feeling retro, you can work with track data in standard music notation. Cubasis AV can also print scores, although it isn't intended to be used as a notation program.

Cubasis AV offers two on-screen mixer windows whose sliders and controls mimic those of a conventional audio mixer. With the MIDI Mixer, you can assign specific General MIDI instruments

to each track and adjust each track's volume and left/right panning. If your instrument uses the General MIDI GS or XG extension, you can also control its built-in reverb, chorus, and filter.

A separate Audio Mixer window lets you mix audio tracks; you can also apply real-time reverb and echo effects to your tracks. Cubasis AV's effects lack the sonic realism of high-end effects plug-ins or hardware, but they sound good—and their presence is a pleasant surprise in an entry-level program.

## Sour Notes

Cubasis AV was rock-solid in my tests, but the program's rough edges show a lack of attention to detail: The commonly used Import Audio command lacks a keyboard shortcut, and you can't drag and drop audio files from the Finder. The Transport window lacks a rewind-to-beginning button (if you experiment, you'll find that double-clicking on the Stop button has the same effect). Commands unavailable at a given time aren't dimmed, as they should be. And the program's error messages are an adventure in free-form grammar and punctuation.

Cubasis AV's printed manual is an awkwardly written 76-page booklet. A detailed manual is included in Adobe Acrobat form on the CD-ROM (which also contains some QuickTime-based tutorials), but it's no model of clarity, either.

## Macworld's Buying Advice

Cubasis AV's shortcomings don't completely dampen my enthusiasm for this program. In a world of kitchen-sink sequencers that contain features many people will never use, Cubasis AV is a refreshing change. If you're interested in testing the waters of audio/MIDI integration, particularly if you use General MIDI instruments, it's well worth considering.—JIM HEID

**RATING:** ★★ ★/5.9 **PROS:** Inexpensive; easy to use; solid MIDI-editing features. **CONS:** Poor documentation; numerous interface flaws. **COMPANY:** Steinberg (818/993-4161, www.steinberg.net). **LIST PRICE:** \$149.



# "My business can't stop when the power does..."



Back-UPS® Office™'s instant battery back-up can keep you up and running even when the power goes down.

**only \$125**  
list price

... I rely on Back-UPS® Office™ from APC."



"I've got Back-UPS® Office™ from American Power Conversion. Back-UPS Office combines world class surge protection, a \$25,000 equipment protection guarantee\* and instant, uninterruptible battery back-up power.

So when the power goes out, and it will.... I have plenty of time to save what I am working on and shut down safely.

Plus, I am protected from surge damage, keyboard lock-ups, data loss



Look for APC power protection products - starting at \$24.95

and power problems transmitted to my workstation over data and power lines."

So, if you just bought your first computer, or run a company that needs hundreds, you can depend on the reliability and peace of mind that comes with APC products. Why? It's simple. APC protects more computers for more companies in more countries than anyone in the world.

Now, that's a reason to smile.

APC's Back-UPS Office is available at:

**Mac Mall**  
1-800-328-2790

**Mac Warehouse**  
1-800-255-6227

©1997 APC. All Trademarks are the property of their owners. \* See policy for details. BF22EF • (800)347-FAXX PowerFax • E-mail: apcinfo@apcc.com • 132 Fairgrounds Road, West Kingston, RI 02892 USA

APC has won more awards for reliability than all other UPS vendors combined.



Circle 72 on reader service card



**FREE Consumer Catalog**

- YES!** I'd like to receive my FREE catalog.  
 **NO.** I'm not interested at this time but please add me to your quarterly newsletter mailing list.

Name: \_\_\_\_\_  
 Title: \_\_\_\_\_  
 Company: \_\_\_\_\_  
 Address: \_\_\_\_\_  
 City/Town: \_\_\_\_\_  
 State: \_\_\_\_\_ Zip: \_\_\_\_\_ Country \_\_\_\_\_  
 Phone: \_\_\_\_\_ Fax: \_\_\_\_\_  
 # of Macs on site? \_\_\_\_\_  
 Brand of UPS used? \_\_\_\_\_ # \_\_\_\_\_  
 Brand of Servers used? \_\_\_\_\_ # \_\_\_\_\_

**APC**  
 888-289-APCC x8250  
 Fax: (401) 788-2797  
 www.apcc.com

D7-80



# Genealogy Software

USE YOUR MAC TO FIND YOUR ROOTS

**T**HE MAC IS THE PERFECT TOOL for family-history nuts. Not only does it make recording, storing, and organizing family data efficient and enjoyable but the Internet also lets genealogists worldwide effortlessly swap information. Three software companies have revved their genealogy programs—and one is sensational.

## Family Tree Maker Deluxe

Brøderbund's Family Tree Maker (FTM) is the best-selling Windows genealogy program: Its crystal-clear design features a simple, large-font card for each husband and wife. Filing-folder tabs take you to the card for each person's parents and children, making it simple to climb up or down the family tree. Since the program recognizes names and places, its autofill feature saves typing—a necessity for a hobby that involves repetitious data entry.

Nonetheless, FTM is a flop as a Mac program. Its installer deposits an unforgivable 11 extensions into your System folder, and the program needs 10MB of RAM. For example, click on the main dialog box's close box, and the whole program unceremoniously quits. The manual highlights Windows screen shots. And a critical feature is surprisingly missing: The program doesn't accommodate photos (let alone sound or movies).

Indeed, FTM's greatest attraction isn't the program itself; it's the promise of instant research gratification. FTM links directly to a huge private Web site and can access any of 60 optional CDs filled with genealogical data. (They average \$30 apiece; this version includes three.)

The CDs include little more than public-domain government records; worse, the actual program relentlessly pressures you to buy the CDs. For example, the built-in FamilyFinder command lets you search 115 million names. Great, except that it doesn't produce any useful data on its "hits"—it simply identifies the CD you must buy to get information.

## Ultimate Family Tree Deluxe

Family Tree Maker isn't the clunkiest genealogical PC port on earth; that honor goes to Palladium Interactive's Ultimate

Family Tree Deluxe—an equally resource-hungry, Mac-hostile database that doesn't even offer good design as a consolation. This Microsoft FoxPro document takes over a minute to load and requires 35 seconds to import a ten-name text file.

Click in a blank field and try to type—nothing happens. There's no autofill, and you must put annoying slashes around each last name. You're required to burrow through three nested dialog boxes to add a spouse or attach a photo. And the program's text labels are hilariously clumsy.

To be sure, deep inside the FoxPro database beats the heart of a real genealogy program. Here you'll find you can

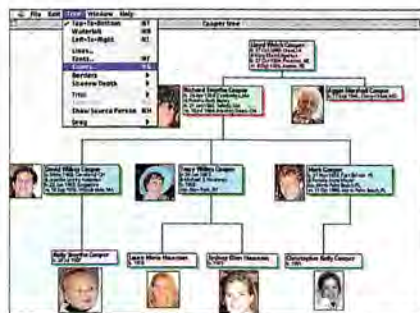

**Family Reunion 5** Reunion's SuperChart program lets you tweak family tree charts in every way.

add photos and generate tree charts. There's even direct integration with the Palladium Web site, and the Netscape Navigator-based, narrated slide show offers valuable research hints. But genealogy software should save time, not waste it.

## Reunion 5.02

If FTM and UFTD are modeled for the PC, Reunion 5.02 is blue-blood Macintosh. The results are spectacular. Talk about optimized: This fast, elegant program comes on one floppy disk. It accommodates any family setup: multiple marriages, same-sex marriages, adoptions, even unknown gender. The program's attractive "family cards" offer autofill, autocapitalization, a "ditto" keystroke that duplicates your last entry, and so on. You can drag and drop; attach pictures, sounds, and movies; and change the font, size, and even color of nearly any text.

The separate but self-launching

chart-making program instantly churns out any kind of genealogical chart. Configure charts in any orientation, complete with photos, with the option of dragging branches of your tree around before printing. (The Timeline chart, showing your clan members' life spans against a grid of history, is especially valuable.) The program doesn't offer automatic integration with Web data, but it can turn your family tree into gorgeous, hyperlinked Web pages, ready for posting online.

Most appealing is the way Reunion puts your data to work. It prints birthday calendars, marking days to remember or showing each relative's age. It even generates startling averages (such as "age at marriage" or life span) for your clan.

## Macworld's Buying Advice

Family Tree Maker Deluxe Edition II and Ultimate Family Tree Deluxe may have PC fans, but those people never had to use these clumsy adaptations. Reunion 5, on the other hand, isn't just great genealogy software; it's an outstanding Mac program. Genealogy can be a rewarding life-long quest; fast, flexible Reunion should be your companion.—DAVID POGUE

## Family Tree Maker Deluxe Edition II 3.02

**RATING:** ★★/4.8 **PROS:** Well-stocked Web site may help with research. **CONS:** Appalling RAM, hard-disk, and extension demands; slow; too much sales pressure. **COMPANY:** Brøderbund (415/382-4700, www.familytreemaker.com). **COMPANY'S ESTIMATED PRICE:** \$89.99.

## Reunion 5.02

**RATING:** ★★★★★/8.7 **PROS:** Beautifully designed; infinitely flexible; fast and stable. **CONS:** Chart maker is technically a separate program. **COMPANY:** Leister Productions (717/697-1378, www.leisterpro.com). **COMPANY'S ESTIMATED PRICE:** \$99.95.

## Ultimate Family Tree Deluxe

**RATING:** ★★/3.0 **PROS:** Integrates with Web site; useful interactive research-tips guide. **CONS:** Unusably slow; confusing, inconsistent interface; nested dialog boxes required for most functions. **COMPANY:** Palladium Interactive (812/829-4405, www.palladiumnet.com). **COMPANY'S ESTIMATED PRICE:** \$59.95.



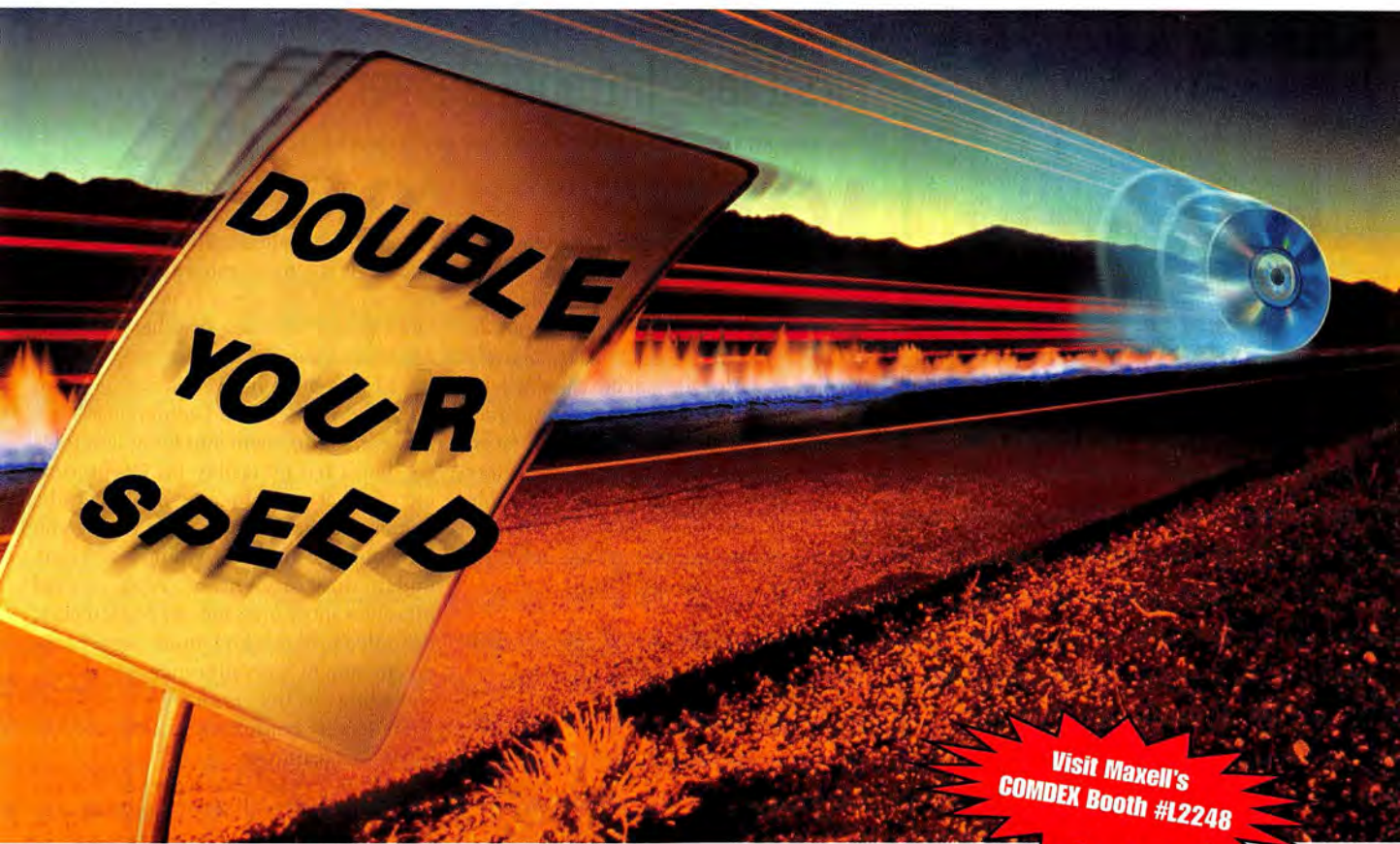

**Visit Maxell's  
COMDEX Booth #L2248**

## Using breakthrough LIMDOW® technology, Maxell brings you super-fast direct OverWrite Magneto Optical Disks.

LIMDOW (Light Intensity Modulation Direct OverWrite) technology boosts writing speeds by up to 100% over current Magneto Optical (MO) disks. That's because it requires only a single pass to rewrite new data to a disk—eliminating the need for erasing.

Now you can transfer data at an impressive 4.0 MB/second, and still have the security and convenience of a removable media with random access. Maxell's line of direct OverWrite MO disks are ideal for data storage, document imaging, file management, and multimedia applications.

On top of doubling your speed, Maxell's LIMDOW disks offer you the highest capacities available—640 MB on a 3.5-inch disk and 2.6 GB on a 5.25-inch disk. Plus, they'll be there for you down the road with durability rated at 1,000,000 rewrite cycles and an archival life of over 30 years! Look for LIMDOW capable drives from Nikon, Fujitsu, Hitachi, Pinnacle Micro, Most, Mitsubishi Chemical, Konica, and others.



Check out Maxell's entire line of data storage solutions. Whether you use floppies, cartridges, cassettes, CDs, optical disks or laser servo disks, you can count on Maxell's quality. Plus, Maxell products are backed by a lifetime warranty.

Put the "pedal to the metal" with the blazing rewrite speeds of Maxell's direct OverWrite MO disks. Got questions? Call our tech support center, or get our FREE product brochure by calling 1-888-2-Maxell (262-9355). Check out our Website at [www.maxell.com](http://www.maxell.com)



Maxell Corp. of America, 22-08 Route 208, Fair Lawn, New Jersey 07410  
Maxell Canada, 111 Staffern Drive, Concord, Ontario, Canada L4K 2R2 • (905) 669-8107

**Circle 120 on reader service card**



# FirstClass Intranet Server

FINE FOR MESSAGING, BUT INTRANET CAPABILITIES ARE SECOND-RATE

**Y**OU'VE HEARD THE SIREN CALL of the intranet: "Dump those expensive proprietary client programs and serve up your enterprise data using cheap, plentiful Web browsers. On the Web you can do anything. Come closer!" Alas, many a corporate sailor has been capsized by expensive server software, complicated programming, and quirky user interfaces. SoftArc promises to smooth the waters with a special version of its venerable FirstClass messaging system, newly outfitted for intranet duty. But although First Class Intranet Server (FCIS) 1.0 retains

delivers it to users. Curiously, it provides no access to FirstClass conferences for NNTP clients (news readers). Minimal documentation for the news gateway makes setup difficult, and the server is unable to filter news, gather statistics, or otherwise manage Usenet message content.

FCIS's built-in Web server lets you publish documents and conferences simply by dragging them into FirstClass folders, but it has no facility for CGI scripting or other programming. Although the manual implies otherwise, in reality you can only *view* FirstClass content; you can't update directory entries, reply to mail messages, post messages to conferences, or upload files. The most significant enhancement to conferences—message threading—is mysteriously absent from Web-served conferences, as are other FirstClass features.

Although the Web server falls short as a true intranet platform, some users may find it useful for publishing content the general public can read. Unfortunately, the Web server's performance limits that public to a small audience indeed. Tests in which only ten simultaneous users access the server show that it bogs down easily, with response times of tens of seconds when the users are browsing conferences. Even when serving static HTML, the server drags with only two or three simultaneous users.

## Macworld's Buying Advice

As a powerful enterprisewide messaging environment, FirstClass has no peer in the Macintosh world. Existing users will find the new Internet server features useful, and the POP3 and SMTP compatibility makes the product attractive for handling Internet e-mail. Just don't be fooled into thinking FirstClass Intranet Server has anything to do with real intranet information serving.—MEL BECKMAN

**RATING:** ★★ ★/6.5 **PROS:** Integrated POP3, SMTP, NNTP, and HTTP servers; MIME compatibility; cross-platform support. **CONS:** Can't update content via Web interface; slow Web-server software; weak documentation. **COMPANY:** SoftArc (905/415-7000, www.softarc.com). **LIST PRICE:** 10 users, \$999; 50 users, \$2,723.

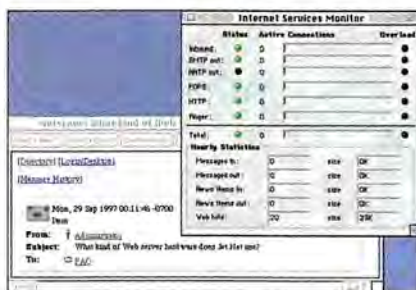

**WebTalk** FirstClass Intranet Server's built-in HTTP server software lets you publish traditional FirstClass conferences on the Web for public viewing.

the proprietary client functions and powerful features of the original FirstClass package (see *Reviews*, March 1997), it falls short of delivering on its promise to provide a complete intranet platform.

FCIS's client sports a few enhancements, such as full MIME compatibility and threaded conferences, but the big news is the package's built-in SMTP, POP3, NNTP, and HTTP (Web) server features, which let you access FirstClass messages over the Internet using a standard Internet mail client or a Web browser. The servers run on either Macs or Windows-based machines and provide access to the FirstClass user directory via Internet Finger clients.

The FCIS SMTP and POP3 servers deliver e-mail to the Internet and to POP3 mail clients, respectively. The SMTP server supports Internet mail relaying, but the POP3 server has no advantages over any other POP3 server besides its integration with FCIS.

The NNTP server collects Usenet news from an upstream news feed and



**Macworld**  
LAB TEST

To buy smart when you're choosing Mac OS hardware or software, you've got to put it to the test.

Macworld Lab is on the job, testing, scrutinizing, and evaluating the performance and quality of the products you need. With real-world testing, we measure performance by real-life standards. Using the system and applications you'd use to complete the tasks you're faced with every day, our experts come up with answers that matter to you.

You can rely on Macworld Lab Test results—We test the products the way you use them.

**Macworld**  
THE ESSENTIAL MACINTOSH® RESOURCE



**PowerPrint**

Need to connect your Mac to a PC-printer?  
Call 1-800-564-0644



*for your file*



## Because one day you'll need to print to a PC-printer and you won't remember where the heck you saw this ad

Sooner or later, you'll need to connect your Mac to a PC-printer. After all, your clients use them. Your favorite hotels use them. Even your co-workers use them. The good news is that it's easy to connect to a PC-printer. You just need PowerPrint.

For only \$99, PowerPrint has the software and smart cable that makes it all possible. You'll be able to print from your Mac to over a

thousand different printers from companies like Canon, Epson, HP, Okidata, Panasonic and more.

So get PowerPrint if you think you'll be using a PC-printer anytime soon. Or just keep us on file until you do need us. Because you will need us.



Call us: 800-564-0644  
Or visit: [www.infowave.net](http://www.infowave.net)



# PowerPrint®

4664 Lougheed Highway, Suite 188, Burnaby, BC, Canada V5C 6B7  
PHONE: 604.473.3600 FAX: 604.473.3699 E-MAIL: [info@infowave.net](mailto:info@infowave.net)  
© 1997 Infowave Wireless Messaging Inc. Infowave, the Infowave logo, PowerPrint, and the PowerPrint logo are trademarks of Infowave Wireless Messaging Inc., which may be registered in certain jurisdictions. All other trademarks are property of their respective owners.



Circle 32 on reader service card



# Apple Network Administrator Toolkit 2.0

SUPERB EDUCATOR-ORIENTED SUITE

**Y**OU DON'T NEED TO BE A WIRE-head to appreciate the Apple Network Administrator Toolkit. In fact, ANAT has the most to offer to teachers, school administrators, and others who manage computer labs alongside their other jobs, by simplifying complex tasks, automating repetitive procedures, and adding powerful new features to the Mac OS's built-in networking software.

ANAT 2.0's three programs can be used together or separately. Network Assistant 3.0 allows remote management of Macs, AtEase for Workgroups 5.0 lets you create customized Mac client/server environments, and User and Group Manager 1.1 simplifies the process of managing groups on multiple machines.

Network Assistant lets administrators perform tasks on a group of Macs, from a single administration system. Because Network Assistant 3.0 supports TCP/IP, client and administration machines don't have to be on the same AppleTalk net-

work; they can interact via the Internet. Some tasks (such as changing IP addresses or installing software) must be done one machine at a time, while others (such as copying files and rebuilding desktops) can be performed on multiple machines.

Network Assistant's latest version expands its tracking capabilities, but it isn't just for monitoring and controlling technical information. Teachers will appreciate the screen-sharing feature, which allows them to perform tasks such as darkening all the monitors in a student lab or making the monitors' screens mirror another system's. Administrators can also observe any number of screens on the network, with or without the knowledge of the person using the client machine. A new option allows eyeballs to be displayed on a client monitor when it's being observed (see "Eyes Only"). The new version allows screen sharing and observing over LocalTalk networks and 28.8-Kbps modems (in addition to Ethernet and faster dial-up links), but screens are slow

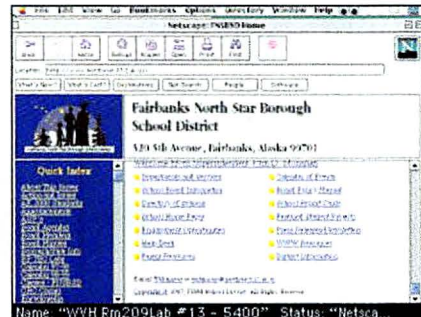

**Eyes Only** Tiny eyeballs in the menu bar alert students that their instructor is watching their screens.

to redraw via low-bandwidth connections.

AtEase for Workgroups lets administrators customize the user interface and add security features on client machines. It works well with servers running AppleShare File Server version 4.2.1 or AppleShare IP 5.0. The new version proves dramatically easier to install and configure than previous versions.

When students log in, they see environments chosen and customized by the administrator. The new version still doesn't provide client documentation for student use. AtEase 5.0 offers new options for automatically updating preferences within Internet applications (such as Netscape Navigator bookmarks) each time a user logs in to the network. Version 5 also works well with AppleShare IP 5.0 Web Server and Apple's eMate Server.

User and Group Manager 1.1 handles user and group creation for both AtEase and AppleShare server administration. It greatly simplifies group-management procedures across multiple servers.

## Macworld's Buying Advice

Apple Network Administrator Toolkit 2.0 takes much of the repetition—and the risk—out of managing large networks. The new version lets you administer networks thousands of miles away via the Internet without a hitch. This suite is a must-have for most anyone who administers a Macintosh network in an educational environment.—GEORGE

BECKMAN & TODD SHECHTER

work hard and fast. do it with style.

1.800.688.2446 x622  
www.agio-designs.com/mw

free catalog

AGIO DESIGNS™  
furniture for the way you do business



# Some Tools Change the Way We Work. Forever.



## THE WHEEL

Tired of going around in circles shooting, digitizing, editing, and compressing digital video? Maybe you haven't had the right tool for the job. Let Hitachi's new MP-EG1A MPEG camera put you in the fast lane. It's the only digital video camera in the world that creates MPEG files—and in real time, no less! Now you can transfer MPEG or JPEG files by directly connecting to the PC-type III slot in your PowerBook or using the optional SCSI Adapter (MPADS1A). And nothing's simpler than dropping the MPEG video clip into your QuickTime™ 3.0 Mac software. That's a real productivity tool.



## THE MPEGCAM

You'll get a lot more mileage out of the MP-EG1A, too. Record 20 minutes of MPEG-1 digital video. Snap 3,000 JPEG stills—just a click away from pasting into Web pages and layouts. Or grab 4 hours of audio. With MPEG, JPEG, and audio in a compact one-pound package, the MP-EG1A is sure to become the heart of your production tool chest. And with photo-quality auto-feed printing (only 50 seconds per page), the Hitachi VY60DA digital photo printer makes the perfect companion tool. So why spin your wheels when you can tool around in the Hitachi MP-EG1A today!

Capacity specifications are approximate.

# HITACHI

A TOTALLY NEW VISION

[www.mpegcam.net](http://www.mpegcam.net)

1-800-HITACHI FAX: 1-770-279-5699



## SECOND LOOK

## PrimeraPro Elite

PRINTER STILL FAILS TO MAKE THE GRADE

**T**WO MONTHS AGO, FARGO'S dye-sub/thermal-wax printer earned a tepid two-star rating. Due to testing irregularities, we agreed to give the PrimeraPro Elite another look. Unfortunately, we encountered so many additional problems in our retesting that we still can't recommend this product.

The original review complained about the printer's streaky output when imaging Macworld Lab's Adobe Illustrator test image (see *Reviews*, November 1997). Fargo representatives maintained that we had mistakenly used CMY ribbon with CMYK paper, and our retesting indicates that this was indeed the case, although minor streaking still occurred.

Our experience highlights a serious issue with the Elite's consumables: neither the ribbons nor the paper sports any means of distinguishing CMY from CMYK; our experienced lab analysts couldn't tell the difference. But with the correct supplies installed, the printer still displayed other serious problems—even after Fargo represen-

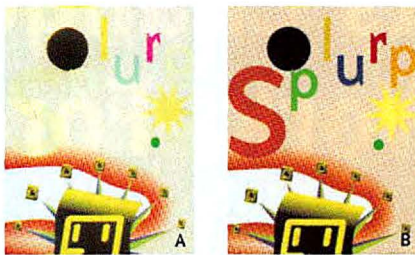

**Knowing Right from Wrong** The PrimeraPro Elite's output (A) shows its inability to properly render the type in our complex FreeHand file (B).

tatives visited Macworld Lab to ensure that our testing was sound.

Prints of our Adobe Photoshop test document were unacceptably oversaturated; primary colors in particular suffered from unpleasant, garish hues. Fargo maintains that the oversaturation is due to the fact that our test image is a CMYK file, and in fact, RGB Photo CD images we printed were noticeably superior. At this price, though, you shouldn't have to compromise.

In printing our Macromedia FreeHand test document, colored type appeared as white letters reversed out of striped colored boxes. Reinstalling the driver solved the type-reversing problem, but the letters' colors still failed to print properly (see "Knowing Right from Wrong").

Circular objects in the same file were rendered as many-sided polygons, and numerous graphic elements had noticeable white halos. Fargo representatives maintain that these issues—except for the type—are a problem with QuickDraw, even though spot-tests on competing ink-jet printers displayed none of the same quirks.

Fargo plans to introduce a \$465 PostScript Level 2 software option by the time you read this. Although we have not tested this product, it stands to reason that it could solve many—if not all—of the problems we experienced with our FreeHand file.

**Macworld's Buying Advice** Unfortunately, the PrimeraPro Elite's print quality still falls below our basic expectations for a dye-sub printer. Quality issues aside, though, there are plenty of other reasons to look elsewhere. The consumables are confusing, and the Elite's price point is way out of line considering its level of performance.—SUZANNE COURTEAU

**RATING:** ★★/4.5 **PROS:** Full-bleed letter-size prints; inexpensive for dye-sub/thermal-wax combo; knowledgeable technical-support staff. **CONS:** Unacceptable dye-sub prints. **COMPANY:** Fargo Electronics (612/941-9470, www.fargo.com). **LIST PRICE:** \$2,195.

## Timbuktu Pro 4.0

BETTER THAN EVER FOR REMOTE ACCESS AND CONTROL

**F**ARALLON'S TIMBUKTU HAS ALWAYS been the next-best thing to being there, letting you reach out and touch a distant Mac over a LAN, the Internet, or a dial-up connection. It lets you share screens, exchange files and messages, and conduct text chats with any number of remote users simultaneously. And that was just the *old* version; the new version adds a multitude of nifty features and refinements.

Timbuktu Pro 4.0 is Open Transport-native, offering much faster file transfers and the ability to recover a dropped transfer where it left off—a real boon for modem users. The file-exchange function also features an array of new commands for navigating directly to folders and renaming and finding files. You can create a Drop Sender icon for a specific destination machine and then send files to that destination simply by dragging them onto the icon. A sophisticated new Intercom feature lets you talk to remote users via the Mac's built-in audio hardware, with voice compression for good performance even over

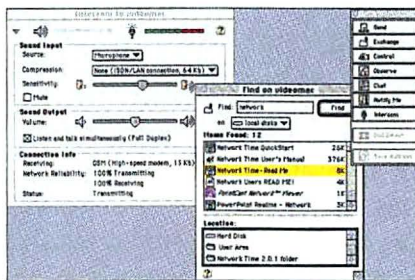

**Walk and Talk** With Timbuktu Pro 4.0, you can walk through a remote system's files, using the Find File command, and you can use the Mac's built-in audio hardware to converse with remote users.

slow modem connections. Timbuktu Pro 4.0 is also fully AppleScript- and UserLand Frontier-enabled and includes a slew of ready-made scripts for such chores as remote backup and folder synchronization.

Timbuktu is a worthwhile tool for its file-transfer performance alone. On a 100BaseT network, Timbuktu moved data at a megabyte per second (about 50 percent faster than version 3.0); AppleShare IP took 3 seconds per megabyte to move the same files. Over a 128-Kbps ISDN connection, Timbuktu was five times as fast as AppleShare IP.

Timbuktu Pro 4.0 retains version 3.0's popular features (see *Reviews*, January 1997): pop-up messaging, remote-user-activity

notification, drag-and-drop file transfers, and a Netscape plug-in for compatibility with Netopia Virtual Office. The only negative in this release is Farallon's failure to fix the awkward user-interface problems, such as the nonintuitive placement of some menu items and the difficulty in saving settings. While you can write AppleScripts to get around these problems, most users don't want to become programmers just to fix a few interface glitches.

**Macworld's Buying Advice** With a raft of new features, Timbuktu Pro 4.0 is better than ever for remote access and control. Its blazing file-transfer speed makes it indispensable for exchanging large files, such as video streams. And because it's cross-platform for network and dial-in access, it's sure to be the darling of enterprises that support both Mac OS and Windows desktop machines.—MEL BECKMAN

**RATING:** ★★★★★/8.5 **PROS:** Sophisticated access for any remote user; fast file transfers; can resume file transfers after failure; remote-searching and intercom features. **CONS:** User interface still awkward. **COMPANY:** Farallon Communications (510/814-5000, www.farallon.com). **LIST PRICE:** One user, \$199; two users, \$259; ten users, \$899.







## Private File 2.0

ADEQUATE, SIMPLE ENCRYPTION

**A**S MORE PEOPLE COME TO RELY on the Internet for sending and receiving information, encryption software—utilities that protect valuable data from prying eyes en route—has moved from the realm of the esoteric into the mainstream. Aladdin Systems' Private File 2.0 provides a simple but effective way for people to encrypt files that travel over public networks.

Private File consists of a pair of applications for encryption and decryption. Operation of either component is easy. To encrypt your files, just select them and drag them onto Private File. You're presented with a dialog box in which you enter the password or phrase used to secure the data. The encryption utility first compresses the files and then encrypts the resulting archive.

Decrypting a Private File archive is an even simpler matter of either double-clicking on encrypted files or dragging them onto the decryption application. Upon opening the archive, Private File asks you for the password, and—after a brief wait as they're decrypted and decompressed—the files are deposited on your hard disk.

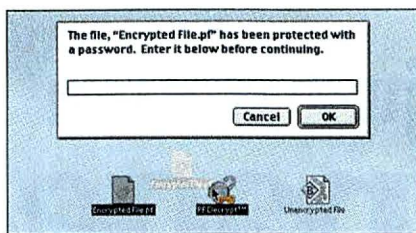

**Simply Secure** To encrypt or decrypt a file, just drag it onto the appropriate Private File component and enter a password.

Private File 2.0 ships on a hybrid CD-ROM containing both Mac OS and Windows versions of the software. Files encrypted on one platform can be decrypted on the other; the software can even automatically convert line breaks in text files if desired.

Because of current U.S. government regulations on encryption software, Private File is available in two versions: an export version that uses relatively insecure keys that are 40-bits long and a domestic version that uses much stronger, 128-bit keys. Although the domestic version cannot create 40-bit encrypted files, the decryption utility that comes with both the domestic and the imported versions can handle 40- and 128-bit files.

Private File also lacks the ability to save its files in a self-extracting format (similar

to Stuffit's convenient .sea archive scheme), in which a minimal decompression engine is attached to the compressed file. This type of capability, or a freely distributable decryption component, would make Private File much more useful.

As shipped, Private File's Finder-integration features work only under System 7. Aladdin representatives said that a free patch to version 2.0.1—which provides full Mac OS 8 feature compatibility—should be available by the time you read this.

**Macworld's Buying Advice** Although the simplicity of Private File is perfectly suitable for encryption neophytes, a more capable package, such as PGP for Personal Privacy 5.0, from Pretty Good Privacy (650/572-0430, www.pgp.com), will better serve most users' security needs in the long run. PGP—the de facto multiplatform standard—offers a stronger feature set, seamless integration with popular e-mail packages, and a much better value.—STEPHAN SOMOGYI

**RATING:** ★★★/5.2 **PROS:** Drag-and-drop simplicity; transparent cross-platform use. **CONS:** Limited feature set; no self-extraction capability; no OS 8 Finder integration. **COMPANY:** Aladdin Systems (408/761-6200, www.aladdinsys.com). **LIST PRICE:** Two-user license, \$99.95.

## Vibe Enterprise

HIGH-END JAVA TOOLS FOR BUSINESS

**F**OR ALL ITS POTENTIAL, JAVA has some serious shortcomings from Mac developers' perspective. One is the sometimes months-long delay in the availability of Mac versions of the latest tools (JavaSoft's JDK 1.1 is a notable example); another is the platform-specific appearance glitches that typically bother Java applications. Visix Software's Java development environment, Vibe Enterprise 1.0.1, addresses these problems, along with the absence of Java in large-scale business solutions. The Mac and Windows (95 and NT) releases were nearly simultaneous, the application interface is native to each platform, and this version was designed specifically as an enterprise-scale toolkit.

The initial release of Vibe was a \$49.95 cross-platform development tool for C++ programmers moving to Java. The much higher price of Vibe Enterprise reflects the addition of libraries and sample Java code for designing stand-alone databases and providing client access to Oracle and Sybase databases. Currently, its only competition is Symantec's recently announced \$495 Visual Cafe for Java Database Development,

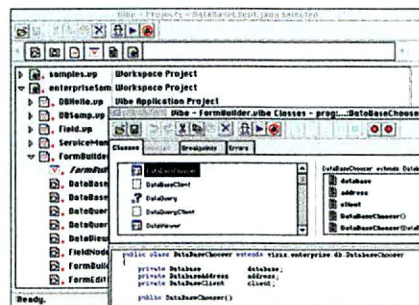

**Class Act** The feature that distinguishes Vibe Enterprise is a large library of classes for accessing and querying popular big-business databases.

which also promises links to Oracle, Sybase, and ODBC-compatible databases.

Like the more familiar Metrowerks, Roaster, and Symantec environments, Vibe has a fast text editor and a graphics-oriented dialog editor. It includes a fairly complete debugger—which unfortunately lacks conditional breakpoints—along with a browser for examining the megabytes of classes for basic Java and its more advanced database uses. Although Vibe's modify-and-rebuild cycle seems a bit slower than Metrowerks', the Java applications themselves are impressively fast; as stand-alone applications, they run at near-C++ speeds. And although Vibe's libraries are

proprietary, the tutorial offers plenty of entry-level material to copy and paste.

Professionals will appreciate the ease of designing complex database applications with Vibe's powerful, hierarchical Service Broker (which manages multiple database connections) and slick, interactive SQL query builder. Another clue that Vibe is for professionals only is that it's still under construction: In Visix's own examples, for instance, scrolling text sometimes overwrites itself. Visix is conscientious about tracking, documenting, and fixing bugs, but the coming support for JDK 1.1 will likely only add to the list.

**Macworld's Buying Advice** Vibe Enterprise is an excellent tool for Java professionals doing database work for medium-size to large businesses. At its current price and state of development, it's not simple enough for beginners, but it's great for designing Web access to corporate Sybase or Oracle databases.—CHARLES SEITER

**RATING:** ★★★★/7.2 **PROS:** Powerful classes for serious database work; finished applications run quickly. **CONS:** Leisurely performance; generous, though well-documented, assortment of bugs. **COMPANY:** Visix Software (703/758-8230, www.visix.com). **LIST PRICE:** \$1,995.



# Microtek image quality now comes in a sleek, little box.

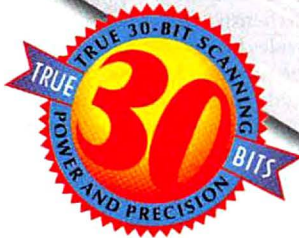
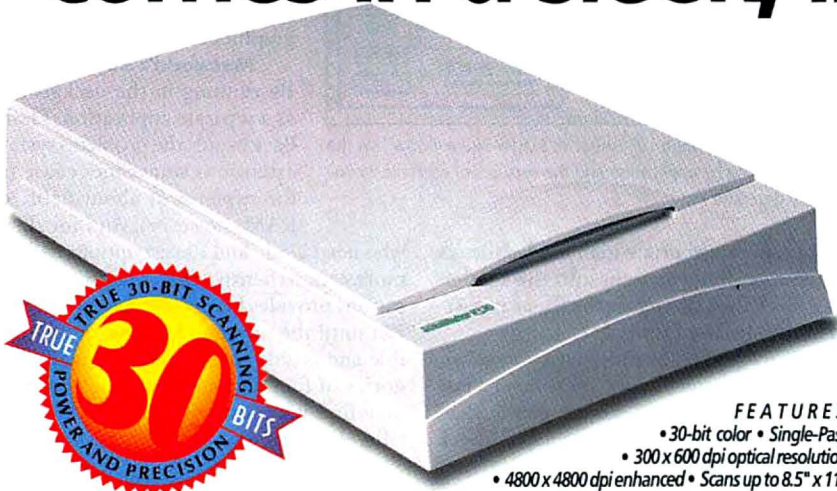

- FEATURES:**
- 30-bit color • Single-Pass
  - 300 x 600 dpi optical resolution
  - 4800 x 4800 dpi enhanced • Scans up to 8.5" x 11"
  - New FlexScan™ Lid • Zero Reflection Design Technology™

## MICROTEK ScanMaker V310

Introducing the all new ScanMaker® V310, the 30-bit color scanner from MICROTEK, the most trusted name in desktop scanning. If you don't have a lot of room on your desktop then this compact-sized scanner will fit right in. If you don't have a lot of time, but want to get the best quality images into your computer, then the ScanMaker V310's speed and color fidelity will impress you. After all, it is a MICROTEK.

So, whether you need to spruce up business proposals, capture images for a Web page, archive family photos or save the artwork your kids bring home from school — the software included with the ScanMaker V310 will let you do all of this and more! The only limit is your imagination. With the ScanMaker V310, scanning was never so easy or so much fun!

For more information, contact your nearest MICROTEK reseller, or MICROTEK at 1-800-654-4160 or visit our Web site at [www.microtekusa.com](http://www.microtekusa.com).

### INCLUDES:



Kai's Photo Soap (full-application) from MetaCreations • MicroFrontier's Color It! • Caere's OmniPage Limited Edition OCR software for scanning pages of text • MICROTEK's award-winning ScanWizard™ scanner controller software

## Also from MICROTEK: ScanMaker E3



Quite possibly the most popular 24-bit color scanner on the market. Winner of numerous awards and accolades. Features a large scan area, image editing, OCR software, and ScanWizard. ONLY \$149 (suggested street price)!

## MICROTEK ScanMaker E6



New Lower Price  
**\$299!**  
ScanMaker E6 standard  
Suggested Street Price.  
Was \$359

The 30-bit ScanMaker® E6 color scanner features a large scan area, 600 x 1200 dpi optical resolution, superb image quality and a quick SCSI interface. Only \$299 (suggested street price)!

COMING SOON: See our Web site for our new **Tabloid-Size Color Scanners!**



**MICROTEK**  
Better Images Through Innovation.  
[www.microtekusa.com](http://www.microtekusa.com).

Prices mentioned are United States suggested street prices. Bundled software on CD-ROM / any retail packaging depicted is not available with this product.

All products mentioned are trademarks or registered trademarks of their respective holders. Caere Corporation (1-800-535-7226). Prices, specifications and software bundles are subject to change without notice. V310MW0198



# FlashBack

FILE UTILITY TRACKS AND RESTORES PREVIOUS VERSIONS

**T**HOREAU WROTE "SIMPLIFY, SIMPLIFY," and for better or worse, Aladdin Systems has taken his famous maxim to heart in designing its latest utility. FlashBack 1.0, which remembers and restores previous versions of any file, is as lean and uncomplicated as it gets—so much so, in fact, that using FlashBack is actually more work than it should be.

The premise is straightforward: You tell FlashBack which files to monitor, and it runs in the background and records the contents of and changes to successive versions of each file (up to the number of versions you specify) every time the file is saved, every time you close the file, or at user-defined intervals. You can set those options for all files, for all the files of a specific application, or for individual files.

The FlashBack window (see "Déjà Vu All Over Again") lists every version of all the files being tracked. If you need to open a previous version—to undo changes you can't otherwise undo, to restore something edited out way back when, or to recover a lost or damaged file—you either double-

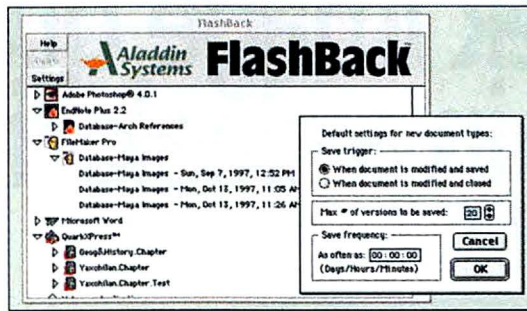

**Déjà Vu All Over Again** FlashBack's Finder-like window lists the files it's tracking by application and the versions of each file it contains by date and time.

click on the appropriate item in FlashBack's window or drag the item into the Finder. FlashBack then re-creates the file as it existed at the specified time.

In its extreme simplicity, however, FlashBack is needlessly inefficient. For example, dragging and dropping individual files or groups of files into the FlashBack window is the only option for specifying files to be tracked—an unwieldy one if your files are organized in many nested folders. FlashBack has no command for automatically tracking all newly created files or all the files of a specific application or in a particular folder. (In fact, it has no meaningful commands at all.) And the FlashBack win-

dow doesn't let you organize an unmanageable number of documents into folders. In addition, even though FlashBack uses a difference engine to record version changes, the program takes up multimegabytes of hard-disk space when asked to track large graphics files.

### Macworld's Buying Advice

By running in the background as a separate application, FlashBack avoids the problems system extensions sometimes cause (at the expense of about 650K of RAM, however). And for those who need Undo and Revert options that are more comprehensive than what their applications provide, FlashBack may fill the bill. But until the program becomes more flexible and is able to track user-defined categories of files automatically, the rest of us may find it almost as easy to back up our edits the usual way.—ROBERT C. ECKHARDT

**RATING:** ★★/6.0 **PROS:** No-hands background backups of earlier versions of files. **CONS:** Inflexible operation; lacks automatic tracking options. **COMPANY:** Aladdin Systems (408/761-6200, www.aladdinsys.com). **LIST PRICE:** \$69.95.

# MathType 3.5

MATH PUBLISHING, NOW WEB-READY

**M**OST MAC USERS ALREADY HAVE a bit of Design Science's MathType on their hard disks—a smaller version masquerades as the Equation Editor found in popular word-processing programs, such as Microsoft Word. The complete version of MathType sports the same simple interface: Palettes with common math symbols let you assemble equations rapidly.

Version 3.5 offers enhancements that range from merely convenient to downright essential. MathType now installs its own tool-bar button and commands in Word and lets you customize palettes and store macros for rewriting complex expressions. Like previous versions, MathType automatically handles finicky spacing and symbol-sizing details for perfect printed output.

An essential new command lets you save equations as antialiased GIFs (see "Math for the Web") that yield online math pages that look sharp and identical on all platforms. MathType also produces HTML code for any equation saved as a GIF, but the limitations of HTML make the GIF format aesthetically superior. Teachers will welcome

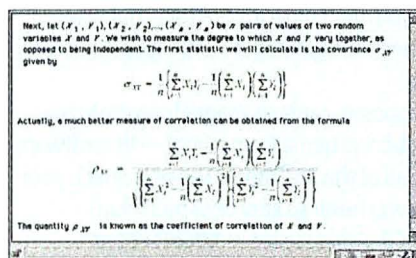

**Math for the Web** Version 3.5 brings MathType's excellent printed-page output to Web documents.

a new set of features for reproducing classic textbook geometry notation.

Although Wolfram's Mathematica 3.0 (see *Reviews*, May 1997) uses a set of symbol templates similar to MathType's and creates "live" equations (rather than static images), MathType retains some key document-production advantages over its competitors. First, because MathType doesn't carry the symbol-interpreting overhead of Mathematica, laying out a few pages in MathType is dramatically faster. Also, because MathType limits its prowess to simple equation production, the program fits on a single floppy and runs well on any Mac. As you would expect, this version also offers technical-publishing-standard T<sub>E</sub>X output.

Unfortunately, MathType's orientation toward carefully defined output appearance

comes at the expense of interoperability with straight-ahead math programs such as Mathematica or Maple V, from Waterloo Maple (see *Reviews*, November 1996). It would be a great convenience to be able to use MathType equations as input to Mathematica or Maple, instead of having to leave the equations as static pictures. In its current marketplace—where MathType is used mostly as a word-processing aid for generating exams, quizzes, and reports—this isn't a crucial defect. Design Science should consider writing a utility that translates the program's output into input for key programs.

**Macworld's Buying Advice** Equation-writing occurs more often in an instructional context than in any other, and MathType is ideally suited for the production of academic documents. As an upgrade to the ubiquitous Equation Editor in Microsoft Word and ClarisWorks, it quickly pays for itself in time saved.—CHARLES SEITER

**RATING:** ★★★★★/8.6 **PROS:** Easy to use; no cross-platform glitches; fast; compact. **CONS:** Equations don't serve as "live" input for other math programs. **COMPANY:** Design Science (562/433-0685, www.mathtype.com). **LIST PRICE:** \$199 (upgrade, \$29; upgrade from MS Word Equation Editor, \$89).



# Who wants some Wang?

FRESH FROM THE CREATORS OF DUKE NUKEM 3D™

## LO WANG™ IS SHADOW WARRIOR™ for Macintosh®

LO WANG IS COMING TO THE LAND OF THE RISING SUN

TO TURN OUT THE LIGHTS. SHADOW WARRIOR.

THE ZEN IS GOING TO HIT THE FAN.

AVAILABLE  
NOW



MORE DETAIL, INTERACTIVITY, GAGS AND HILARIOUS LO WANG SPEAK THAN DUKE NUKEM 3D.

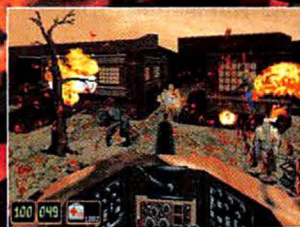

SWIM, DUCK, JUMP, DRIVE VEHICLES, CLIMB LADDERS, GO ANYWHERE, DO ANYTHING.



THROWING STARS, KITANAS, UZIS, FOUR-BARREL SHOTGUNS, RAIL GUNS, GOREWEAPONS... THE BIGGEST, BADDEST ARMORY IN GAMING HISTORY.



BUILT FROM THE GROUND UP FOR THE ULTIMATE "WANG BANG." CHOOSE FROM DEATHMATCH, CO-OP, TEAM PLAY OR CAPTURE-THE-FLAG MODES.

Created by Mac conversion by

3D  
REALMS

Lion  
ENTERTAINMENT, INC.

800-229-2714

Call for a free catalog or visit our website at [www.wizworks.com](http://www.wizworks.com)

Shadow Warrior™ © 1997 3D Realms Entertainment, Inc. Lo Wang and his likeness are trademarks of 3D Realms Entertainment, Inc. All rights reserved. All other trademarks are property of their respective owners.

Available at

COMPUSA  
1-800-COMPUSA  
1-800-266-7872

MacSoft®

An Affiliate of GT Interactive Software  
2300 Berkshire Lane, Plymouth, MN 55441 612-509-7600

Circle 28 on reader service card



# Internet Station

SLOW, PRICY INTERNET LAN ACCESS

**D**ESIGNED TO ALLOW SHARED modem or ISDN Internet access, Dayna's new Ethernet TCP/IP router promises to get network users onto the Internet quickly and easily. The NetCenter Internet Station 1.0 lives up to that promise, but at a higher price and slower speed than a dedicated ISDN router.

The Internet Station is a modem-size box with an Ethernet connection and three communications ports—one serial port and two PC Card slots—for either analog modems (up to 56 Kbps) or an ISDN terminal adapter (TA). You can connect a mix of Mac, Windows, Unix, and other systems using Dynamic Host Control Protocol; the Internet Station automatically sets the IP address and other TCP/IP values on every machine. Web-based configuration and an excellent online guide let you set up the router in a matter of minutes.

The Internet Station senses outbound Internet traffic and automatically dials your ISP, disconnecting after a period of inactivity. To the ISP, your entire network looks like a single dial-up user. Indicator lights show network activity and modem status,

while the Web interface provides detailed error messages and other diagnostic aids. But despite its ease of use, the Internet Station may be problematic for Internet access. The product lacks remote-administration capabilities, making it difficult for ISPs to support. Although the Web-based setup is handy, most ISPs offer free router configuration services anyway.

The Internet Station also supports modem sharing for Windows computers, letting network users send faxes and access modem-based services, using two of the three modems while the third is connected to the Internet. Considering that other modem-sharing solutions cost \$1,000 or more, this useful feature could easily justify the price of the product. Alas, because Dayna supplies no Mac modem-sharing software, Mac users can take advantage of only one of the unit's three ports.

The unit's performance is lackluster with multiple users connected over a 56-Kbps modem; modems are just too slow to share effectively. Replacing the modem with an ISDN TA yielded a throughput of 100 Kbps and acceptable response time with a half-dozen users. However, a dedicated ISDN router costs less than the Internet Station plus an ISDN adapter, and you get better performance into the bargain—the dedicated router offers 128-Kbps synchro-



ANROLD TIOECCO

nous throughput and data compression.

**Macworld's Buying Advice** Most users will likely find any modem connection too slow for shared Net access. Unfortunately, an Internet Station plus an ISDN TA—the only solution for acceptable speed—costs more than a dedicated ISDN router and is much slower. The modem-sharing feature could have cinched the deal for Mac users looking for an all-purpose communications device, but as it stands, this one-trick pony just isn't very attractive.—MEL BECKMAN

**RATING:** ★★/4.8 **PROS:** Simple Web-based configuration; allows unlimited users on a single Internet account; supports ISDN. **CONS:** Expensive; too slow with a modem; modem sharing non-functional; no remote administration. **COMPANY:** Dayna Communications (801/269-7200, www.dayna.com). **LIST PRICE:** \$659.

New! DiskExpress Pro now accelerated for Power Mac and much more!

## DOUBLE YOUR DISK SPEED!

Alsoft DiskExpress Pro



Without optimization, your disk performance slows to a crawl. Basic optimization may restore some of your disk's original performance. Only DiskExpress Pro can double your disk speed by providing faster access to the files you actually use!

DiskExpress Pro 3.0 vs. Norton Speed Disk 3.5

	DiskExpress Pro 3.0	Norton Speed Disk 3.5
Makes your Mac faster than new by monitoring actual file usage?	YES	NO
Groups frequently used files together for optimum speed?	YES	NO
Allows you to schedule or immediately perform a complete optimization of all disks without having to restart your Mac?	YES	NO
Verifies accuracy of both read and write activity to ensure data safety during optimization?	YES	NO
Optimizes the busiest of AppleShare™, File Share™, and Internet/Intranet servers without interrupting productivity or taking the server off-line?	YES	NO

©1997 Alsoft, Inc. P.O. Box 917 • Spring, Texas 77381-0917 USA. Alsoft and DiskExpress are registered trademarks of Alsoft, Inc. Other product names are trademarks of their respective companies.

THE UTILITY COMPANY

www.AlsoftInc.com

ALSOFT

800-ALSOFT1

Circle 140 on reader service card



# Permission to Engage

# TOP GUN™

## FIRE AT WILL

You are **Maverick**—  
and you've got  
**your orders** on your  
**mind**. **Commander**  
**Hondo**  
on your back and  
**MiGs** on your tail.  
So **fuel up**.  
Strap yourself in.  
And let 'em know your **bark**  
is nothing...  
next to your **bite**.



High-resolution voxel engine creates a photo-realistic experience

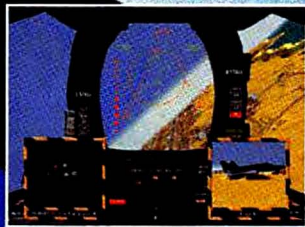

Lead your wingmen into fierce dogfights and air-to-ground combat in over 40 missions



Only the best of the best graduate from Top Gun



Training missions at the Naval Air Station at Miramar prepare you for intense combat

TOP GUN © 1997 Paramount Pictures. All Rights Reserved. Spectrum HoloByte is an authorized user. Spectrum HoloByte is a registered trademark of Spectrum HoloByte, Inc. MicroProse is a registered trademark of MicroProse, Inc. or its affiliated companies. All other trademarks are the property of their respective holders.

**MICROPROSE**

800-229-2714

Call for a free catalog or visit our website at [www.wizworks.com](http://www.wizworks.com)

**MacSoft®**

An Affiliate of Spectrum Interactive Software  
2800 Berkshire Lane, Irvine, CA 92614 612.597.600

Circle 23 on reader service card



## Power3D

3-D-ACCELERATION CARD FOR GAMES

**J**UST A YEAR AGO, HARDWARE-based 3-D acceleration promised to be the Next Big Thing for Mac gamers, and ATI delivered with its Xclaim VR card. For gamers, the latest—and greatest—PCI-based solution is TechWorks' Power3D acceleration card.

But just for gamers. Unlike the ATI card, the Power3D's sole purpose is to accelerate the sort of 3-D graphics used in games—2-D graphics continue to be delivered by your Mac's on-board video. Because the Power3D can't display 2-D and 3-D video concurrently, it's not intended for use with design applications.

The Power3D's external pass-through cable routes the Mac's video output through the Power3D card. When an application supporting the Power3D launches, 2-D video bows out and the Power3D's 3Dfx Voodoo Graphics chip set—the de facto standard for PC-game acceleration—takes over. This bodes well for Mac entertainment enthusiasts: Nearly every PC game that supports hardware-based 3-D acceleration now comes in a 3Dfx-compatible version; those games ported to the Mac will



**Before and After** Power3D gives Quake the subtle shadows and textures shown on the right, compared with the pixelated graphics generated by standard equipment on the left.

most likely sport 3Dfx versions as well. Conversely, not all of these games will be compatible with the 3D Rave protocol used by ATI and Apple—Bungie's upcoming Myth: The Fallen Lords, for example, supports only 3Dfx-accelerated graphics.

The result of the Power3D's acceleration is nothing short of spectacular. Myth, Quake, and MechWarrior 2 are drop-dead gorgeous when played with the Power3D installed. Previously pixelated textures are smoothed, water undulates, smoke and haze take on transparency, and shadows become far more realistic. What's more, the card delivers all this at high frame rates. On a Power Computing PowerTower 180e, the Power3D running the 3Dfx version of

Quake attained 28.2 fps at full-screen, 640-by-480-pixel resolution, compared to 9.7 fps produced by the ATI Xclaim VR running the 3D Rave version of the game.

The Power3D comes bundled with full versions of Bungie's Weekend Warrior, Activision's MechWarrior 2, and VR Sports's VR Soccer; episode 1 of Quake is also included. The only thing missing from the Power3D box is the 32MB of RAM you're going to need.

Alas, the Power3D isn't compatible with many non-multisync monitors. The card has a locked, 60MHz refresh rate, and if your fixed-rate monitor can't adjust to this rate, you're out of luck. TechWorks claims to be working on this problem.

**Macworld's Buying Advice** Although the Power3D is a one-trick pony, the trick it performs—3-D acceleration for games—is done extremely well. If you're serious about 3-D gaming on the Mac, this is the card to have.—CHRISTOPHER BREEN

**RATING:** ★★★★★/8.2 **PROS:** Produces beautifully rendered 3-D images; increases frame rate; good game bundle. **CONS:** Stiff RAM requirement; incompatible with many non-multisync monitors. **COMPANY:** TechWorks (512/794-8533, www.techworks.com). **LIST PRICE:** \$249.95.

# Ready for the Millennium

The way IT buyers shop  
for computer products  
is about to change.



**WebShopper**™ [webshopper.com](http://webshopper.com)



# ONE PLANET. ONE CHANCE. TAKE IT BEFORE THEY DO.



# DEADLOCK™

## PLANETARY CONQUEST



SIX RACES COLONIZE A VIRGIN PLANET. ONLY ONE WILL SURVIVE. BUILD YOUR PROVINCE'S STRUCTURES. CONDUCT RESEARCH TO ADVANCE YOUR RACE. DEVISE THE PERFECT STRATEGY OF DIPLOMACY, INTIMIDATION AND WARFARE TO ENSURE YOUR SURVIVAL. PLAY AGAINST THE COMPUTER OR A LIVE OPPONENT IN THIS INNOVATIVE TURN-BASED STRATEGY GAME.

"Absorbing Gameplay"  
-Next Generation

"Deep, rich...one of the best  
conquer-the-planet strategy games  
in years. Editor's Choice"  
-PC Gamer

"Sim City on Steroids"  
-Computer Life

**800-229-2714**

Call for a free catalog or visit our  
website at [www.wizworks.com](http://www.wizworks.com)

**ACCOLADE**



"...richly developed backgrounds of the alien races and the thoroughly  
refined technology give this game a personality all its own."

-Computer Gaming World

**MacSoft®**

An Affiliate of GT Interactive Software  
2300 Berkshire Lane, Plymouth, MN 55441 612.509.7600

Deadlock is a trademark of Accolade, Inc. Apple, Macintosh, and MacOS are registered trademarks of Apple Computer, Inc. All other product names are of their respective owners. Published under license by Accolade, Inc. ©1997 Accolade, Inc. All rights reserved.

Circle 29 on reader service card



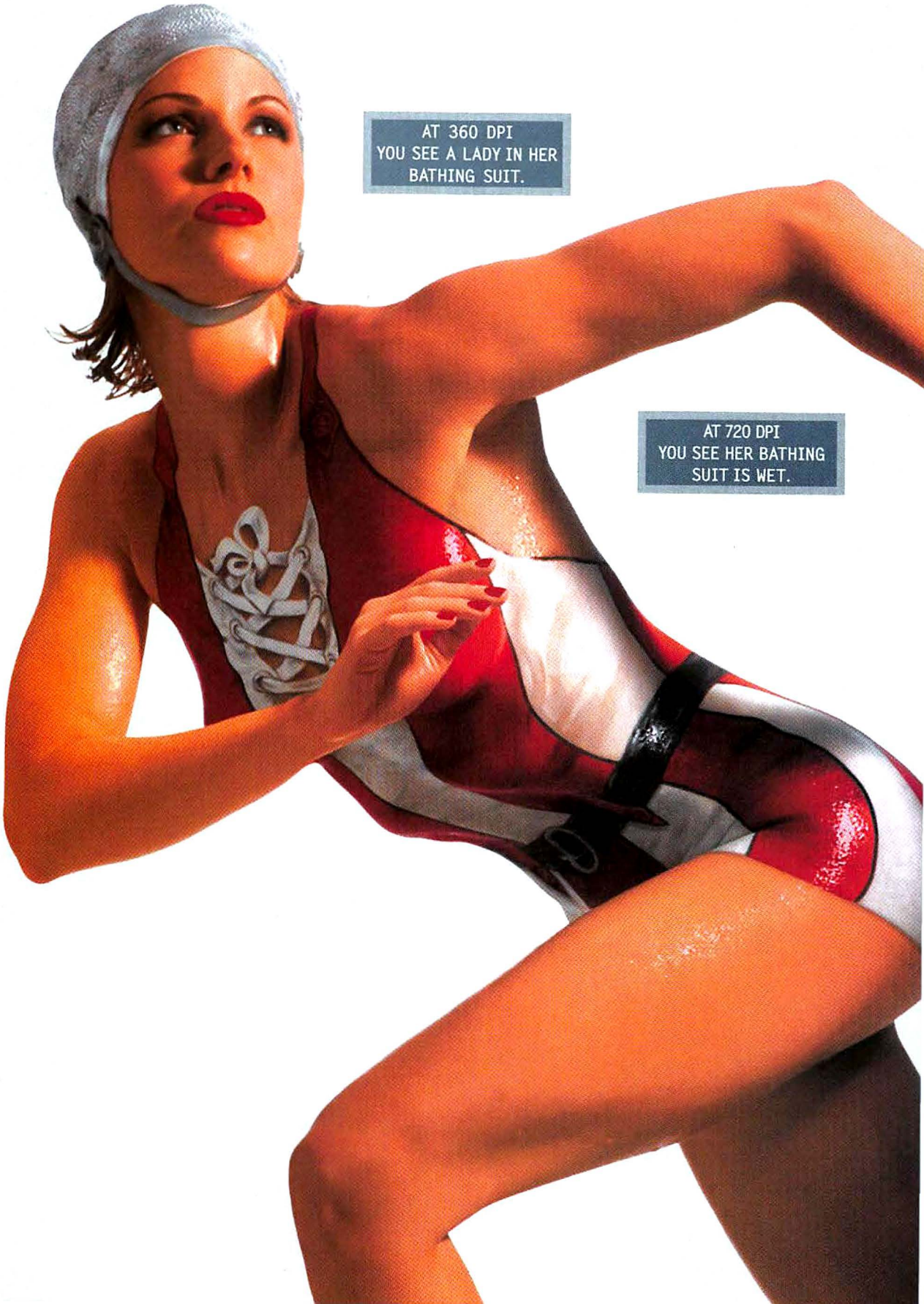

AT 360 DPI  
YOU SEE A LADY IN HER  
BATHING SUIT.

AT 720 DPI  
YOU SEE HER BATHING  
SUIT IS WET.



YOU'VE GOT TO SEE IT IN

**EPSON**

COLOR.



AT 1440 DPI  
YOU SEE HER BATHING  
SUIT IS PAINTED ON.



An amazing paint job makes you think it's a bathing suit. These astonishing new printers let you know it's not. 1440 x 720 dpi—for incredible detail. Micro Piezo™ Technology—for a smaller, more consistent dot. All from our exclusive PerfectPicture™ Imaging System. You'll get Photo Quality color and laser-sharp black text—print quality that's already won 39 major awards, including PC Computing's 5 Star Rating. In standard format or wide format. PC/Mac compatibility. Optional internal Ethernet. Up to 8 ppm black/7 ppm color on the EPSON Stylus® Color 800. Plus a 2-year warranty. Call 1-800-GO-EPSON (ask for operator 3010) or visit us at [www.epson.com](http://www.epson.com) for more details. For every detail, look at the output.

**INTRODUCING THE WORLD'S FIRST 1440 DPI  
COLOR INK JET PRINTERS.**



EPSON Stylus® Color 800. High-performance business printer.

EPSON Stylus® Color 1520. The versatile wide-format printer.



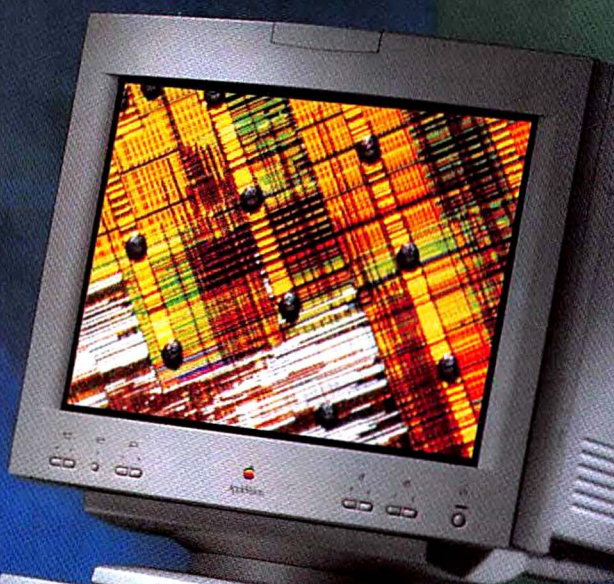

**New Performance Champs** Apple's newest Macs—the Power Mac G3 266 tower, the Power Mac G3 233 desktop, and the PowerBook G3 250 notebook—bring both speed and value to the Mac community.



PowerPC 750  
Debuts at an  
Amazing Price

# Apple's Next-Generation Systems

IF YOU THOUGHT THE DAYS OF LOW-COST, fast Macs died when Apple Computer killed off licensing of the Mac OS, think again. Apple has picked up the torch and is moving forward with a new architecture that drops fast Macs into the low-cost market. In fact, Apple's new Macs are so affordable that they are only a few hundred dollars more than Apple's budget Power Mac 6500/250, which offers half the speed of the new systems. Coming from Apple, such high performance with such a low price tag is simply amazing.

The new Power Mac G3 series is Apple's latest response to users' constant requests for affordable Macs. In fact, these bargain Macs are the first sign that Apple is trying to deliver on its overdue vow of inexpensive top performers.

by Allyson Bates

Starting as low as \$1,999, the Power Mac G3s promise high performance with economical upgrade options. This translates into Macs with quick system buses, low-cost upgrades, faster hard drives, and overall increased performance. And if *Macworld's* first look at Apple's Power Macintosh G3 line is any indication, there are some great deals to be had. Apple expects to have the final systems available by the time you read this; we looked at prototype units.

How did Apple answer our prayers for low-cost, fast Macs? It streamlined manufacturing to cut in-house costs by standardizing on one motherboard design for all three Power Mac G3 models and creating *personality cards* for specific models. These cards contain multiple functions that would otherwise have to be on the motherboard, which would result in different motherboards for different models.

In a welcome change of pace for Apple's systems, the prices for the new Power Macintosh G3s come close to those of the competitive PC market. A comparably configured, MMX Pentium-based Dell Optiplex GN+ 233 PC costs \$2,182 (including a 15-inch monitor), compared to a 233MHz Power Mac G3 with monitor's \$2,350 price—and we expect the Power Mac G3 line to perform noticeably better than MMX Pentium-based PCs at the same megahertz rating.

Still, PCs are only getting cheaper: At press



time, NEC Technologies announced a 300MHz Pentium II-based system, the Direction SPL3000, for \$2,298, including a monitor and a Zip drive. A comparably equipped Power Mac G3 266 tower will cost about \$3,500 and likely will be no faster than the NEC system.

**Limited Configurations**

Apple plans to have only three Power Mac G3 configurations at release. Apple will offer two desktop models and one tower configuration—a \$1,999 233MHz desktop, a \$2,399 266MHz desktop, and a \$2,999 266MHz tower.

All systems use the new PowerPC 750 (widely known by its code name, G3) and sport a 512K secondary cache, a 66MHz system bus (old news in the PC market), 32MB of RAM (using the fast synchronous dynamic RAM, or SDRAM, that PCs started using last year), and 2MB (upgradable only to 6MB) of video RAM.

The 266MHz tower features a larger, 6GB IDE hard drive (instead of the 4GB desktop version) and more AV capabilities, including video in/out and a DAV (Digital Audio Video) connector. Apple introduced the DAV connector in the Quadra 840AV five years ago, but this attempt to create a special-purpose bus for motion video has not resulted in any appreciable number of DAV products, even though Apple has kept the DAV technology in various Power Mac lines.

Don't be too disappointed if you expected to see faster-megahertz systems from this product line. It's likely that we'll see even speedier CPUs in the future, since Mac licensees Power Computing and Motorola Computer Group announced 266MHz, 275MHz, and 300MHz 750-based systems in August, which they canceled when Apple killed licensing of the Mac OS.

And while you may be pleased that these initial systems are much cheaper than the projected prices for the defunct 750-based clone Macs, you shouldn't expect the same accelerated performance or cross-platform compatibility (such as support for PC peripherals using parallel and PS/2 connectors) that the killed systems would have offered.

**Pushing the Limits**

When we put these speed demons to the test, Macworld Lab got some interesting results. The 266MHz tower ranked the highest of all three configurations, with a

mighty 4.5 SpeedMark score—higher than that of the much more expensive 350MHz Power Mac 9600/350, which uses the PowerPC 604e. (The 9600/350 is in such short supply that Apple has stopped taking orders for it. Only a few systems had been sold.)

The 9600 models do have more memory slots and PCI slots, but whether that's worth a \$2,000 price difference remains to be seen.

**Where the Speed Comes From**

Apple improved several components to get the high speed from its new mainstay Mac models.

**Faster System Bus** Shortened bus lengths on the smaller motherboard let Apple increase the system bus speed from 50MHz to 66MHz, since there's less possibility of signal degradation. A faster bus means that all components are communicating with one another more quickly.

**Backside Cache** The PowerPC 750 uses a different caching scheme than previous PowerPCs do. It has a special bus that connects the cache directly to the CPU (this scheme is called a backside cache), rather than going through the system bus, so data can move more quickly between the CPU and the cache. Plus, the connection between the cache bus and the PowerPC 750 runs at twice the speed of the system bus (a 2:1 ratio). That means a 133MHz connection for the 266MHz Power Mac G3s and 117MHz for the 233MHz model. Compare those with the 40MHz to 50MHz connections in previous Apple Macs.

Current Power Mac models are configured with a 512K backside cache, but Apple is considering bundling 1MB and possibly increasing the backside cache to a 1:1 ratio, which would have the cache bus run at the PowerPC 750's full 266MHz. Both techniques would signifi-

cantly boost speed over the present 512K configuration. For more details on backside-cache technology, see "275MHz Mac Powerhouse," September 1997, and "Upstart Macs," October 1997.

**Memory Controller** In addition, Apple has programmed the memory controller/PCI bridge, which traditionally accesses only one function at a time, to take on multiple tasks. Therefore, instead of only being able to send single commands to the backside cache, the memory controller can now dictate one function while performing other duties.

**A More Upgradable Mac**

Apple's new motherboard design, as well as some other design decisions, make the Power Mac G3 series one of the most easily upgraded Mac series Apple has ever offered.

**Easier Access** The motherboard's compact design (see the sidebar "Inside Apple's New Motherboard")—based on the PC-standard size known as ATX—let Apple move the hard drive in the desktop models, freeing up an extra drive bay (there are now two, versus the 7300's one). And the board's clean design allows easy memory and PCI-card upgrades. The tower's chassis, now more accessible to users, imitates the popular case design of the Power Mac 8600. Easy-to-locate green levers and handles make it simple to maneuver around in the clean interior.

**Removable CPU** Located near the bottom of the motherboard, the removable 233MHz or 266MHz CPU (a first from Apple) fits tightly into a PC-style ZIF (zero insertion force) socket, a convenient maintenance feature that will also allow CPU upgrades if faster CPUs become available. (Umax Computer already uses this approach in its Super-Mac systems.)

**Personality Cards** One of Apple's

**New G3 Macs Call into Question the Value of 9600 and 6500 Models**

	Company's Estimated Price	Speed-Mark	CPU TYPE			CPU Speed
			750	604e	603e	
Power Macintosh 9600/300	\$3,799	4.3		●		300MHz
▶Power Macintosh G3 266MHz tower prototype	\$2,999	4.5	●			266MHz
Power Macintosh 6500/300	\$2,999	2.5			●	300MHz
Power Macintosh 6500/275	\$2,499**	2.4			●	275MHz
▶Power Macintosh G3 266MHz desktop prototype	\$2,399	NA	●			266MHz
▶Power Macintosh G3 233MHz desktop prototype	\$1,999	4.0	●			233MHz
Power Macintosh 6500/250	\$1,999	2.2			●	250MHz

NA = not available. ▶ Indicates new system. \*\*Macworld Lab's SpeedMark test compares different systems' real-world application performance.



# New Power Mac G3 Series Offers Solid Speed Boost

The new Power Mac G3 systems, when they ship in November, will bring top-level performance at midlevel prices. The new systems cost about \$2,000 less than the faster PowerPC 750-based systems that Motorola and Power Computing had planned to ship but canceled when Apple rescinded Mac OS licensing. The new Apple systems match existing Apple models that cost much more, such as the 9600 series, and they vastly outperform comparably priced entry-level systems such as the Power Mac 6500/250. These new systems show that Apple has heard the price message and has gotten much of the performance message. Note that Apple was unable to provide a prototype 266MHz Power Mac G3 desktop system for testing.

■ Best overall performance. Longer bars are better. Bold indicates best results in a specific test. ▶ New system. An Apple Power Macintosh 7100/80 has a SpeedMark score of 1.0.



## Behind Our Tests

The Apple G3 systems were running Mac OS 8. All other systems were running System 7.6.1.—Macworld Lab testing supervised by Jeffy Milstead

most innovative but frustrating ideas for the G3 line is the use of personality cards. Combining similar functions onto one riser card was one of several suggestions *Macworld* made to Apple that have found their way into these newest systems—a 66MHz bus, SDRAM, and an integrated CPU and cache card were three others; see “The Mac Reborn,” September 1996.

In that article, we proposed combining communications features (modem, Ethernet, and ISDN) on one card. Now, over a year later, Apple has taken the idea one step further by grouping 16-bit stereo in/out and a K56flex 56-Kbps modem on a single personality card that latches into the new, proprietary personality connector. This card is standard on the two desktop Power Mac G3s. (Apple expects a

software upgrade this spring that will update the modem's proprietary K56flex protocol into the final public 56-Kbps protocol now being developed.)

In the 266MHz Power Mac G3 tower, Apple adds AV capabilities on the card: 24-bit video in/output, a TV tuner connector, and a DAV connector for digital and audio hookup.

With these personality cards, Apple saves on production costs by making a single motherboard and adding appropriate cards. For you and me, however, the benefits are not as clear, since you can't buy personality cards with the options you want. For example, the AV personality card is available only with the 266MHz tower—you can't buy one for the other Power Mac G3 models. And Apple has

no plans to license the personality cards so other companies can make them. The short of it: These cards won't be available to users as upgrades, from Apple or anyone else.

For the time being, these cards may free up PCI slots, but since you can't buy personality cards with other features, you'll have to start adding PCI cards or external devices to add or upgrade features later. And with only three PCI slots in these new systems, you'll be cramped for space.

## Standard Features

**Expansion Slots** The Power Mac G3 series comes with three PCI slots, as well as the DAV slot in the 266MHz tower. There's also the ZIF socket for upgrading to a faster CPU. For those who want a multiprocessing system, it's not clear if anyone will offer a ZIF-based upgrade, although it's technically possible.

**RAM** The three RAM slots, configured with a total of 32MB of RAM, are upgradable to 192MB in the desktop models. The tower model's six slots allow up to 384MB.

**Video RAM** On the motherboard, an ATI 3D Rage II chip with a 64-bit graphics accelerator chip are included with 2MB of VRAM. However, this card is upgradable to only 6MB, not 8MB.

Bus Speed	Memory	VRAM	Hard Drive	CD-ROM drive	Zip Drive	Ethernet	Modem	Case
50MHz	64MB	8MB	4GB	24x	●	●		tower
66MHz	32MB	2MB	6GB	24x	●	●	●	tower
50MHz	64MB	2MB	6GB	24x	●	●	●	tower
50MHz	32MB	2MB	6GB	24x		●	●	tower-
66MHz	32MB	2MB	4GB	24x		●	●	desktop
66MHz	32MB	2MB	4GB	24x		●	●	desktop
50MHz	32MB	2MB	4GB	24x			●	tower

are relative to those of a Power Macintosh 7100/80, which has a SpeedMark score of 1.0. \*\*Three configurations available.



Bigger isn't always better. Especially when it comes to motherboards. Among the first changes to Apple's motherboard design for a professional-level Mac since the 7500, 8500, and 9500 were introduced more than two years ago, the most noticeable is its size.

The mini-ATX board, at about the size of a sheet of paper, takes up less room inside the box. It's 36 percent smaller, for example, than the Power Mac 7300's motherboard. Because the board takes less room in the case, the hard drive's location drops to the base of the unit, which means more room in desktop cases for another device such as a Zip drive or an extra hard drive. Although this form factor is new to Apple Macs, the Mac OS licensees have been using the ATX form for over a year now and PC manufacturers have been using it for at least two years.

But what's not so visible is what's really significant. That smaller motherboard is a new design, one that has fewer layers of circuitry and shorter bus lengths, which together result in greater performance and lower manufacturing costs.

The removable CPU is also a combination of values: The ZIF socket is cheaper to make and means easier upgrades. These CPU sockets are a first for Apple but have been in the PC arena for over five years, before the first Pentium CPU. Moreover, Umax started using ZIF sockets with the introduction of its SuperMac C series last year.

## A Fresh Design

Apple's new motherboard design adds more speed and upgrades by using both new and enhanced technologies.

**Smaller Motherboard** The compact, clean design of the mini-ATX motherboard makes upgrading easier by moving slots to more convenient locations. It also helps open more space in the system's case for other components.

## Personality Connector

Apple's proprietary personality cards latch into this new slot to provide communications and sound functions, as well as AV functions in the 266MHz tower.

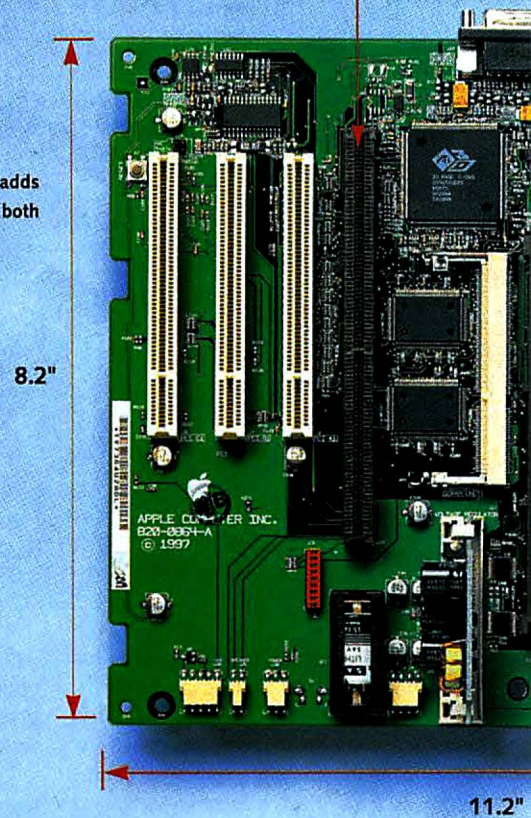

**Storage** The 233MHz and 266MHz Power Mac G3 desktop models include a 4GB IDE hard drive and a 24x CD-ROM drive, leaving two free externally accessible drive bays.

The 266MHz tower version has all the bells and whistles of the desktop models plus a 6GB hard drive, a Zip drive, and one free 5.25-inch bay.

In all three models, the use of IDE drives keeps costs down but also slows drive performance compared to that of the SCSI drives standard in most professional-level Macs.

**Ports** As expected, Apple includes the traditional ports: 10BaseT Ethernet, two serial ports, an ADB port, the standard audio connectors, a Mac monitor port, and a SCSI-2 port. Note that the modem

serial port is deactivated by the modem card that's on the personality card.

## An Architecture with a Past

The architecture that underlies the new Power Mac G3 series, known as CHRP (Common Hardware Reference Platform), is nothing new to the Mac market. Mac OS licensees, such as Power Computing and Motorola Computer Group, developed these Macs and for several months campaigned to get them on the shelves. But as these systems, such as Motorola's StarMax 6000 and Power Computing's PowerTower Pro G3/275, slowly inched their way to the production line, Apple yanked them off.

Apple itself had championed the platform for three years as the way to achieve

lower prices (by using PC-standard parts), more flexibility (by letting owners use PC and Mac peripherals), and more variety (by letting clone makers create their own Mac designs, not just use Apple's). While Apple no longer mentions CHRP, the technology lives on in abridged form in the Power Mac G3 series, delivering on CHRP's first goal: lower cost. Thanks to the remaining CHRP underpinnings, Apple's Power Mac G3s offer very high performance at unexpectedly low prices.

**Abridged PC Compatibility** Unlike the PowerTower Pro G3/275 and StarMax 6000 prototypes we looked at several months ago (see "Upstart Macs," October 1997), the Power Mac G3 series lacks some crucial aspects of CHRP. To our disappointment, the Power Mac G3s lack a



**SDRAM Slots** With the Power Mac G3s, Apple has brought to the Mac fast synchronous dynamic RAM (SDRAM), which fits into these three DIMM slots.

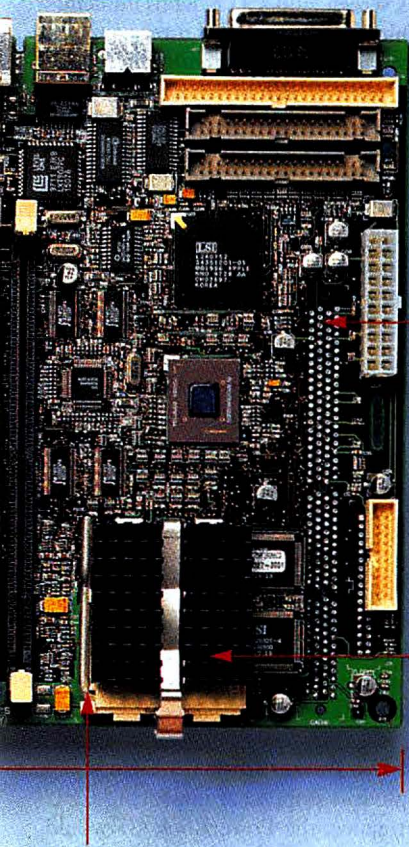

**Backside Cache** A new caching technique, known as backside cache, offers a substantial power boost by using a high-speed bus to connect the PowerPC 750 directly to the cache, moving data more quickly between the CPU and the cache.

**PowerPC 750** This CPU, optimized for Mac business and graphics applications, provides a substantial speed boost over the 601, 603e, and 604e CPUs.

**ZIF Socket** Using a PC-style ZIF (zero insertion force) socket lets Apple keep costs down and saves space inside the case. Long used in the PC world, the ZIF socket will also make upgrades easier and less expensive.

parallel port, PS/2 serial ports, and a VGA monitor port—established CHRP standards. (A VGA port is now standard on Apple's new PowerBook G3.) Without a parallel port, low-cost printer options are still restricted. PS/2-style serial ports would let Mac users buy wireless keyboards and mice. Motorola's now defunct CHRP system had all these features.

**Component Inflexibility** The advantages to using industry-standard features are clear: Using common components decreases the system's overall cost and makes individual components more readily accessible to users.

Apple has implemented the first advantage but not the second. Although users can get components such as RAM and IDE drives from stores across Amer-

ica for do-it-yourself upgrades, they won't be able to get Apple or its dealers to custom-configure their Macs with different options from these readily available components—you're still restricted to what Apple decides to offer.

### Three Kinds of Macs

For two years, Apple has been saying that it is going to streamline its product offerings. That's finally going to happen. Apple feels so confident about these Power Mac G3s that it intends to streamline all its Macs into just three product lines: the Power Macintosh G3 series; the high-end Power Macintosh 9600s (the 300MHz and 350MHz models will survive; lower-speed ones have been dropped); and the education-oriented, all-

in-one Power Macintosh 5500.

Over the next several months, you'll see the Power Mac 7300 and 8600 series disappear as the Power Mac G3s bask in the spotlight. The Power Mac 4400 and 6500 series won't vanish as quickly, but eventually the new G3 systems will trickle into the small-office and home market as well. Take note: With the \$1,999 233MHz Power Mac G3s entering the market at about the same price as the Power Mac 6500/250s, the latter may be gone sooner than you think. Expect fire-sale prices as dealers clear out their inventory of these now-slow systems.

### The Last Word

We can all breathe a collective sigh of relief. With the future of the Macintosh in such a confused state for the last few years, it's comforting to finally see new systems that cater more to users' needs.

Still, it's unsettling to realize that, although these systems provide lower costs and greater performance bumps, Apple's Power Macintosh G3s are not the innovative new systems we had hoped for. No speed records were shattered, as with Apple's new notebook (see the article "Fastest Laptop Yet"). No PC technologies were implemented to broaden our peripheral options. And no new ingenious technologies were developed over what Mac OS licensees had already done: smaller ATX motherboards, removable ZIF CPUs, faster cache architectures, and the PowerPC 750.

Apple effectively slashed the prices of the Power Mac G3s by using a streamlined motherboard design, personality cards, and cheaper components. Unfortunately, it cut some corners too close in doing so: Apple should let other vendors make personality cards, and it should use faster IDE or SCSI drives.

The new Power Macintosh G3 line is a welcome, but not complete, addition to the Mac platform. Apple has successfully started to address its price/performance deficit but has yet to reclaim its position as a computing innovator. Still, low-cost industry-standard components and superfast CPUs move these Macs to the forefront—the first step to making the Macintosh market more accessible to its devoted users. ■

Associate editor ALLYSON BATES used to cover all Mac vendors but now focuses her energies on Apple.



# Fastest Laptop Yet

**Macworld**  
LAB TEST

## New PowerBook Retakes the Lead

by Henry Bortman

Less than a year ago, Apple lay claim to the world's fastest notebook with its PowerBook 3400c/240, creating a sorely needed victory in the Mac/PC wars. Nine months later, the 3400c's speed is not so impressive, given the rash of fast Pentium notebooks that debuted in the summer. So Apple has struck back, producing the new PowerBook G3, which, according to Macworld Lab tests of a prototype, is twice as fast as a 3400c/240 and faster in most tests than a 233MHz MMX Pentium-based PC notebook. The result is a Mac notebook that again lays claim to being the world's fastest notebook.

And Apple's done this for about \$5,700—\$800 less than the 3400c/240 cost when it debuted. (The 3400c/240 now costs \$4,500; the 3400c/200, \$3,800; and the 3400c/180, \$3,200.)

That's the good news. The bad news is that Apple has carried over several flaws and undistinguished aspects of the 3400c.

### A Precocious PowerPC

The most important speed enhancement is the PowerBook G3's CPU, the PowerPC 750, the CPU used in the new Power Mac G3 desktop and tower systems.

**The 750 Advantage** Given that the PowerBook's CPU runs at 250MHz, a clock speed only a shade higher than that of the 240MHz CPU in the PowerBook 3400c/240, why is the PowerBook G3 so much faster? The answer is that the PowerPC 750 is a much faster chip, megahertz for megahertz, than the 603e that lies at the heart of the 3400c.

**A Better Bus** The PowerBook G3 has another advantage over the 3400c/240, by virtue of its faster system bus: 50MHz versus the 3400c/240 bus's 40MHz. The faster the system bus, the less time the CPU has to sit idle waiting for data to arrive from memory.

The PowerPC 750 incorporates what's known as a backside cache, which

lets the CPU access data stored in the cache at 100MHz, twice the rate of the PowerBook G3's system bus. Compare that with the 40MHz cache speed of the PowerBook 3400c/240. Plus, the PowerBook G3 has a larger cache—512K versus 256K in the 3400c/240—which means it can handle more calculations too.

**Performance Leap** These factors—a faster CPU, a faster system bus, and an improved cache—add up to an eye-popping 71 percent speed increase in Macworld Lab's CPU-intensive suite of tests.

What this means to you is that the PowerBook G3 can beat out all but the fastest desktop systems available. Team up this new notebook with a high-resolution digital camera, and you'd have a combination that would give a professional photojournalist little to complain about.

**Versus Pentium Portables** It's all well and good to compare Apples to Apples, but how does the PowerBook G3 stack up against a top-flight PC notebook? To find out, Macworld Lab compared a PowerBook G3 with one of the fastest PC notebooks, the Gateway 2000 Solo 2300XL (800/846-4208, [www.gateway.com](http://www.gateway.com)).

The Solo 2300XL has a 233MHz MMX Pentium CPU, 32MB of RAM, a 256K cache, a 3GB hard drive, a 10x CD-ROM drive, a removable-storage bay, 2MB of video RAM, a 12.1-inch active-matrix screen, and a 33.6-Kbps modem.

Our test suite included three common Photoshop tasks, a 3-D render in Macromedia Infini-D, and two Microsoft Word tasks. The winner in almost every test was the PowerBook G3. On our Photoshop tests, the PowerBook beat the Solo by between 30 and 43 percent. The PowerBook did even better on the floating-point-intensive 3-D-rendering test. And its speedy graphics chip showed its advantage in our Word scrolling test.

The only test in which the Solo 2300XL bested the PowerBook G3 was the Word find-and-replace test. This just goes to prove that even a screaming-fast PowerPC CPU can't always overcome the engineering effort Microsoft expends to guarantee that its Windows apps outperform their Mac-based cousins.

On the other hand, the Gateway 2000 notebook costs only \$3,799, nearly \$2,000 less than the PowerBook G3—and \$700 less, in fact, than the recently price-reduced 3400c/240.

### What the PowerBook G3 Offers

If Apple had stopped at improving CPU performance, the PowerBook G3 would still have been a winner. But Apple didn't.

**More RAM** Apple has bumped up the

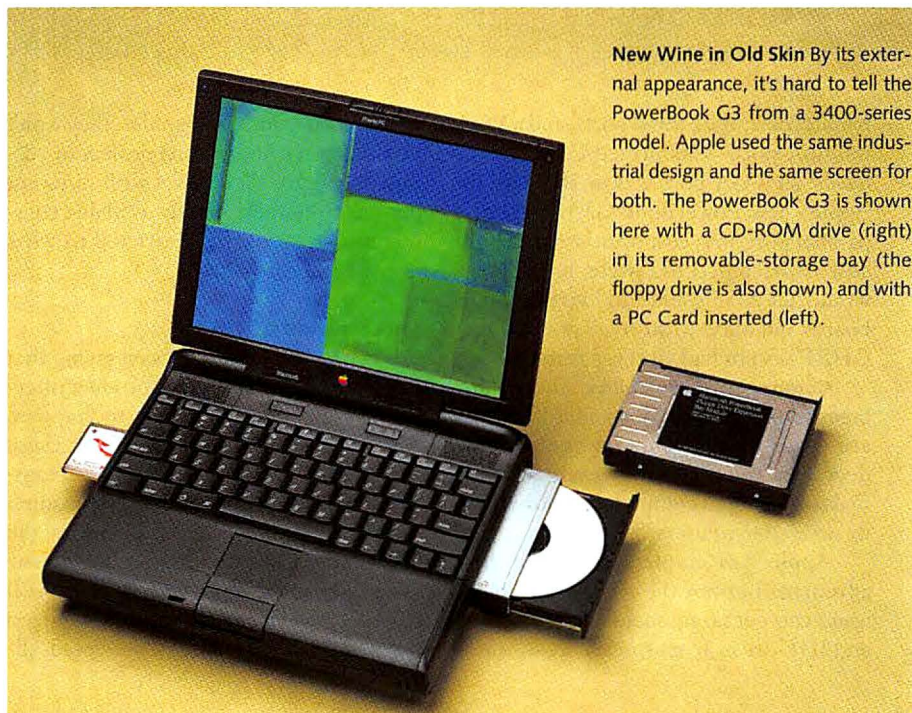

**New Wine in Old Skin** By its external appearance, it's hard to tell the PowerBook G3 from a 3400-series model. Apple used the same industrial design and the same screen for both. The PowerBook G3 is shown here with a CD-ROM drive (right) in its removable-storage bay (the floppy drive is also shown) and with a PC Card inserted (left).



# The PowerBook's Incredible Performance Leap

The PowerBook G3 represents an astonishing leap forward in speed. While admittedly not as fast as Apple's new Power Mac G3 systems, it leaves Apple's former top-performing PowerBook, the PowerBook 3400c/240, in the dust. Apple has made improvements in nearly every area affecting PowerBook speed: The PowerBook G3 contains a PowerPC 750 CPU running at 250MHz, a 50MHz system bus, a 512K backside cache (accessed at 100MHz), a high-performance 5GB IDE hard drive, and 2MB of VRAM for graphics display. The result is an unprecedented overall speed improvement of 65 percent over the PowerBook 3400c/240, for only 27 percent more money.

■ Best overall performance. Bold indicates best results in a specific test. ▶ New system. An Apple Power Macintosh 7100/80 has a SpeedMark score of 1.0; longer bars are better. Mac versus PC results are in seconds; lower times are better.

## The Fastest Notebook Mac . . .

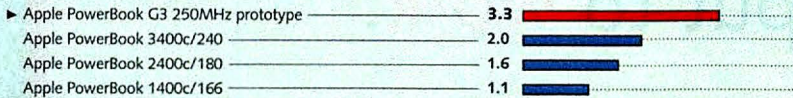

## SpeedMark

CPU	FPU	Disk	Video	Star Rating
<b>3.6</b>	<b>3.6</b>	<b>2.2</b>	<b>4.0</b>	not shipping
2.1	2.1	1.6	2.3	★★★/7.2
1.7	1.7	1.3	2.1	★★★/5.8
1.2	1.2	1.0	1.0	★★★/6.1

## . . . Catches Up to Desktop Systems . . .

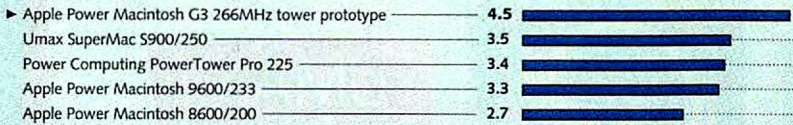

CPU	FPU	Disk	Video	Star Rating
<b>5.0</b>	<b>4.2</b>	<b>3.0</b>	6.9	not shipping
3.8	3.7	2.5	<b>7.3</b>	★★★/6.3
3.6	3.4	2.3	7.2	★★★/6.4
3.5	3.4	2.3	6.9	★★★/6.6
3.0	2.9	1.9	3.6	★★★/6.5

## . . . and Blasts Past Pentium Notebooks

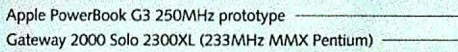

Adobe Photoshop 4.0			MetaCreations Infini-D*	Microsoft Word**	
Convert RGB to CMYK	Unsharp Mask	Rotate to Arbitrary Angle	3-D Render	Scroll Document	Find and Replace
<b>8</b>	<b>14</b>	<b>24</b>	<b>37</b>	<b>30</b>	11
14	20	35	108	69	<b>4</b>

\*Infini-D 4.0 on the Mac and Infini-D 4.1 on the PC. \*\*Word 6.01 on the Mac and Word 97 on the PC.

## Behind Our Tests

All systems were tested with 32MB of RAM. The PowerBook G3 prototype was running Mac OS 8. The PC notebook was running Windows 95.—Macworld Lab testing supervised by Susan Silvius

amount of RAM to 32MB, from 16MB in the 3400c. It's expandable to 160MB.

**Bigger, Faster Drives** The PowerBook G3's hard-disk drive is nearly twice the size of the 3400/240's: 5GB versus 3GB. And the new disk drive is 38 percent faster than its predecessor. You almost never see a jump in drive speed as large as those in CPU speeds; the drive's 38 percent gain is a *major* improvement.

A slow hard drive often negates the speed of a fast CPU, and Apple wisely avoids making that mistake by marrying a fast drive with a fast CPU—something it did not do, strangely enough, with its G3-based desktop systems.

And that extra 2GB provides plenty of room for all those huge presentations, Microsoft Office, and a game or two. You'd be hard-pressed to find a faster or higher-capacity drive for a notebook.

You'll also find a faster CD-ROM drive—20x versus 12x in the 3400c.

**More Video RAM** Apple has upped the VRAM complement from 1MB in the 3400c/240 to 2MB in the PowerBook G3. Smart move. Unfortunately, the Power-

Book G3's VRAM, like the 3400c/240's, isn't upgradable. Dumb move. But 2MB is enough to provide you with 24-bit graphics at up to 832-by-624-pixel resolution and up to 1,024 by 768 pixels at 16-bit color when the PowerBook is connected to an external monitor. (The built-in screen's LCD technology limits its bit depth to 18 bits.) The external-video port is a 9-pin VGA connector, but Apple includes a VGA-to-Mac adapter.

The PowerBook G3's video display is fast—74 percent faster than the 3400c/240's, our tests show. Unfortunately, you still can't run an external monitor as a second monitor, as you can on most other Macs—the PowerBook G3, like the 3400c, can have the external monitor mirror the LCD panel's contents only if the LCD is also active. You also can display to an external 640-by-480-pixel device such as an LCD projector only if you turn off the LCD panel's display—both display devices must work at 800-by-600-pixel resolution for mirroring to work. Finally, you must restart the PowerBook G3 when connecting to an external monitor.

**Other Features** Otherwise, the PowerBook G3 is pretty much the same as a PowerBook 3400c: same boring case, same use of a nonstandard PCI slot, same PC Card slots, same support for Zoomed Video, same 12.1-inch active-matrix LCD screen, same ports (10BaseT Ethernet, high-density SCSI, audio input/output, ADB, and serial), same drive bay, same two-hour battery life, same speakers (with their poor-sounding subwoofer), and basically same weight (7.5 pounds).

## The Last Word

Despite some carryover flaws from the 3400c, this new PowerBook will be the fastest notebook computer anywhere. This is a fully loaded, no-apologies system, able to perform the most-demanding tasks. It truly could function as a desktop replacement. And although it's not priced for the timid, we expect the PowerBook G3 to be worth every penny of the \$5,700 you'll have to shell out for one. **m**

Senior technology editor HENRY BORTMAN uses a PowerBook 1400, but he'd like to upgrade.



## A PARENT'S WISH

"A computer my kids will **learn** from and I can put to **work**."



### C600

The SuperMac C600 line from UMAX is perfect for your educational computing needs.

Choose from a range of quality machines that all deliver high-end performance at a very low cost. With the C600, you can do easy projects such as calendars, newsletters, term papers, greeting cards, and more. All this from UMAX, a company committed to providing the best in customer service and support for Mac OS systems. The SuperMac C600. It's the perfect holiday gift for the office or home.

#### C600vPC/240'

Now you get Windows and Mac capabilities on one powerful machine!

- 240MHz 603e PowerPC Processor
- 3.3GB IDE hard drive
- 24x CD-ROM Drive
- 32MB RAM, 256K L2 Cache
- Stereo Multimedia External Speakers
- CacheDoubler-Ready
- 10Base-T Ethernet
- Connectix Virtual PC (DOS edition) and other software
- Expandable Mini-Tower Case

*Other models and specifications available. Monitor not included.*

For more information on where to purchase the C600, call 1-888-625-UMAX or visit us at <http://www.supermac.com>.



**UMAX**<sup>®</sup>  
Computer Corporation



## THE PRO GRAPHICS WISH

"A machine that handles  
all my big **ideas**."



**UMAX**

MAKES WISHES COME TRUE!

### S900BASE

The S900BASE model combines convenient upgradeability and state-of-the-art engineering—so you can get blazing performance. Here's how the upgrade works: purchase an S900BASE and receive a \$500 discount towards an upgrade with a MAXpowrPRO+ processor card (UMAX edition) from Newer Technology that will make this machine blazing fast. It's an incredible deal!

#### S900BASE

- 150MHz 604 PowerPC Processor
- 64MB interleaved RAM
- 4GB Ultra SCSI hard drive
- 24x SCSI CD-ROM
- 6 PCI slots
- PCI-PCI bridge
- 7 drive bays
- 10Base-T Ethernet
- 8 DIMM slots for upgrade to 1GB memory
- Get the MAXpowrPRO+ upgrade today! See details at [www.supermac.com](http://www.supermac.com).

Monitor not included.

### S900i/250

The popular S900i/250 model supports high-end graphics applications with truly superior performance. This is the most powerful internet-ready workstation on the market—a workstation that, like the Power Mac® 9600, will continue to be upgradeable. With the S900, you're guaranteed the best tools for your creativity.

#### S900i/250

- 250MHz 604e PowerPC Processor
- 64MB interleaved RAM
- 4GB Ultra-wide SCSI hard drive
- 24x SCSI CD-ROM
- 6 PCI slots
- PCI-PCI bridge
- 7 drive bays
- 10/100 Base-T Ethernet
- Internal Zip Drive

Monitor not included.

For more information on where to purchase the S900, call 1-888-625-UMAX or visit us at <http://www.supermac.com>.



PowerPC™



High-Upgradeability

**UMAX**<sup>®</sup>  
Computer Corporation





James

Systems

CD Romms

Fun stuff



# Holiday

# Gift Guide

SNOW FALLS, BELLS RING, CANDLES GLOW, children sing, and shoppers cram into jam-packed malls across the land. 'Tis the season to get whipped into a frenzy in an attempt to find the perfect gifts for friends and loved ones. But if the special people in your life are Mac users, you're in luck. Our crack *Macworld* team has braved the crowds and scoured the catalogs, and we're back with a wish list you won't have to check twice.

For that cousin who's worn out his copy of *Marathon Infinity* and is ready to move on to new challenges, you can't go wrong with the array of amazing software in this year's Game Hall of Fame. If slaying demons or exploring alien worlds doesn't happen to be your friend's cup of tea, then consider our list of *Macworld's* favorite CD-ROMs for kids of all ages.

As you salivate over those Editors' Choice-winning games and CDs, don't let your own

aging Mac get you down. After all, there are more than a dozen speedy new Macs you can buy for less than \$2,000. And the irresistible little extras we've uncovered that are bound to warm any Mac user's heart won't break your budget.

So sit back, put your aching feet up, and forget about the crowds. You've got an edge on all those crazed shoppers. Your little helper is *Macworld's* Holiday Gift Guide.

Great Games.....	page 80
Stellar CDs.....	page 87
Bargain Systems.....	page 93
Irresistible Extras.....	page 98





1998 Game Hall of Fame

# Great Games

GET OUT YOUR JOYSTICKS  
FOR NONSTOP FUN



by Steven Levy and Cameron Crotty

**A**S INDUCTION TIME ROLLS AROUND AT THE MACINTOSH Game Hall of Fame, things as usual are bustling. This is a relief, because—can we be frank here?—this hasn't been the greatest year for the Hall, what with all the uncertainty about, you know, the platform.

But now that our annual gala at the Hall's virtual headquarters in Pittsfield, Massachusetts, approaches, we feel OK. The RSVPs are tumbling in from Internet domains in Cupertino, San Rafael, Hollywood, New York, Tennessee, and Texas. The hoteliers in nearby Lenox report full houses. We expect a banner crowd in our grand ballroom, where one wall now sports a newly painted mural of a pumped-up handshake between Steve Jobs and Bill Gates.

We're hoping Mr. Jobs himself will attend, standing behind our joystick-equipped dais as we have him explain the process by which the Game Hall of Fame chooses its esteemed entrants: A duo of expert curators coolly evaluates the wealth of contenders and makes decisions that, although

subjective, invariably stand the test of history. And then, with no need for a Reality Distortion Field, the Stevester will announce this year's winners: a stellar cast, in and of themselves a reason for optimism. Let the games begin!

## Adventure

RIVEN ★★★★★/8.3

Just as we were closing down our nomination process, a breathless messenger came to the Hall bearing the five-disc set of *Riven*, the long-awaited sequel to *Myst*. For the



**Riven** Don't pause too long to admire the beauty of the *Riven* world—you've got a lot of work ahead as you try to solve your way out.



next 30 hours all activity stopped as we slapped it on the Power Mac and, after a suitable period of slack-jawed admiration at the stunning graphics, immersed ourselves in a follow-up that, for once, actually tops the original in almost every respect.

Of course, those coming to Riven are much wiser than first-time Myst-ers and are familiar with the routines about linking books, arcane codes to operate machinery, and weird chairs that take you to strange places. But the amazing vividness of the graphics, live action, and sound here provides its own novelty. It is unimaginable that anyone captivated by the Miller Brothers' first effort will not want to dive into this new fantasy world.

*Red Orb Entertainment/Brøderbund Software, 415/382-4777, [www.riven.com](http://www.riven.com); \$50.*

## Arcade

GRIDZ ★★★★★/8.8

Territory rules in Gridz 1.0, a maddeningly compelling challenge that requires you to stake out a claim in a Net-Space, a spreadsheetlike battleground. Then you must defend your turf to the death and, hopefully, extend your domain to rule the grid.

It's not an easy endeavor, since both you and your foes (either computer-operated or human tormentors) conduct

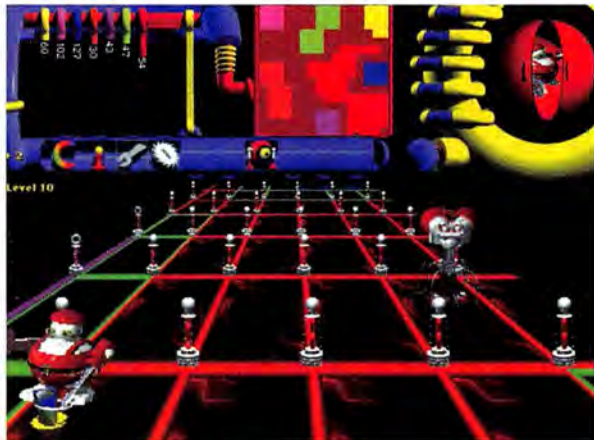

**Gridz** The slightly orange red zone is your empire—in the map on top, note that you've got blue surrounded. In the foreground is a builder robot who's hoping to steal space from the pink zone.

war and real estate by use of accurately described “goofy little robots” designed to claim space, steal space from others, and buzz-saw (even bomb) opposing robots. (Upside: Sometimes it's smart to let others duke it out while you build strength.) Each time you conquer, a higher, trickier level awaits—but you also get points that allow you to buy more exotic 'bots.

Playing Gridz is addictive, plus the fanciful, often hilariously destructive robots are a hoot. And the game's sounds—grinding, beeping, *kabooming*—are not only cool but also crucial in allowing you to identify threats to your 2-D empire.

*Green Dragon Creations, 601/473-4225, [www.greendragon.com](http://www.greendragon.com); \$35.*



**F/A-18 Hornet** Tell the boys on the ground to pull their heads in and button up, because the high heat is on the way, extra pronto.

## Flight Simulator

F/A-18 HORNET ★★★★★/8.8

A perennial contender for the flight category, Graphic Simulations' F/A-18 Hornet has only improved over the years. Version 3.01 breaks through with improved graphics and even more-realistic cockpit-system simulations.

A large part of being a successful pilot is developing “situational awareness,” and while your Hornet feeds you plenty of data, it's up to you to analyze it and act like a real pilot. Whether you're flying against the computer or a real opponent, Graphic Simulations' latest provides quality air time and then some.

*Graphic Simulations, 972/386-7575, [www.graphsim.com](http://www.graphsim.com); \$30.*

## Strategy

CREATURES ★★★★★/7.7

For all the hue and cry about “artificial life”—using computers to create digital beings that actually live, if not breathe—the most fetching organisms to emerge from silicon so far have been those little Tamagotchi things that kids drag around.

Until now, Creatures allows you to hatch little reptilian pets called Norns and raise them as your own, even teaching them language. Virtual parenthood isn't easy. It takes skill, patience, and forbearance—but not private-



**Creatures** It's up to you to train your little creature, or Norn. The hand can either praise (by tickling the nose) or punish (by slapping the butt). Paging Dr. Spock!





**Links LS** There's nothing like a relaxing round of golf. You can almost feel the wind in your face and smell the trees while you listen to your ball crash through the underbrush.

school tuition—to see a Norn through childhood and adolescence and into adulthood. You do have to watch out for the Grendels, who live in trees and carry diseases that could doom your Norn. Although Creatures can draw you in powerfully (maternal/paternal instinct runs deep), be forewarned that after only 15 hours or so, a Norn can die of old age.

*Mindscape Entertainment, 408/737-6800, [www.creatures.mindscape.com](http://www.creatures.mindscape.com); \$40.*

## Action

**DUKE NUKEM 3D: ATOMIC EDITION** ★★★★★/7.0

He's mad, bad, and dangerous to know, but if you're a Mac gamer looking for a serious shot of attitude, Duke Nukem might just be the best friend you've got, pilgrim. With an impressive and entertaining array of weaponry and other fun hardware (we love the JetPak), Duke takes on hordes of invading aliens in level after level of colorful and downright *creepy* surroundings.

Parents and the easily offended should note that Duke Nukem (developed by 3D Realms) is definitely R-rated for both violence and sexual content, but the game's comic tone and addictive action more than make up for the occasional crudity. Load up on the heavy artillery, and let's go get some!

*MacSoft, 612/509-7600, [www.wizworks.com/macsoft](http://www.wizworks.com/macsoft); \$50.*

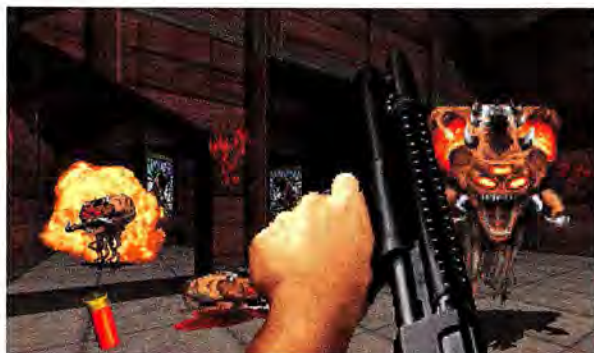

**Duke Nukem 3D** It's always a party when Duke Nukem comes to town. Those evil aliens should know better than to leave high explosives just lying around, shouldn't they?

## Sports

**LINKS LS MACINTOSH** ★★★★★/8.6

Computer sports simulations are always compromises—just check the difference in your heart rate after clicking a mouse and after running 100 yards, and you'll see what I mean. Perhaps because golf is more about finesse than sweat, Links LS manages to capture much of the game's elusive essence. A few moments spent soaking in the lush graphics and background sounds will put you in the mood to adjust your stance, check the wind, and go for the perfect swing. Just remember to hold on to that Zen-like calm after you shank another drive into the hardwoods. Links is, after all, a simulation.

*Access Software, 801/359-2900, [www.accesssoftware.com](http://www.accesssoftware.com); \$50.*

## Kids

**PUTT PUTT TRAVELS THROUGH TIME** ★★★★★/8.7

It's only fitting that the first inductee in this long-overdue category involves an adorable little jalopy named Putt Putt, protagonist in a series of no-reading-necessary adventure games that present a wonderful alternative to the twitch games and the preachy-teachy stuff usually offered to cyber-whippersnappers.



**Putt Putt Travels through Time** Putt Putt meets characters like this grizzled prospector. Hear these buzzards out—you might get something you need.

This is the fourth in a series—previously the Puttmeister has gone on parade, to the moon, and to the zoo—and each journey has been more elaborate than the previous, loaded with fascinating characters and interesting diversions (as well as a catchy soundtrack that lasts longer than the game, which itself lasts for hours).

In this iteration, the plucky little auto has to time-travel to retrieve his belongings; an unfortunate incident involving fireworks has spread them centuries apart, as early as dinosaur days and as late as the Jetson-ion future.

As with the other Putt Putt games, there is a point behind all the jollies: to encourage junior adventurers to master the reasoning and problem-solving skills necessary to complete the task. But the bottom line is fun, and as in grown-up adventures, the journey itself is the reward.

*Humongous Entertainment, 425/486-9258, [www.humongous.com](http://www.humongous.com); \$40.*





**Quake** This MacSoft game showcases developer Id Software's visions of death and destruction, which have always been a little darker and more twisted than most.

## Network

**QUAKE** ★★★★★/8.6

The office clock reads five-oh-oh and—after a long day of mollycoddling incompetents—it's time to kick a little ass. Reach for your copy of Quake 1.08.3 (developed by Id Software), and get ready to light up the network. Quake's realistic 3-D environment delivers unparalleled realism to point-and-kill sessions, but the basic software package is only the tip of the iceberg.

Quake is nearly infinitely customizable and has spawned a huge following. A quick jaunt through the Web will hook you up with new maps, new weapons, and literally hundreds of fellow gamers itching for a Deathmatch. Quake sets a new standard for network gaming.

MacSoft, 612/509-7600, [www.wizworks.com/macsoft/](http://www.wizworks.com/macsoft/); \$50.

## Role Playing

**THE LAST EXPRESS** ★★★★★/8.7

It's *Myst* meets Agatha Christie in this absorbing ride on the Orient Express. Europe is preparing for World War I, but your problem is more immediate: You are Robert Cath, an



**The Last Express** Who knows who you'll meet on the Last Express? Maybe Alexei, a Russian anarchist. Will he punch your ticket?

## HARDWARE

**F-16 FIGHTERSTICK** ★★★★★/8.7

**PRO THROTTLE** ★★★★★/8.4

**F**OR YEARS WE'VE WAXED RHAPSODIC ABOUT THE Macintosh game software, but never before has *Macworld* doffed its hat to the hardware side of the aisle. We couldn't ignore this last year's bumper crop of joysticks, pedals, thumb pads, and other specialized doodads designed to enhance your gaming experience.

With so many worthy candidates, choosing a winner was a tough call—but that's the kind of high-pressure situation Game Hall of Fame curators thrive in. And so we induct CH Products' (760/598-2518, [www.chproducts.com](http://www.chproducts.com)) F-16 Fighterstick (\$120) and Pro Throttle (\$100). Both controllers are solid-feeling and responsive, sport loads of buttons and switches, and come with software that makes configuration a snap.



**One-Two Punch** The Pro Throttle (left) and the F-16 Fighterstick (right), from CH Products, deliver the precision hands-on control that Mac gamers need to stop the bad guys in their tracks.

We would be remiss, however, if we didn't tip our hats to the runners-up: two companies that have been faithfully serving up quality products to Mac gamers for years.

Advanced Gravis Computer Technology (604/431-5020, [www.gravis.com](http://www.gravis.com)) was one of the first companies to fly in the face of tradition and offer game hardware to the Mac community. Its original Mousestick and current Mousestick II (\$60) were like manna from heaven for a generation of Mac game enthusiasts, and it's kept up the pace with several recent new releases—the Firebird (\$90) and the Blackhawk (\$70).

ThrustMaster (503/615-3200, [www.thrustmaster.com](http://www.thrustmaster.com)) deserves credit for being the first company to bring realistic flight-sim hardware to the Mac. Its Flight Control System for Macintosh (\$110) and Weapons Control System for Macintosh (\$75) remain first-class choices for any flight-sim enthusiast.—CAMERON CROTTY



American who boards the venerable train, only to find his buddy dead in compartment one.

What transpires next is an adult-directed murder mystery, rendered in exquisite graphics inspired by Toulouse-Lautrec (eat your hearts out, Doom players) and unfolding in an orderly, brisk progression that keeps you alert while not punishing you for experimenting. (If you do make a fatal error, you can "rewind" the game to the point before which you committed your boo-boo.)

What makes *The Last Express* vividly memorable is the painstaking detail, particularly the lush score and the faith-

fully rendered sounds of the most famous train ever. So while you may never solve this three-disc conundrum, you'll never forget the ride.

Red Orb Entertainment/Brøderbund Software, 415/382-4777, [www.lastexpress.com](http://www.lastexpress.com); \$40. **m**

Veteran Game Hall of Fame curator and *Newsweek* senior editor STEVEN LEVY wrote *Insanely Great: The Life and Times of Macintosh, the Computer that Changed Everything* (Viking, 1994). CAMERON CROTTY, an ex-arcade rat, made his living hustling Tempest until he figured out that he could get paid for writing about computer games.

## COMING ATTRACTIONS

**A** GAMER AND A PROGRAMMER will never be satisfied. The latter always wants to add "just one more thing," while the battle cry of the former is, "That was cool. What's next?"

In the spirit of these two archetypes, the curators of the Game Hall of Fame this year encouraged companies to let us see their best stuff, even if it wasn't quite finished. A game can be considered for induction only if it ships before our deadline, but here's the inside dope on a couple of contenders for next year—which should be out for the holidays. —CAMERON CROTTY

### **Myth: The Fallen Lords**

In the fantasy vein, Bungie Software (312/563-6200, [www.bungie.com](http://www.bungie.com)) is busy pushing the envelope of real-time strategy games with its much anticipated *Myth: The Fallen Lords*. *Fallen Lords* (\$49) focuses intensely on battlefield tactics: You direct the actions

of natural and supernatural troops in a real-time 3-D environment while circling over the entire field of combat from a god's-eye view. Early returns on time spent in the command chair are extremely positive—this will be a network game to watch out for.

### **Diablo**

Mac gamers who have been looking longingly over their friends' shoulders at Blizzard Entertainment's (714/955-0283, [www.blizzard.com](http://www.blizzard.com)) action/role-playing PC hit *Diablo* now have reason to rejoice: We've played betas, and the Dungeons and Dragons-style game is nothing short of awesome. *Diablo* (\$50) eschews the first-person point of view in favor of a top-down three-quarter view in a 3-D environment. The graphics are beautiful, the game play is exciting and intriguing, and we have to finish writing this fast because we want to play more right now!



**Battle Plan** Directing an army in combat in a swamp in the rain isn't an abstract exercise in *Myth: The Fallen Lords*.



**Clobberin' Time** In *Diablo*, going face-to-face with a rabid pack of Blood Knights is all in a day's work for your basic adventure-some heroic types.



network

need a little

# PICK-ME-UP?

CALL DR. FARALLON<sup>SM</sup> FOR A FREE PRESCRIPTION OF **SPEED**. AND YES—IT'S LEGAL!



*Speed* is absolutely essential in today's fast-paced business world. With file sizes growing and speed-intensive applications running constantly, your network will no doubt have a little congestion. When the over-the-counter remedies are no longer enough, you might need the advice of an expert. Leave the diagnosis to **Dr. Farallon**. No matter what kind of network you're running, Dr. Farallon can prescribe the remedy you need to increase productivity and profitability.

#### *Send Your Files S.T.A.T.*

If your file transfers across the network are slow and time-consuming, **Timbuktu<sup>®</sup> Express** is the remedy for you. Designed to run on any network, Timbuktu Express is file acceleration software that will dramatically increase your network's performance by as much as 450%. So give your files the kick-start they need to get moving at their highest potential.

#### *By-pass Network Slowdowns*

Improving performance on your existing Ethernet network can be easily achieved with a **Starlet<sup>®</sup> Switch** from Farallon. By broadcasting traffic only to the designated segment of your network, the Starlet Switch can drastically reduce traffic, thereby increasing overall network performance.

For sending files over a wide area network connection to clients or service bureaus, be sure to ask Dr. Farallon about our **Netopia<sup>™</sup>** family of ISDN, Frame Relay, Fractional T1 and T1 Internet Routers.

#### *Speed Your Way To Recovery*

If your network is clogged from too many large files, Fast Ethernet is the answer. With 10 times the bandwidth of traditional 10Base-T Ethernet, **Farallon's Fast Ethernet cards, hubs and switches** will have your file transfers moving at top speed in no time.

So to cure your network performance maladies, call Dr. Farallon to receive a FREE diagnosis and prescription for a customized treatment.

**Schedule your FREE network check-up today by calling, 1-800-613-4954. For more information, visit [www.farallon.com/dr.farallon](http://www.farallon.com/dr.farallon)**

*Network specialists are standing by.*

**Farallon<sup>®</sup>**



PanaSync™ S70

PanaSync™ S21

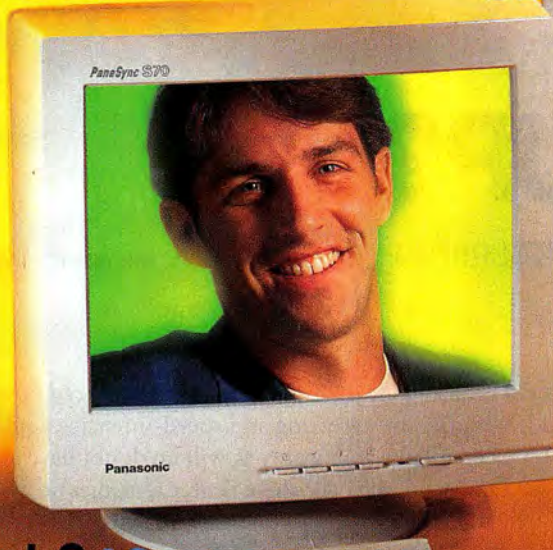

PanaSync™ S15

PanaSync™ LC40

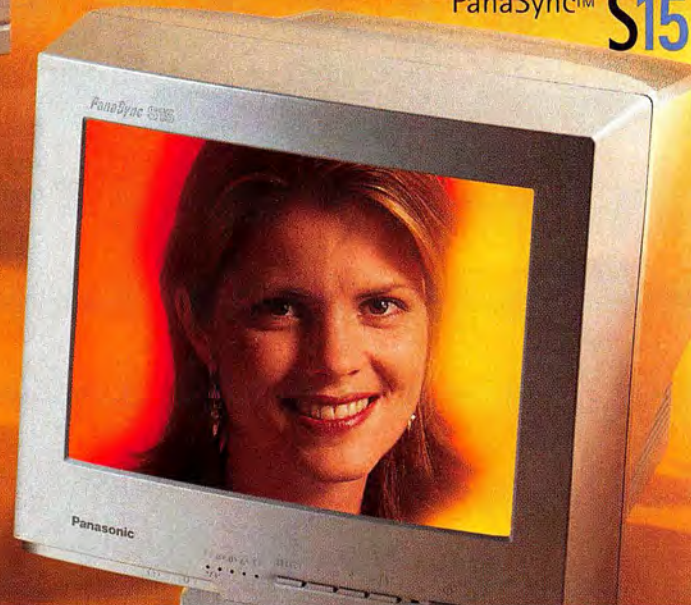
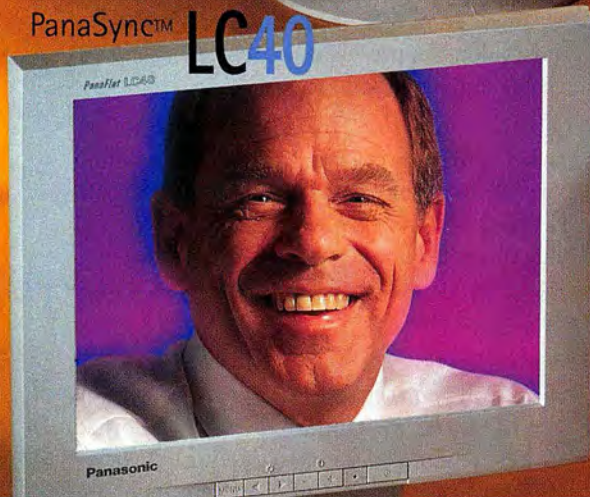

# what WORKS for you?

**PERFORMANCE. RELIABILITY. VALUE.**

Panasonic PanaSync™ monitors give you exactly what you need to get the job done. Our monitors have been designed with today's business environment in mind. If you're looking for a solid, feature rich monitor, try our S15, S70 or S21— ready for virtually any application. If you're looking for a space saving

Liquid Crystal Display, take a look at our LC40, it's an amazing achievement. With a full screen display measuring less than 3" deep, it features a sharp, brilliant picture. And when it comes to performance and affordability we've set a new industry standard.

Model	S15	S70	S21	LC40
Dot Pitch (mm)	0.27	0.27	0.27	0.2775
Max. Res. NI (H X V)	1280 X 1024	1280 X 1024	1600 X 1280	1024 X 768
H-Scan (kHz)	30 - 67	30 - 70	30 - 95	30 - 61
Viewable Area	13.7"	16.0"	20.0"	14.0"

And if you're concerned about customer support, take a look at our program— it's the most extensive warranty and customer support program in the

industry. Our 3-Year Limited Warranty on parts, labor and the CRT, 1-Year On-Site Exchange Program, and 24-Hour, 7-Day Customer Support Hotline, all at no additional cost, adds value you won't get from the competition.

So take a look at the PanaSync™ Series designed for today's business and put one to work for you today.



MN19-MCW

1-800-742-8086 ext. MN19 [www.panasonic.com/alive](http://www.panasonic.com/alive)

Circle 60 on reader service card



by Wendy Sharp



# Stellar CDs

## FIND A GIFT FOR EVERYONE ON YOUR LIST

**T**IS THE SEASON TO SEEK OUT PRESENTS FOR LOVED ones far and wide, and a grueling task it can be! Nothing's worse than giving gifts that sit around unused and underappreciated, except perhaps receiving gifts that *you* hate.

We can't solve all your gift-giving dilemmas, and there's nothing we can suggest for folks who don't have computers or CD-ROM drives (perish the thought). However, this guide can help you choose the perfect CD-ROM for all your computer-savvy friends and family.

We picked our favorite CDs, using a stringent set of objective criteria. First, the CDs had to be fast. Too many discs make you sit at your computer tapping your fingers and wondering if anything's happening. Second, they had to be easy to use. If you have to memorize the manual, we bagged the disc. Third, they had to be fun—or at the very least, interesting. Did we say objective? Well, OK, there were some highly *subjective* criteria. Last, we wanted lots of variety and chose CDs from a wide range of categories to make sure there'd be a great gift for everyone on your list.

### Business

#### TEAMS THAT WORK ★★★★★/7.1

A fine present for a small-business owner (but a bit pricey), this CD-ROM teaches business managers how they can work effectively in teams. Using videos, expert commentary, and text explanations, the disc explores the dynamics of teamwork, from conflict management to the use of power. Checklists and worksheets help you assess your team's strengths as well as diagnose its problems. The most enjoyable part of the CD is an interactive case study that

allows you to take on the role of a team member. As you watch QuickTime movies, read memos, and listen to voice-mail messages, you make decisions and confront problems that teams typically face. Through occasionally dry but generally interesting QuickTime videos, author Anne Donnellon offers input about the issues managers face and the choices they make.

*Harvard Business School Publishing, 617/496-1449, www.hbsp.harvard.edu; \$295.*

### Culture

#### TREASURES OF THE AMERICAN MUSEUM OF NATURAL HISTORY ★★★★★/8.2

There are tons of CD-ROMs that let you explore different museums, but this tour of the American Museum of Natural History is one of the best. Wander through 50 exhibits, ranging from meteorites to dioramas. Along the way, read text articles on all 50 topics, listen to recorded speeches, look at photographs, and watch movies and interviews. You can even tour QuickTime VR panoramas of exhibits such as the Akeley Hall of African Mammals. Various surprises, such as a morph demonstrating human evolution, add to the fun. The attractive and appealing interface uses icons to make navigating simple and *a lot* easier on your feet than the real thing. Although this CD is a bit sophisticated for kids (the text is closer to college level than junior-high), several exhibits are fun for all ages. For one, the Dinosaur Dig Game lets you uncover and assemble dinosaur bones in a jigsaw puzzle that any dino enthusiast will enjoy.

*Voyager, 800/446-2001, www.voyager.com; \$40.*

### Documentary

#### WITNESS TO THE FUTURE ★★★★★/7.2

Inspiration doesn't always come in a cheerful package, but





**Witness to the Future** The film footage on this CD includes stark imagery of badly damaged environments.

if you seek thought-provoking material for an environmentally inclined friend, look no further. Based on a film about environmental problems faced in three communities—Hanford, Washington; California's San Joaquin Valley; and Cancer Alley, Louisiana—this disc includes all the film's footage, in addition to complete transcripts of the interviews involved, background information on the towns, and the text of Rachel Carson's *Silent Spring*. Especially compelling are the accounts of various whistle-blowers who have faced persecution and hostility for exposing corruption and dishonesty. The CD also includes links to the Witness to the Future Web site and 250 other sites. You may want to wrap it along with a box of tissues, but rest assured, this moving portrait of real people acting bravely is a gift your friend will not forget.

Voyager, 800/446-2001, [www.voyagerco.com](http://www.voyagerco.com); \$40.

## Fine Art

**PICASSO: THE MAN, HIS WORKS, THE LEGEND** ★★★★★/7.8

Style and substance blend on this CD-ROM starring one of the 20th century's most famous artists. Approved by the Picasso family (and, perhaps as a result, light on criticism of the artist's life), this CD contains more than 600 artworks plus explanations of the styles, techniques, motifs, and themes of Picasso's work. You explore the CD via a Quick-



**Picasso** Picasso himself walks amid 17 of his works of art in the QuickTime VR panorama that provides this CD's basic interface.

Time VR panoramic gallery. Click on one of 17 paintings (which represent the creative periods of the painter's life) to enter a timeline with biographical information, photos, film clips, and more. Best of all, the CD is a remarkable work of art in its own right—theme music and design create a stylish, postmodern look and feel. For example, the alphabet in the index looks scribbled, randomly sized, and disorderly—just as Picasso might have written it himself.

Grolier Interactive, 203/797-3530, [www.grolier.com](http://www.grolier.com); \$40.

## History

**FDR** ★★★★★/8.3

For the history buff in your life, we recommend this CD-ROM detailing the life and times of Franklin Delano Roosevelt. By weaving together movies, photographs, personal documents, vintage audio clips, and newsreel footage, this CD lets you fully explore the longest American presidency. There's smart and articulate analysis by noted historians Doris Kearns Goodwin, Geoffrey Ward, and Bill Leuch-



**FDR** Small touches such as this handwritten excerpt from Roosevelt's draft of the famous "Day of Infamy" speech bring this CD to life.

tenberg. Several touches—including reproductions of historic documents, such as the draft of Roosevelt's speech after Pearl Harbor, and interactive photographic tours of the Roosevelts' five homes—add to the feeling of immediacy. This disc is an especially fine gift for a teenager interested in history, as it really makes the past come alive.

Corbis, 206/641-4505, [www.corbis.com](http://www.corbis.com); \$40.

## Home

**WILLIAMS-SONOMA GUIDE TO GOOD COOKING** ★★★★★/8.3

This mouthwatering cookbook will pique any chef's palate. The CD-ROM contains 50 menus compiled by Chuck Williams, the founder of Williams-Sonoma. Its glossary defines and illustrates hundreds of terms and includes QuickTime movies of cooking techniques. The search engine lets you find recipes by characteristics such as cooking time and ingredients, while the index of 1,000 recipes also makes it easy to find just what you seek. Most CD-ROM cookbooks offer similar features; what distinguishes the Williams-Sonoma cookbook is the sheer beauty of its





**Williams-Sonoma Guide to Good Cooking** Cooks and food lovers alike will lick their lips over this CD-ROM's food photography.

pictures, the interesting food facts scattered throughout, the appeal of its recipes, and its straightforward but remarkably attractive interface. Anyone who enjoys browsing cookbooks will find this one—from its main menu (which looks like a cluttered kitchen table) to its favorite-recipes list worthy of Martha Stewart—a delicious treat.

*Broderbund Software, 415/382-4400, www.broderbund.com; \$40.*

### Kids' Education

**MATH HEADS** ★★★★★/8.2

Wacky, fast-paced, and frantic, this math game might drive parents crazy, but kids ages 10 to 14 will have a good time and learn a lot, too. Using an on-screen remote control, you flip from channel to channel on the Math Head interactive television network. Three game shows challenge you to think fast and to estimate accurately and reward you either with prize money or the chance to create your own music videos. You can even spend your prize money on the shopping channel! In our favorite game, Go Mental, celebrities tell you how they've solved math problems. You decide whether they've done it correctly. Even the infomercial channel teaches practical math skills in a fun and enter-

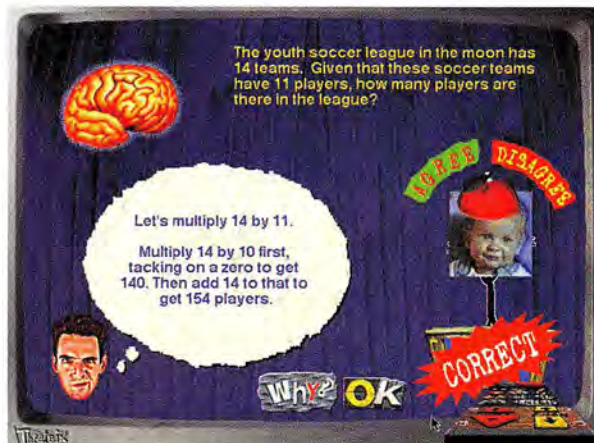

**Math Heads** The game shows on Math Head TV challenge you to think fast and estimate accurately.

taining way. Nothing's going to make math as appealing as MTV, but this game sure comes close.

*Theatrix Interactive, 510/658-2800, www.theatrix.com; \$30.*

### Kids' Entertainment

**PAJAMA SAM IN "NO NEED TO HIDE WHEN IT'S DARK OUTSIDE"** ★★★★★/8.0

In this game for kids ages 3 to 8, Pajama Sam, the world's youngest superhero, sets forth to battle Darkness with his trusty flashlight; mask; and signature-edition all-metal Pajama Man lunch box. Alas, some unfriendly trees swipe his stuff, leaving you to help Sam search the Land of Darkness for his belongings. Along the way, you'll meet dancing furniture and talkative vehicles, plus such notable individuals as the carrot leader of the Salad Liberation Front (whom you help lead a kitchen revolt). Combining the point-and-click animated surprises of Broderbund's Living Books with the problem solving and puzzles of an adventure game, this charming children's game is fun for grown-ups, too.

*Humongous Entertainment, 206/486-9258, www.humongous.com; \$40.*



**Pajama Sam** As Pajama Sam searches for his lost belongings, he discovers—much to his dismay—that the furniture likes '70s disco music.

### Reference

**BRITANNICA CD 97** ★★★★★/7.7

For sheer comprehensiveness, it's tough to beat the Britannica CD 97. With its more than 40 million words of content, you can find information on pretty much any topic. Its natural-language search function lets you ask questions in plain English—"Who invented the computer?"—and returns a list of articles ranked according to relevance. Britannica CD 97 uses the Netscape Navigator Web browser as its functional, but not particularly flashy, interface. If you have Web access, you can link to Britannica Online to download the most-up-to-date information available (at a cost of \$50 per year). Using Britannica isn't smooth—some links don't work—and it lacks the whizzy multimedia features of some other encyclopedias, but it offers an incredible amount of information for a reasonable price.

*Encyclopedia Britannica, 800/747-8503, www.eb.com; \$150.*



## Science

### EYEWITNESS VIRTUAL REALITY EARTH QUEST ★★★★★/7.1

For a one-of-a-kind CD-ROM experience, check out Earth Quest. This beautiful (but slow) science CD lets you explore a 3-D rendered landscape of Earth's interior. In a simulated underground museum, you can create earthquakes or volcanoes and watch their effects on a landscape. You can also wander through galleries of gems, rocks, and crystals, watching them develop and learning how they form. Collect minerals from the galleries and answer questions about Earth to enter the CD's Earth Builder section and learn how the continents formed. Be aware, though, that this CD is a memory hog; with 16MB of RAM, we encountered numerous "out of memory" messages.

DK Multimedia, 440/572-0725, [www.dk.com](http://www.dk.com); \$30. **m**

WENDY SHARP is a freelance writer and coauthor of *Macs for Kids and Parents*, from IDG Books.



**Earth Quest** Learn all about the formation of the continents in this CD-ROM's Earth Builder game. Entire centuries pass in seconds as you watch the continents transform through five geological time periods.

## THE RUNNERS UP

### FIVE FOR KIDS

#### 1 Big Science Comics ★★★★/8.1

This animated comic book for kids ages 8 to 12 offers puzzles that explore physical forces such as buoyancy and elasticity. *Theatrix Interactive*, 510/658-2800, [www.theatrix.com](http://www.theatrix.com); \$30.

#### 2 Freddi Fish 2: The Case of the Haunted Schoolhouse ★★★★/7.7

This amusing underwater story for kids ages 3 to 8 is about ghosts who are not what they seem. *Humongous Entertainment*, 206/486-9258, [www.humongous.com](http://www.humongous.com); \$40.

#### 3 How Many Bugs in a Box? ★★★★★/7.5

This brightly colored, kid-friendly CD includes 8 sim-

ple counting games suitable for kids ages 3 to 6. *Simon & Schuster Interactive*, 212/698-7000, [www.simonsays.com/cddomain/](http://www.simonsays.com/cddomain/); \$20.

#### 4 Orly's Draw-A-Story ★★★★/7.4

The pictures you draw come to life in this cool multimedia storytelling program. *Broderbund Software*, 415/382-4400, [www.broderbund.com](http://www.broderbund.com); \$29.

#### 5 Ready to Read with Pooh ★★★★★/7.4

Pooh fans will love seeing and playing with Piglet, Eeyore, and Roo, although this game for ages 3 to 6 is a little slow. *Disney Interactive*, 818/543-4300, [www.disney.com](http://www.disney.com); \$35.

### FIVE FOR GROWNUPS

#### 6 Leonardo da Vinci ★★★★/7.7

This richly detailed CD-ROM on Leonardo da Vinci enables you to explore a gallery of his work. *Corbis*, 206/641-4505, [www.corbis.com](http://www.corbis.com); \$50.

#### 7 A Night to Remember ★★★★/7.3

Immerse yourself in the details of the *Titanic's* famous demise. The CD includes the complete footage of its namesake 1958 movie. *Voyager*, 800/446-2001, [www.voyagerco.com](http://www.voyagerco.com); \$30.

#### 8 Canon Photography Workshop ★★★★★/7.2

Learn how to improve your photographs through hands-on lessons in this

nically designed CD. *Multicom*, 206/622-5530, [www.multicom.com](http://www.multicom.com); \$20.

#### 9 Elle Cooking ★★★★/7.1

The simple interface of this CD is perfect for those pressed for time, and its 2,000 recipes look delicious. *Grolier Interactive*, 203/797-3530, [www.grolier.com](http://www.grolier.com); \$30.

#### 10 Castle Explorer ★★★/6.9

This beautiful but slow CD lets you explore a medieval castle. *DK Multimedia*, 440/572-0725, [www.dk.com](http://www.dk.com); \$30.





# IS THIS JAZ OR THE *hustle?*



Once you get past the cute name and trendy packaging, the only thing Jaz® users have left is a thinner wallet. Good thing there's DynaMO® 640 removable storage from Fujitsu. DynaMO 640 is much more durable because it's magneto-optical (unlike Jaz). It

lets you save your work on different media capacities ranging from 128MB to 640MB (unlike Jaz). You get free tech support (unlike Jaz). And it's less than half the cost of Jaz media\* with a 640MB cartridge going for only \$25. (Bye-bye Jaz.) There's also our No Excuses™ policy: Our promise that in the unlikely event your drive fails within warranty period, you'll get a replacement drive in two business days. For more details, without the hustle, call, or visit our website.

(800) 462-0273 [www.fcpa.com](http://www.fcpa.com)

©1997 Fujitsu Computer Products of America. DynaMO is a registered trademark and No Excuses is a trademark of Fujitsu Computer Products of America, Inc. All rights reserved. Jaz is a registered trademark of Iomega Corp. \* PC Magazine Online 6/12/97.

Circle 202 on reader service card



## **GIMME FIVE FREE**

Get a free 3.2 gigabyte 5-pack of media when you buy a DynaMO 640 before Jan. 31, 1998.

For all the details, call (800) 462-0273 or visit [www.fcpa.com](http://www.fcpa.com).

# FUJITSU



# Jack Nicklaus® 4

**"10 out of 10"**  
"Jack Nicklaus 4 is arguably  
the best golf sim ever."

Boot

**"★★★★★"**  
"An absolute model of  
perfection. Graphically  
meets or exceeds anything  
on the market, including  
Links LS®."

Computer Gaming World

- **Stunningly Gorgeous**  
Graphics so detailed they look  
like photos.
- **Complete Course Designer**  
Design your own courses. Or, import  
any of the hundreds available on the web.
- **Most Realistic Golf Game Ever**  
Highly-accurate ball physics, multiple swing meters,  
new green reading tools and more!

Featuring **5** Jack Nicklaus designed courses:

Colleton River Plantation • Country Club of the South • Muirfield Village  
Cabo del Sol • Winding Springs • **Includes 90 holes.**



Beautiful high speed graphics, a true physics  
model, more realistic swing meters, better putting  
and unlimited camera positions.



Intensity control lets you shape shots  
with club selection and power.



Use the powerful designer to create  
your own masterpieces or play courses  
created by others.



**800-229-2714**

Call for a free catalog or visit our  
website at [www.wizworks.com](http://www.wizworks.com)

**MacSoft®**

An Affiliate of GT Interactive Software  
2300 Berkshire Lane, Plymouth, MN 55441 612.509.7600

Jack Nicklaus and the Golden Bear symbol are registered trademarks of Golden Bear International. Accolade is a trademark of Accolade, Inc. Apple, Macintosh, and MacOS are registered trademarks of Apple Computer, Inc. All other product names are of their respective owners. Produced in association with Jack Nicklaus Productions, Inc. Developed by Eclipse Entertainment. Published under license by Accolade, Inc. ©1997 Accolade, Inc. All rights reserved.

Circle 40 on reader service card



by Allyson Bates

# Bargain Systems

## BUY THE BEST MAC UNDER \$2,000



**A**T THE HEIGHT OF THE holiday season, more than a dozen new Mac models are available for less than \$2,000 each—and at those prices, even Scrooge himself wouldn't be able to resist getting a new Mac right now. Whether you're shopping for loved ones or searching for an addition for your office, there's a way to find the perfect Macintosh without breaking your budget.

### Make a List

Buying a new computer can be pretty intimidating. Even power users don't have to think about such things as CPU clock speed, Level 2 cache, and bus speed very often. But you'll need to know what to look for inside the case of a low-cost Macintosh if you want to get the best one for your money.

First decide how much you want to spend and who will be using the new machine. Whether you're buying a Macintosh for a rabid game player, your grandmother, or your own small business, you will need to find the system that best fits the job.

Fortunately, you have plenty of choices. Apple Computer and Umax Computer offer a whopping 13 Mac models for less than \$2,000 each. (For a complete list of the features those models offer, check out the table, "A Budget's Best Friend: 13 Macs Under \$2,000.") And if you hurry, your selection won't be limited to those two companies—you can also look for closeout systems from companies leaving the Mac-clone market, such as APS Technologies (813/483-1600, [www.apstech.com](http://www.apstech.com)), Motorola Computer

Group (800/759-1107, [www.mot.com/starmax/](http://www.mot.com/starmax/)), and Power Computing (512/388-6868, [www.powercc.com](http://www.powercc.com)).

### All the Trimmings

Despite what you may have heard, a computer's speed isn't dictated exclusively by the speed of its CPU. It's influenced by a combination of several interdependent factors: the processor type and speed, the amount of RAM installed, bus speed, cache, and video RAM. Because a chain is only as strong as its weakest link, you should carefully balance these categories.

**CPU Type** When it comes to low-cost Macs, two CPUs prevail: the PowerPC 603e and 604e. Most of the low-cost Macs are 603e-based, but if you stumble across a good bargain on a 604e-based Mac, such as Umax's \$1,795 SuperMac J700/180, you should snap it up. According to Macworld Lab tests, systems based on the 604e are usually 30 percent *faster* than 603e-based Macs running at the same

clock speed. Apple's latest low-price system, the \$1,999 Power Mac G3 (see "Apple's Next-Generation Systems," in this issue), uses the PowerPC 750 CPU—an even speedier CPU than the 604e.

**CPU Clock Speed** Although it *is* important, clock speed, which is measured in megahertz (MHz), is one of the most overrated indicators of computer speed. For example, a 250MHz CPU is typically 5 to 10 percent faster than a 225MHz CPU—and costs roughly \$400 more. That increase may be a big deal for artists trying to push Adobe Photoshop to its limits, but for Finder operations and for most general applications, you won't notice the difference.

**Bus Speed** Since the Mac's system bus regulates the speed at which the CPU communicates with the rest of the system, having a fast CPU with a slow bus is a little like driving a Ferrari in a traffic jam. Avoid Macs with slower, 40MHz buses if possible.

**Cache Together**, CPU



clock speed, bus speed, and Level 2 cache are the three most important factors determining how fast your Mac runs. The cache ensures that the CPU isn't forced to stop doing work while it's waiting for the bus to catch up with it. Because most people don't realize the importance of cache, many low-cost systems come with *none*. Insist on a cache of at least 256K. And if you're lucky, you'll find a system such as the \$1,795 Umax SuperMac C600x/240, which comes with a hefty 1MB cache.

**RAM** When it comes to memory, too much is never enough. These days, RAM is dirt-cheap (approximately \$60 for 16MB), so leave room in your budget for extra RAM. Most budget Macs are configured with a mere 16MB of RAM. If you plan to use your computer only for e-mail or other basic tasks, you can get by with that much, but if you're hunting for a bargain gaming computer or want to do entry-level desktop publishing, RAM is a good place to splurge. We recommend

32MB to 48MB for most gamers and business users.

**VRAM** Video memory, or VRAM, is important for all computer users, but it's especially important for gamers and users of graphics-oriented programs, since it lets a monitor display greater detail and more colors and speeds up screen drawing. When you buy your new Mac, request at least 2MB of VRAM—and make sure the VRAM can be increased to 4MB. Most economy systems, including most of Umax's SuperMac C600 and

C500 series, come with only 1MB of VRAM.

**Hard Drive** Every Mac we looked at has at least a 1.2GB hard drive, but you can never have too much storage. The good news is that 2GB drives are cheap and higher-capacity drives aren't a lot more expensive. Your software collection and files will only grow with time, especially if you're going to store large graphics files or install massive CD-ROM games on your hard disk. Our advice: Get plenty of storage now—preferably 2GB to

## A BUDGET'S BEST FRIEND: 13 MACS UNDER \$2,000

Company	Product	Star Rating <sup>A</sup>	Company's Estimated Price	Speed-Mark <sup>B</sup>	SPEED-RELATED FEATURES				MEMORY		
					CPU Type	CPU Speed	L2 Cache	Bus Speed	Free RAM	RAM Slots	VRAM (std./max.)
Apple Computer 408/996-1010 www.apple.com	Power Macintosh 4400/200	★★★/5.5	\$1,500	1.9	603e	200MHz	256K	40MHz	16MB	3	1MB/1MB
	Power Macintosh 5500/225	★★★/6.7	\$2,000	2.1	603e	225MHz	256K	50MHz	32MB	0	1MB/1MB
	Power Macintosh 6500/225	★★★/6.1	\$1,600	2.1	603e	225MHz	256K	50MHz	32MB	2	2MB/2MB
	Power Macintosh 6500/250	★★★/6.0	\$2,000	2.2	603e	250MHz	256K	50MHz	48MB	2	2MB/2MB
	Power Macintosh G3	NA <sup>C</sup>	\$1,999	4.0 <sup>C</sup>	750	233MHz	512K	66MHz	32MB	2	2MB/6MB
Umax Computer 510/226-688 www.supermac.com	SuperMac C500LT/200	★★★/5.4	\$995	1.7	603e	200MHz	256K	40MHz	16MB	2	1MB/1MB
	SuperMac C500/240	NA <sup>C</sup>	\$1,295	1.8 <sup>C</sup>	603e	240MHz	256K	40MHz	24MB	2	1MB/1MB
	SuperMac C600/200	★★★/5.1	\$1,195	1.8	603e	200MHz	256K	40MHz	16MB	2	1MB/1MB
	SuperMac C600LT/240	★★★/5.0	\$1,395	1.9	603e	240MHz	256K	40MHz	24MB	2	1MB/1MB
	SuperMac C600x/240	★★★/6.0	\$1,795	2.4	603e	240MHz	1MB	80MHz <sup>F</sup>	32MB	2	1MB/1MB
	SuperMac C600x/280	★★★/6.2	\$1,995	2.5	603e	280MHz	1MB	80MHz <sup>F</sup>	32MB	2	2MB/2MB
	SuperMac J700/180	★★★/5.6	\$1,795	2.7	604e	180MHz	512K	51.2MHz <sup>F</sup>	24MB	8	2MB/4MB
	SuperMac J700/233	NA <sup>C</sup>	\$1,995	2.7 <sup>C</sup>	604e	233MHz	512K	40MHz	24MB	8	4MB/8MB

● = yes; NA = not available <sup>A</sup> Based on features, implementation, innovation, performance, reliability, ease of use, and value. <sup>B</sup> Macworld Lab's SpeedMark test compares different systems' real-\$100 more. <sup>F</sup> Available with Ethernet for \$100 more. <sup>F</sup> Cache-doubler technology installed to increase bus speed.



4GB—to avoid having to swap drives in the future.

### Stocking Stuffers

When you've taken care of what's inside your Mac, you're still not done—in many ways, the peripherals you add to your system are just as important as what's inside.

**Monitor** Without a monitor, your new Mac won't do anything but collect dust. Unfortunately, most Macs don't come with this must-have peripheral, so you'll need to budget an additional \$300

for a decent 15-inch monitor. Although a 17-inch display (which costs about \$700) expands your viewing capabilities (and is especially appealing to gamers and publishers), most business and home users will find a 15-inch monitor perfectly usable. No matter what size you choose, check out "17-Inch Screen Stars," July 1997, for more details about what you should look for in a monitor.

**CD-ROM Drive** These days, all computers have preinstalled CD-ROM drives. Although



**Software Star** A good price, speedy CPU and bus, and stellar software bundle highlight the Apple Power Macintosh 6500/225.

STORAGE			EXPANSION		NETWORK		COMMENTS		
Hard Drive	CD-ROM Drive	Zip Drive	Case	Free PCI Slots	Modem	Ethernet	Pros	Cons	Ideal Users
2GB	8x		desktop	2		●	Good price, 2 PCI slots, upgradable VRAM, 3 RAM slots	Proprietary DIMM slots, not enough RAM, slow bus	Small businesses, home offices
1GB	12x		all-in-one	0		●	Built-in monitor, speedy	No PCI slots, not much VRAM, sold only to education market	Schools, students
5GB	12x	●	tower	2		●	Affordable, speedy, fast bus, great software bundle	Accepts only 7-inch PCI cards, VRAM not expandable	Home offices, cross-platform users, publishers
1GB	12x	●	tower	2		●	Lots of RAM, high-capacity hard drive, speedy, great software bundle	Pricy, accepts only 7-inch PCI cards, VRAM not expandable	Small businesses, Web surfers
1GB	24x		desktop	3	●	●	Extremely fast 750 CPU, expandable	Price may be too high for some	Power users on a budget
1GB	8x		desktop	2	<sup>D</sup>	<sup>D</sup>	High-capacity hard drive, good price	No built-in connectivity, slow bus	Do-it-yourselfers who want a base system
3GB	24x		desktop	2		<sup>E</sup>	High-capacity hard drive, good price	VRAM not expandable, slow bus	Do-it-yourselfers who want a base system, small businesses
2GB	8x		tower	3	●		Good price	Not much RAM or VRAM, low-capacity hard drive, slow bus	E-mail users, students, infrequent users
1GB	12x		tower	3	●		Good value	Not much VRAM, VRAM not expandable, slow bus	Home offices, e-mail users, students
1GB	12x		tower	3	●	●	Speedy bus, large cache, high-capacity hard drive	Not much VRAM, VRAM not expandable	Small businesses, home offices, publishers, Web surfers
1GB	12x		tower	3	●	●	Speedy bus, fast CPU, large cache	Pricy	Small businesses, home offices, gamers, publishers
1GB	8x		desktop	4		●	Fast 604e CPU, fast bus, free RAM and PCI slots, upgradable VRAM	Not as fast as comparably priced system with 750 CPU	Gamers, publishers
1GB	24x		desktop	3	●	●	Fast 604e CPU, fast bus, free RAM and PCI slots, upgradable VRAM	Not as fast as comparably priced system with 750 CPU	Gamers, publishers

world application performance. Scores are relative to that of an Apple Power Macintosh 7100/80, which has a SpeedMark score of 1.0. <sup>C</sup> Preproduction model. <sup>D</sup> Available with Ethernet or a modem for



## A LOW-COST-MAC SHOPPING LIST

Your quick-reference guide to Mac options



CPU type	PowerPC 603e; 604e or 750 if you can
Processor clock speed (MHz)	180MHz or faster; don't pay a premium for a small speed bump
Bus speed	faster than 40MHz
Cache	at least 256K
RAM	24MB or 32MB
VRAM	2MB, preferably upgradable to 4MB
Hard drive	at least 1.2GB; consider getting 2GB
Monitor	15-inch; 17-inch if you're a gamer or publisher
CD-ROM drive	8x; don't pay a premium for a faster drive
Printer	none; a color ink-jet if you really need to print
PCI slots	at least one
Free RAM slots	at least one

most Macs are sold with an 8X CD-ROM drive, don't be fooled by the speed ratings. The cost of upgrading to a faster CD-ROM drive just isn't worth it—the speed differences aren't particularly noticeable.

**Communications** Some computers include built-in communications capabilities, such as a modem, Ethernet networking, or both. If you plan to physically link your computer to a network, you can either buy a Mac with built-in Ethernet or add it via an expansion card (about \$100). If your computer is going to live by itself and communicate only with a printer, you don't need Ethernet at all. If you're planning to use your Mac for connecting to the Internet or an online service, be sure to get a 28.8-Kbps or faster modem. Unless you're an Internet power user, you probably don't need to pay extra for a 56-Kbps modem.

**Software Packages** Consider the quality and quantity of a system's software bundle if you're looking to beef up your

software library. First-time buyers should pay special attention to which programs are bundled, so they can be up and running as soon as they plug in their Macs.

**Printer** If you're strapped for cash, don't buy a printer right away. In the age of e-mail and electronic correspondence, generating hard copy may not be necessary. If you do need to print, consider getting a color ink-jet printer (about \$300). For more detailed information about printers, see "Print It," November 1997.

### One to Grow On

At this stage, your new computer system is almost complete—for now. But in the future, when you've got more money to spend, you may want to expand your system. Be careful not to paint yourself into a corner before the computer is even out of the box.

**Form Factor** Deciding between a tower and a desktop Mac depends on how you want to configure your workspace and how much expandability you require. Tower systems are

usually more expandable and can be stowed under a desk. Desktop systems generally offer fewer upgrade opportunities, including fewer free RAM and PCI slots. A desktop Mac fits neatly under a monitor and often acts as an excellent monitor stand. (If you buy a tower Macintosh, be certain to buy a monitor stand as well.)

**PCI Slots** The number of free PCI slots dictates how many add-ons your Mac can accommodate. Be wary of a system with no available slots—it'll be a nightmare to upgrade. And don't confuse the total number of slots with the number of free slots; some vendors fill up every slot with video cards and other options.

**RAM Expansion** It's wise to have free memory slots for adding more RAM to your Mac in the future. Don't buy a computer with no free RAM slots, because then you'll have to replace your existing RAM instead of simply adding to what you've already got.

### Santa's Helpers

OK, now you know how to get a Mac that suits your needs—and your budget. Next you need to find somewhere to go shopping.

Right now Apple and Umax don't sell directly to customers—to buy one of their systems, you have to go through an authorized dealer. If you're not having much luck at resellers such as CompUSA or MacFrugal's, browse some catalogs. In many cases, you'll find an even better deal if you purchase a Mac via mail-order. And it's always smart to check out vendors' Web sites for bargains on systems no longer available retail.

Another affordable possibility for holiday shoppers is to check out marked-down inventory from such vendors as Motorola and Power Computing. Substantial price drops

on current lines make these computers affordable—but inventory won't be replenished, so if the shelves are empty, you're out of luck.

### The Last Word

You wouldn't buy your dad an ugly tie for the holidays, and you wouldn't buy your mom a rock-hard fruitcake. Likewise, don't buy a Mac that won't serve your family well a year from now. With your wish list in hand (for quick reference, be sure to take our "Low-Cost-Mac Shopping List" along with you when you head out to go shopping), you'll be sure to keep yourself and your loved ones happy this holiday season. **m**

Associate editor ALLYSON BATES finds time between shopping sprees to cover Mac systems for *Macworld*.

## EDITORS' CHOICE

With the imminent arrival of Apple's new \$1,999 Power Macintosh G3 (see "Apple's Next-Generation Systems," in this issue), we can't currently recommend any particular low-cost Mac. If the G3 is as speedy as our preliminary tests indicate, the new Power Mac will clearly be the best Mac you can buy for less than \$2,000.

However, if the presence of machines that use the G3 leads to big price cuts, the other Macs we looked at might become even greater finds for bargain-hunters. Apple's Power Macintosh 6500/225 and Umax's SuperMac J700/180 are solid systems that would be great values if their prices were to drop in reaction to the introduction of the Power Mac G3.

### REAL PRODUCTS REAL RATINGS

**Reviews you can trust** Unlike other publications, *Macworld* rates only final shipping products, not prototypes. What we review is what you can actually buy.



# DO IT IN A PLACE YOU'VE NEVER DONE IT BEFORE.

SLASH DESIGN TIME, CREATE STUNNING EFFECTS AND PREFLIGHT RIGHT IN QUARKXPRESS®



Extensis QX-Effects

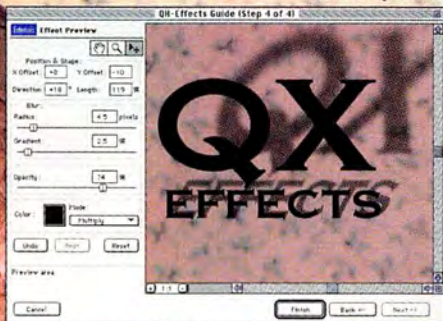

Extensis Preflight Designer



Extensis QX-Tools

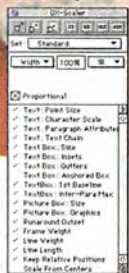

## EXTENSIS POWERSUITE FOR QUARKXPRESS

3 GREAT PRODUCTS!  
ONE INCREDIBLE LOW PRICE!

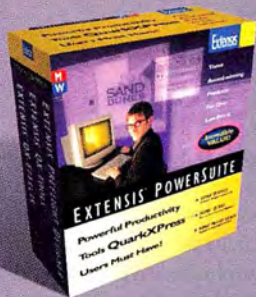

## EXTENSIS POWERSUITE FOR QUARKXPRESS

MACINTOSH \$199.95

1.800.796.9798

Now you can get three award-winning Extensis productivity software packages for QuarkXPress for one incredibly low price.

### The Extensis PowerSuite for QuarkXPress includes:

**Extensis QX-Tools®** — 15 time-saving tools that slash through QuarkXPress projects. With QX-Tools you can scale multiple objects, use layers, apply character styles, use a powerful search and replace engine and much more.

**Extensis QX-Effects™** — Quickly create professional cast and drop shadows, bevels and glows right in QuarkXPress. Interactively preview and custom design each effect. QX-Effects intelligently determines the optimal resolution and color mode so your designs print perfectly every time.

**Preflight Designer™** — The easy-to-use advanced preflight solution for designers. Intelligently inspect your QuarkXPress files and collect every file, font and image you need for perfect printing. Preflight Designer kills output problems before they cost you time and money.

So do it in a place you've never done it before, in a way you've never done it. And, save like never before with the Extensis PowerSuite for QuarkXPress.



DOWNLOAD FREE TRIAL VERSIONS

<http://www.extensis.com>

Circle 13 on reader service card





# Irresistible Extras

TREAT YOUR FRIENDS  
(OR YOURSELF!)

**E**VEN IF YOU CAN'T AFFORD THE EXTRAVAGANT GIFT of a new Mac, there's still a whole sackful of ways to brighten the holiday season of the Mac fanatics on your list. *Macworld's* elves braved the holiday weather searching for the coolest gifts, so you can spend your time decking the halls of your home office with gadgets and goodies, transforming it into a wired winter wonderland. After the other presents have made their ways deep into drawers and to the back of the cupboard, these gifts will delight your favorite Mac lovers well into the new year.

## Groovy Ghoulies

AWESOME ANIMATED MONSTER MAKER ★★★/5.0

What's green and red and has six legs? Beats me . . . but I just built one, using the Awesome Animated Monster Maker. This CD-ROM lets kids ages 3 and up create the monster of their dreams (or nightmares) by assembling wiggling pieces, using a "color bath" to select its color scheme, and endowing their creation with one of six personalities via a brain transplant. It can take a while to get the hang of the way the laboratory works, but its proprietor—Dr. Lizardlips—and other critters keep up a wisecracking banter (poor sound quality can make them hard to understand, though). For kids with good reading skills, printed tips appear while different sections load. With your monster complete, you tour a 14-room palace, accessorizing your creature with clothing;

changing its body parts; assigning it new personalities, moods, and animated actions; and playing games. Game rooms such as Part Drop and Judo require good hand-eye coordination; Spaghetti & Meatball's Kitchen works on memory, spelling, and typing skills. My favorite room is the Sewer, where your monster watches an interactive concert; you click on the musicians to make them play their riffs. You can print your monsters in full-color glory (or is that "gory"?), make coloring-book versions with just the outlines, or export your creations as graphic files.—KATHERINE ULRICH

*Houghton Mifflin Interactive, 617/503-4800, [www.bminet.com](http://www.bminet.com); \$35.*

## An Instant New You—Sort Of

COSMOPOLITAN VIRTUAL MAKEOVER ★★★/3.1

Oh, the girlish glee! At last, a CD-ROM that speaks to the frivolous and frolicsome female in all of us and offers a way to experiment with hair and makeup without lasting consequences. Unfortunately, after wrestling with *Cosmopolitan Virtual Makeover*, you'll want to pull your hair out, not restyle it. Too bad, because it's based on a great premise: You import a digital photo of yourself and try out dozens of different haircuts, hair colors, and eye colors. You can fix your face with virtual foundation, eye shadow, and lipstick in real Cover Girl shades. You can even add beauty marks and tweeze your eyebrows into pixel-perfect arches. Alas, *Virtual Makeover* is painfully, horribly slow; your hair may go gray before you get to see yourself as a virtual blond. Other deterrents to girlish fun include cheesy music and the program's tendency to choke on imported photos. When all is said and done, it's just



no replacement for being invited to a *Ricki Lake* makeover special.—BROOKE WHEELER

SegaSoft, 888/734-2763, [www.virtualmakeover.com](http://www.virtualmakeover.com); \$40.

## Countdown to Christmas

SANTAZIA ★★★/5.4

When I was a kid, advent calendars helped ease the countdown to Christmas, rewarding my patience each day with a new picture. Santazia, a computerized version of the old favorite, rewards players with daily 3-D animations and games. Santa, who narrates in your choice of 10 languages, needs you to find 24 enchanted objects in his castle to undo the hex that threatens Christmas deliveries. QuickTime VR lets you smoothly navigate the castle rooms, and sounds—such as creaking doors, dripping water, and crackling fires—mark your movements and location. Once located, the enchanted Old World-style objects come to life with contemporary flair: tabletop trees play soccer with an ornament, candy canes slink like charmed snakes, and rotund ornaments tire after a tribal jive. Individual games (which include memory, matching, and scenic



**Santazia** By Christmas Eve, you'll uncover 24 animated objects and their accompanying games.

puzzles) offer no spoken or written instructions, but figuring them out adds to the challenge. Santazia doesn't really make Christmas come quicker, but it makes the wait more fun.—ELIZABETH DOUGHERTY

Caspari, 203/888-1100, [www.metronome.dk/santazia/](http://www.metronome.dk/santazia/); \$30.

## As the World Turns

3D ATLAS 98 ★★★/6.3

If anyone on your shopping list spends hours spinning a globe or thumbing through an almanac, 3D Atlas 98 is sure to be a year-round favorite. With this innovative CD-ROM, it's easy to make a chart of two statistics, such as comparing the number of goats in a country and its per capita gross national product. You can view an image of a globe in physical relief or with country borders indicated, adding cities, mountains, rivers, and other points of interest as you choose. Most statistics are current as of 1994, and borders and country names are up-to-date—listing



**3D Atlas 98** This innovative CD-ROM takes countries' statistics and maps well beyond the two-dimensional world of reference books.

Congo-Kinshasa instead of the recently out-of-date Zaire, for example. Web integration provides links to sites related to a topic or country, and QuickTime movies illustrate countries' historical events, as well as geological, environmental, and climatic features. Pleasant background music and voice-overs accompany many of the CD-ROM's screens. Whether you've got wanderlust or just want to know more about your world, this CD-ROM will do the trick.—KEITH MITCHELL

Creative Wonders, 650/482-2300, [www.creativewonders.com](http://www.creativewonders.com); \$30.

## No Mere Magic 8-Ball

MULTIMEDIA I CHING ★★★/7.0

This disc serves up a gracious and comprehensive course in the ancient oracular system known as the Book of Changes. The texts conjoining the I Ching's 64 hexagrams are at once precise and poetic, pithy and prodigious, and have provided Confucian and Taoist scholars with cosmic insights for three millennia. Virtual seekers will likely prostrate themselves before Multimedia I Ching's sacred ambience of warmly lighted reading rooms and sweet, caressing music. After you place a question before the Oracle, the



**Multimedia I Ching** The Oracle Pavilion offers a tranquil setting for you to consult the Book of Changes.



disc prompts you to select a divining method for building a hexagram. (The coin throw is most hypnotic.) The reading screens are especially easy on the eyes and contain full texts of the images and interpretations behind each hexagram. Reading rooms offer a wealth of other information, including voice-recorded lessons in pronunciation, and all aspects of this quiet refuge—its sound, music, and imagery—can be easily customized.—MARK BAARD

Princeton University Press, 800/777-4726, [www.pup.princeton.edu](http://www.pup.princeton.edu); \$50.

## Roll with It

EXOTIC SUSHI ★★★★★/7.7

Whether you take sushi seriously or pop tekamaki by the handful, the Exotic Sushi CD-ROM makes a perfect gift. It teaches you how to prepare four types of sushi, starting with party rolls and eventually helping you graduate to the most difficult type, nigiri. Even more important than the preparation directions are the tips on enjoying sushi. You'll



**Exotic Sushi** In addition to teaching you sushi-bar etiquette, this CD illustrates the construction of edible masterpieces.

learn insider information such as locating the tastiest part of the yellowtail and determining which sushi is ruined by dipping in soy sauce. The CD-ROM's video demonstrations make it easy to learn the customs they don't teach you at the local sushi bar.—NANCY PETERSON

Bandai Digital Entertainment, 714/816-9700, [www.bdec.com](http://www.bdec.com); \$30.

## Make It and Bake It

SUPER JEWELRY KIT ★★★★★/7.1

With a little help from your Mac and your printer (and your oven), you can design and create custom jewelry. Super Jewelry Kit comes packed with all the supplies needed to make funky earrings, cool necklaces, beaded bracelets, and wildly colorful pins. Its animated interface helps you select pieces, add hues and patterns, and even type personal messages. Within minutes, you can transform a simple earring design into a unique creation of psychedelic swirls, floral decorations, and checkered patterns.



**Super Jewelry Kit** With an oven and a color printer, you can use your Mac to design and create one-of-a-kind wearable art.

If you have a scanner or a digital camera handy, you can easily convert your favorite photo into a beautiful brooch. If you get stuck, Max the Multimedia Mutt will talk you through each step, and once your design is complete, you simply print the image to special print-and-shrink paper, cut out your masterpiece, and pop it into the oven. This fun kit eats up a monstrous 14MB of RAM, and although Super Jewelry Kit is intended for ages 8 and up, it requires some adult supervision for threading the special paper into the printer and using the oven.—ALLYSON BATES

Print Paks, 503/295-6564, [www.printpaks.com](http://www.printpaks.com); \$25.

## Smoke 'Em If You've Got 'Em

THE CIGAR COMPANION INTERACTIVE 2.0 ★★★★★/6.0

Ask any cigar smokers what to drop in their stockings, and you'll probably get the names of a few esoteric (and expensive) stogies, a plea for silver-plated accessories, or a wistful wish for a humidor. If you don't want to encourage the actual *smoking* part of the hobby, your favorite puffer can still peruse text, audio, and QuickTime movies about cigars, from the history of tobacco and how it's grown to guided tours of a modern cigar factory and the assembly process. The Cigar Companion features a database of the most-pop-



**The Cigar Companion Interactive** Cutting and lighting tutorials help you learn the esoteric skills of a true aficionado.



ular brands and lets you create your own dossier of cigars you've smoked. The database also contains basic information about the character of the various cigars, but don't buy the disc expecting thorough reviews. If you can't bear the thought of a subscription to *Cigar Aficionado*, here's a gift the cigar smoker in your life can enjoy . . . without stinking up the house.—CAMERON CROTTY

*Inroads Interactive, 303/444-0632, www.inroadsint.com; \$20.*

## Up, Up, and Away

VIRTUAL WINGS ★★★★★/8.2

By modeling the French Aerospatiale Tobago training aircraft, and including actual Jeppesen airport approach and facilities diagrams, Virtual Wings brings low-cost, realistic flight to the Mac, accurately simulating both instrument and visual flight to hundreds of U.S. and Italian airports. It renders 28 geographic locales, optionally augmented by QuickDraw 3D accelerator cards, such as Apple's QD3D Accelerator or ATI's Xclaim VR. For realistic training conditions, the program depicts haze and surface textures, city



**Virtual Wings** This unique flight simulator lets you fly a realistic model of a general-aviation aircraft.

lights at night, highway traffic, cloud conditions, gusty winds, and wind shear. An instructor's console lets you simulate partial and full instrument failures and adjust weather conditions. Virtual Wings' out-the-window view is stunningly beautiful, all instrument indications are very realistic, and the program's library of preconfigured settings lets you experience a range of flight situations. Although the simulator is designed for serious pilots, Virtual Wings' clear user guide explains aircraft operation well enough that anyone can enjoy the program. Combined with an external flight control stick—such as one from CH Products, ThrustMaster, or Gravis—it's sure to please the heavenly-minded on your holiday gift list.—MEL BECKMAN

*CAT III Systems, 800/322-8866, www.cat3.com; \$119.*

## Uncle Jerry's Disc

THE PSYCHEDELIC BUS OF DEAD KNOWLEDGE ★★★★★/6.5

How many musicians were involved in the making of the

Grateful Dead studio album *Terrapin Station*? What type of bird is mentioned in "Sugar Magnolia"? If you know the answers, chances are you're a Deadhead and that you'll enjoy *The Psychedelic Bus of Dead Knowledge*, a CD-ROM trivia game. The questions don't focus exclusively on the music but also pertain to the band's friends and influences. Users might be asked to listen to an audio clip and determine which live or studio album it hails from, or pinpoint which Ken Kesey essay includes references to the Dead. Fans will love the audio clips (many of which come from the band's greatest live performances), and the trivia is interesting and well researched. The QuickTime video segments are grainy, and the CD-ROM just isn't slick enough to merit its price, but tour-deprived Deadheads may find the opportunity to flex their band knowledge, wax nostalgic, and do the signature Deadhead bop to a great live version of "Brokedown Palace" well worth the price.—KRISTIN BALLEISEN

*Cosmic Light Computing, 804/823-7766, www.psychedelicbus.com; \$50.*

## Classy Case and Stylish Stylus

PALMPILOT ACCESSORIES ★★★★★/6.9

Many a good little geek found a Palm Computing PalmPilot (see "Top Pocket Organizers," September 1997), among the brightly wrapped packages last holiday season. If one of those lucky folks is on your list this year, you can help bring their merriment back for another season with selections from the PalmPilot accessories catalog. If a plastic stylus is just too ordinary for your favorite PDA junkie, you might favor a Cross DigitalWriter, a stylus replacement that looks just like the famous pens, available in 10-karat gold, chrome, or black lacquer. Posh luggage purveyor Dooney & Bourke offers a full line of "all-weather leather" cases specially made for the PalmPilot, from a slim, fold-over sheath to a large-format, planner-style portfolio complete with a real (paper!) notepad; all three come in your choice of black, tan, or ivy leather. Sure, there are cheaper trinkets to stuff into a stocking, but nothing's too good for your favorite PDA.—ANITA EPLER

*PalmPilot Accessories, 408/848-5604, www.palmpilot.com. DigitalWriter stylus, \$30 to \$65; Dooney & Bourke cases, \$50 to \$100. ■*



**PalmPilot Accessories** For people who can't bear to be separated from their PDAs, these accoutrements make super gifts.





---

**CONSUMERS HAVE A VERY DIFFERENT ATTITUDE  
WHEN IT COMES TO DOING BUSINESS ON THE WEB.**

---

Whether it stems from a sensational story heard on the nightly news or simply a natural fear of the new and unknown, consumers don't trust cyberspace to protect their privacy.

In fact, about 70% either leave a website or report false data as soon as a request for personal information is made online.

However, a study by the Boston Consulting Group shows that if the privacy policies of sites were disclosed, users would be two to three times more likely to give information and partake in Web transactions. Which would result in a doubling of consumer e-commerce from

\$6 billion to \$12 billion by the year 2000.

So how can you earn consumer trust on the Web? Become a TRUSTe licensee. Then with just a click on your website's TRUSTe symbol, users will be able to easily access your privacy statement. The TRUSTe initiative also assures consumers that sites which use our symbol are routinely monitored to ensure displayed information is correct and complete.

To find out more about how to become a licensee, visit our  [www.truste.org](http://www.truste.org) website. After all, earning consumer trust is simply good business.

TRUSTe is an independent, non-profit, privacy initiative sponsored by:





# Secrets

## Calmly Coping with File Disasters

HOW TO CURE YOUR MAC WHEN IT GETS THE DIGITAL HICCUPS

by Joseph Schorr

**T**he other day, I realized that I prefer my Macintosh to a Windows 95 machine not because of the Mac's vastly more intuitive operating system, or its seamlessly integrated multimedia capabilities, or its beautifully refined interface, but because of the way it crashes, hangs, freezes, and otherwise misbehaves. That's right. I'm most grateful to be a Mac user not when everything on my system is humming along perfectly but when I encounter an unexpected glitch that needs fixing.

Mac magazines like this one are filled with pages of Mac-versus-Windows speed tests and price comparisons, but in my opinion, the real test should be what happens when something goes wrong—when the hard disk becomes unreadable, or the printer drivers become corrupted, or critical files get misplaced or deleted. When disaster strikes, I'd rather have a Mac, which is eminently easier to troubleshoot and fix.

Of course, I'd really rather have a system that runs flawlessly, that *never* corrupts a file and *never* quits unexpectedly. But let's face it, there isn't a computer out there—regardless of the platform—that doesn't experience its share of problems. Life with computers is inherently filled with disaster. If you want to stay productive, the key is knowing how to cope with these glitches effectively—without calling technical support



or spending money on unnecessary software, hardware, or consultation fees.

Few of these glitches, though, are as disastrous as they initially seem. This column isn't meant to be a comprehensive troubleshooting guide, but here are a few of my favorite coping strategies for some of the odd little problems that could potentially ruin your workday.

### Bad-File Crisis

It doesn't take much for a file to go bad. One magnetically zapped bit of data can cause enough damage to render a whole

file unopenable. In reality, though, most of the data trapped in a corrupted file is probably OK and can be recovered—if you can get to it. So if a file refuses to open when double-clicked, or crashes your program whenever you try to launch it, you may still be able to pry it open using another program such as a word processor to recover text.

For example, if a QuarkXPress document won't open because of corruption, you can force it open with Microsoft Word. Launch Word, use the Open com-

*continues*



mand, and change the List Files Of Type pop-up menu to All Files. Select the QuarkXPress file, and open it. You'll see a lot of garbage, to be sure, but in the file, amid the rows of garbage characters, you'll see every word of text contained in the document. Rescue it by copying and pasting it back into QuarkXPress.

For even more-effective text recovery, use a tool such as the \$29 RescueTxt, from Abbott Systems (914/747-4201, www.abbottsys.com), an indispensable utility for searching for lost text. RescueTxt reads disks directly, completely ignoring the Mac OS's file system. In other words, it sees everything on your disk—including files that you've trashed—block by block. Recovering text in this way can be tedious, but if you're desperate, RescueTxt can retrieve a name, a phone number, or a brilliantly constructed sentence that would otherwise be lost forever. (Abbott Systems' \$39 CanOpener is an even more powerful text-recovery tool that has gotten me out of many a difficult situation.)

### Bad-Disk Crisis

When a disk comes up as "unreadable," don't panic. Unreadable disks usually contain readable files; it's just the disk's directory information that's become scrambled. In other words, the map that the Mac uses to locate specific files on the disk is gone—or at least is mangled. Without a directory map, your Mac loses track of what files are on the disk and decides that it's unreadable.

Your first line of attack should be to run Disk First Aid, the free repair utility that came with your Macintosh (it's either on your Disk Tools disk or your system software CD-ROM). Disk First Aid isn't as powerful as other, commercial disk-repair programs, but it can repair minor directory glitches and, at the very least, let you know if a more serious repair is necessary (see "Free First Aid"). To fix major glitches, you might need a program such as Symantec's Norton Utilities 3.5 (\$99; 310/453-4600, www.symantec.com), which can fix disks beset with even major problems. (It can also retrieve files from disks that are so mangled that they can't be fixed.)

If your problem disk is a floppy, the solution may not even require a repair utility. Try ejecting the disk and reinserting it several times; simply reinserting the disk may take care of the problem. If



**Free First Aid** Disk First Aid isn't a powerhouse application, but it can verify and make minor repairs on uncooperative hard disks and other storage media, including floppies and removable media.

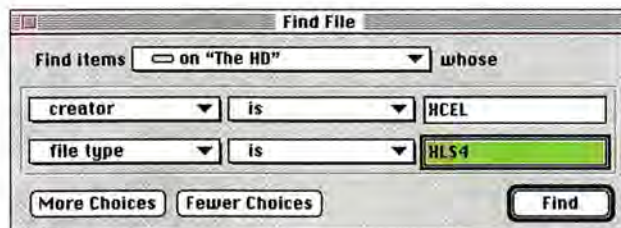

**Breaking the Code** To reveal a file's hidden type and creator codes, drag the file to the Find File window. Armed with these codes, you can use ResEdit to restore a file that's lost its identity.

not, take a close look at the disk. Is the metal shutter even slightly bent or out of line or a bit sticky? That's enough to cause the Mac to reject the disk. The solution? Just rip the metal shutter off and pop the disk into your Mac without it; it'll work just fine. Of course, the mangled floppy, with its Mylar platter exposed, can no longer be used for reliable storage, so copy the files you need from the disk and then get rid of it. You've lost a floppy but saved your files—and possibly your workday.

### Unknown-Application Crisis

You've probably seen this: A standard document, such as a Microsoft Excel file, suddenly stops looking like an Excel file in the Finder, its original icon replaced with a generic document icon. When you try to launch this file, you don't get Excel; you get a message that says the document could not be opened because the application program that created it could not be found. Or the Mac launches some other program completely—one that's not able to open the file.

What's going on? The file is suffering from type- and creator-code amnesia. Every file on your Mac is identified by a

four-character type code and a four-character creator code. These hidden codes tell the Mac what kind of file it is—whether plain text, PICT file, or QuickTime movie—and what program was used to create it. When these codes get zapped, as they sometimes do in a crash, a file essentially forgets what it is and where it came from.

There are a couple of ways to restore these codes. First, if a number of files on your machine have turned generic, try rebuilding the desktop. The desktop is the Mac's internal database that keeps track of all the files on your system and the icons that represent them. To rebuild the desktop, hold down the ⌘ and Option keys while restarting your Mac.

To fix type and creator codes on individual files, you can use ResEdit, Apple's free resource-editing program. Launch ResEdit, and then use the Get File/Folder Info command from the File menu to open the afflicted file. Type the correct codes in the Type and Creator fields, and then save the file. To be safe, it's a good idea to try this ResEdit solution on a copy of the file. If all goes well, you can throw away the corrupted original.

If you don't know the correct codes, first use ResEdit to open a normal file of the same type as the one you're trying to fix; you'll be able to see the codes. (These codes are case-sensitive, so copy them exactly as you see them.) Alternatively, you can drag a normal file onto the Find File window, with File Type and Creator selected as the search criteria; the codes will appear in the appropriate fields (see "Breaking the Code"). ■

JOSEPH SCHORR is the author of *Macworld Mac Secrets*, fourth edition (IDG Books Worldwide, 1997). He handles Mac crises and near-disasters on a daily basis for a trade-magazine publisher.



## Tips, Tricks, and Shortcuts

by Lon Poole

Already filled the bottom of your Mac OS 8 desktop with pop-up-window tabs? Or got a pop-up window with a wide tab due to a long name? Steven M. Alper (Jackson Heights, New York) has discovered an

easy way to shrink tabs. Grab a tab you'd like to shrink, and drag it up until its pop-up window becomes a regular window. Now position some remaining tabs about 1/2 to 1/4 inch apart. Click on the title bar of the window you want to make a pop-up with a shrunken tab, and drag it between the two tabs until you see it change to the outline of a tab. Although this outline shows the full tab width, when you release the mouse button, the tab shrinks to fit the space available. The tab remains shrunken if you drag it to a new position along the bottom of the screen.

You can adjust the position of any tab (shrunken or full-size) relative to its window by opening the window and dragging the size boxes at the top left and right corners. The tab stays put as you move its window beneath it.

### Grandfather Patterns

Q After I upgraded to Mac OS 8, my favorite desktop pattern (the yellow/green airbrush look) still adorns my desktop but is not part of the set of patterns available in the Desktop Pictures control panel. I would like to experiment with this control panel, but I don't want to lose my favorite pattern. I know this pattern exists somewhere on my PowerBook's hard disk. Where is it? And how can I store it permanently, for easy access?

MONTE ABRAMSON  
New York, New York

A Patterns that were included with system-software versions prior to Mac OS 8 are collected in a Scrapbook file named Additional Desktop Patterns on the Mac OS 8 CD-ROM (in the CD Extras folder). You can open this file in the Scrapbook by double-clicking on the file. If you have any trouble opening the file, drag it to your hard disk and double-click on it there. Then, with the Desktop Pictures control panel open, you can drag patterns (or copy and paste them) one at a time from the Scrapbook window to the Desktop Pictures window.



The pattern you want to preserve is in the Additional Desktop Patterns file, but if it weren't, you could still preserve it by using Apple's free ResEdit program (available from [www.info.apple.com](http://www.info.apple.com)). You can use ResEdit to copy the current pattern from the System file or any pattern from the Desktop Patterns Prefs file, where available patterns are kept in System 7.5 through Mac OS 7.6.1. (The Desktop Patterns Pref file is moved to the Trash the first time you use the Desktop Picture control panel in Mac OS 8. If you've un-

knowingly deleted it, get a copy from someone still using Mac OS 7.6.1 or earlier.)

After copying a pattern with ResEdit, you can paste it into the Desktop Pictures control-panel window.

Start by making a copy of your Desktop Pattern Prefs file or your System file and opening the copy with ResEdit. In the resulting resources window, double-click on the ppaf icon to display a window of patterns stored in the file. Select a pattern you want to make available in Mac OS 8, copy it, switch to the Desktop Pictures control panel, and paste. Repeat this

procedure with as many patterns as you want to copy.

### Beyond SimpleText

Q Often I can't open a document downloaded from the Internet because the document is too big for SimpleText. Even increasing SimpleText's memory size tenfold doesn't help. Why is this, and how can I circumvent this problem?

JOSEF HUEBER  
Ingolstadt, Bavaria, Germany

A SimpleText opens text documents with the help of the Mac OS's text-editing services, which max out at 32K.

You can open a jumbo text document by using the Open command within a word processor or text editor such as Microsoft Word, ClarisWorks, Corel WordPerfect, Nisus Writer, Tom Bender's \$10 Tex-Edit Plus shareware, or Bare Bones Software's BBEdit Lite freeware. Or, drag the document icon onto the application icon in the Finder. Applications that support Macintosh Drag and



Drop also let you open text documents by dragging the document icons into the open application window.

These techniques also work with Web browsers, but often with unsatisfactory results. Netscape Navigator and Communicator don't wrap lines to form paragraphs, and Microsoft Internet Explorer ignores line breaks altogether.

Another method is to change the document's creator application in order to have an application besides SimpleText open a double-clicked text document. You can do this using AutoTypers, tiny utilities that execute custom-specified actions, which you can create with the MakeAutoTyper program, included with Daniel Azuma's \$10 FileTyper shareware.

A text document dragged onto a suitably configured AutoTyper icon will, for example, change into a Microsoft Word document. Thereafter, the document will open in Word when double-clicked.

A free collection of seven preconfigured AutoTypers called "Change Text Creators" is included with our online shareware offerings.

### Inherited Attributes

**Q** Is there a way to make the Always Snap to Grid option the default behavior for Mac OS 8's View Options command? So far I've had to set this option separately for each folder, which is a hassle. I definitely prefer the old behavior (the now discontinued Views control panel). Am I stuck with this new feature, or is there a way around it?

DAVE TOWNSEND  
via Macworld Online

**A** One solution is to take advantage of the fact that copies of a folder—in this case, copies of an empty folder—have the same view options as the original folder. Create a new folder, open it, and use the View menu to set its view as you wish. Then duplicate the empty folder (⌘-D or option-drag) on the same disk as an old folder whose view options you want to change, and drag the old folder's entire contents (⌘-A to select all) to the duplicate empty folder. If you drag from an old folder that contains icons you've hand-placed in a particular order, you should open the destination folder and drag all the icons as a group to the destination folder's window rather than to the

folder's icon. This preserves the icon ordering as much as possible (the view options set for the destination folder may forcibly reorder the icons). Finally, copy the name from the old, now empty folder, trash the old folder, and paste the name on the replacement folder. Repeat with a new duplicate of the empty folder for each old folder that you want to have the same view options. This procedure is still a lot of work but less so than applying multiple View commands to each old folder.

A second approach is to use the \$10 shareware Finder View Settings, by Alessandro Levi Montalcini. You can use it to override all folder-specific view options in Mac OS 8 or to change the view options for a batch of folders.

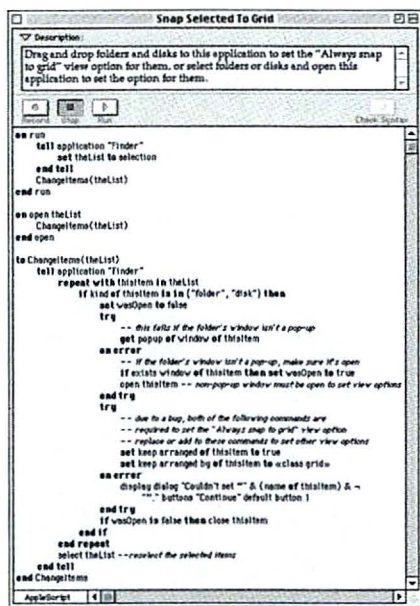

**Scripted View Options** This AppleScript script applies the Always Snap to Grid option to the currently selected folder and disk windows. You can type the script into the Script Editor program and save the script in the Automated Tasks folder, setting the Kind option to Application and turning on the Never Show Startup Screen option in the Save dialog box. Then you can use the script by choosing it from the Automated Tasks submenu of the Apple menu.

Another approach is to use AppleScript to set a folder's view options, as shown in the example AppleScript applet (small application) in "Scripted View Options." In addition, Apple distributes a more complex AppleScript that copies the view options of a folder to the folders inside it and optionally to all nested folders. This applet is part of a package you can get from Apple's AppleScript Web site

([http://applescript.apple.com/applescript\\_overview/utility\\_scripts/UTILITY\\_SCRIPTS.00.HTML](http://applescript.apple.com/applescript_overview/utility_scripts/UTILITY_SCRIPTS.00.HTML)). The AppleScript Web site also has a lengthy technical discussion about scripting all view options, including a listing of the aforementioned AppleScript applet ([http://applescript.apple.com/applescript\\_overview/system8/container\\_windows.00.html](http://applescript.apple.com/applescript_overview/system8/container_windows.00.html)).

### Absolute Reference

**TIP** When creating or editing a formula in a ClarisWorks spreadsheet, you can enter an absolute reference to a cell by ⌘-option-clicking it. For example, ⌘-option-click cell A1 to enter \$A\$1. (If you copy and paste a formula or use the Fill command to replicate that formula, absolute references in it don't change in the same way that relative references do.)

HALIM NGAH  
Kuantan, Malaysia

### Italic Jaggies

**TIP** Ever notice that the italic style of some fonts looks very jagged on screen but smooth when printed? This happens if there's an italic TrueType (or PostScript) version of the font but no equivalent italic bitmap version. The same sort of problem can affect bold and other styles on screen. For example, the Times font suitcase that comes with the Mac OS contains several bitmap sizes of plain Times together with plain, bold, italic, and bold-italic TrueType Times.

You can improve the appearance of styled text on screen simply by opening the font suitcase (in the Fonts folder) and dragging the bitmap fonts to a folder outside the System Folder. You can tell the bitmap version from the TrueType version by the icon; the icons for the bitmap versions contain only one letter A, whereas those for TrueType fonts have three As. The Finder makes you quit all open applications before you remove fonts from the Fonts folder or from suitcases inside the Fonts folder.

Once you restart the applications, you can take advantage of the new italic versions of the fonts. This tip is especially good for Web surfers—the italic text used on many pages will actually be legible!

RANDY GLENN  
Oakville, Ontario, Canada



## Better Fax Display

**TIP** To display on-screen faxes more legibly, the Global Village Fax Center software (bundled with the Global Village TelePort and PowerPort modems) uses a moderate amount of antialiasing. While the preset amount is fine nine times out of ten, text is too blurred in some instances to be legible or more antialiasing is necessary. I've discovered that in these situations, there's a way to increase or decrease the contrast: simply use the up- and down-arrow keys. Changing the antialiasing does not affect GlobalFax OCR's ability to recognize text, nor are the changes reflected in printed copies of faxes.

JONATHAN COWPERTHWAIT  
Oakland, California

## Web-Page Typography

**TIP** In "Improving Your Web Typography, Part 1" (*Media*, September 1997), Jim Heid mentions using the new `<font>` HTML tag for better font control on a Web page. As a Web-site designer, I find that one of the most interesting uses of `<font>` tags is to combine them with `<pre>` tags for preformatting text. Most designers make little use of `<pre>` tags, because although they give precise text layout, they also result in the text's being displayed as a monospaced font (boring!). But by combining the `<pre>` and `<font>` tags, you preserve both layout and font control. You simply put the `<font>` tags inside the `<pre>` tags, like this: `<pre><font face="Arial, Helvetica">Text goes here </font></pre>`.

DAMEON ROLLINS  
via Macworld Online

*Jim Heid agrees that this is a cool tip. It lets you control line breaks and spacing simply by typing spaces and hard carriage returns—no need to use codes such as `&nbsp;` and `<br>`. It seems to work fine with Navigator 3.0 and Internet Explorer 3.0.—L.P.*

## More System Fonts

**TIP** You can modify the Appearance control panel to use any font you have installed in your system for menus, dialog boxes, window titles, and so forth. Use ResEdit to open a copy of the

Appearance control panel, and then open its MENU resource -4050 (which is initially empty). Choose Create New Item from the Resource menu, and for the new menu item, type the name of an installed font. Save your changes, and close the copy of the control panel. In the Finder,

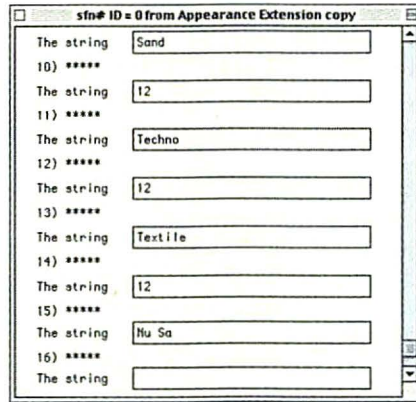

**Add a System Font** You can add a font to the system font pop-up menu in the Mac OS 8 Appearance control panel by using ResEdit to modify the sfn# resource ID 0 in a copy of the Appearance extension file. To make the job easier, open the sfn# resource with ResEdit's Open Using Template command and specify the STR# template. Type the additional font name and size in two new fields.

substitute the modified control panel for the original. Now open the modified control panel, choose the system font from its pop-up menu, and restart. Voilà!

PAUL MCGRANE  
Livingston, New Jersey

*The font you add must be a TrueType font or have a 12-point size installed. And for best results, it should include the special characters that represent the `⌘` key, the shift key, and so forth (a number of fonts don't have these). Also, this method causes the Appearance control panel's pop-up menu to display incorrectly, although it still works.*

*One possible system font to use is Marty Pfeiffer's free Virtue font ([www.teleport.com/~wamozart/fontware.html](http://www.teleport.com/~wamozart/fontware.html)). Virtue looks like Charcoal but has looser letterspacing like Chicago's, and it comes with an application that patches the Appearance extension (not the control panel) to properly list the font in the system-font pop-up menu.*

*Another possibility is to use Pfeiffer's \$10 shareware Nu Sans Bold 12, which is a clone of the Espy Sans Bold font used for headings and titles in Apple Guide windows. You can get the genuine Espy font from the Apple Guide extension and other places. However, there's little*

*point, because unlike Nu Sans, the real Espy is unable to display key-cap symbols such as `⌘` in menus.*

*Other system-font candidates include Espi Sans Bold 10 (like Espy), Tecton (like Adobe Tecton), and Veritas 12 (like Charcoal). They're all tweaked for system-font duty and are included with the Kaleidoscope shareware by Greg Landweber et al. ([www.macdownload.com](http://www.macdownload.com)). In fact, you can use Kaleidoscope to change the system font to any installed font and size.*

*If you don't want to add the Kaleidoscope control panel, which modifies your system software during startup, you can add fonts to the Appearance control panel's pop-up menu by using ResEdit to modify the standard Appearance extension file (not the Appearance control panel). With this procedure, the system-font pop-up menu displays correctly.*

*First make a copy of the Appearance extension and open the copy with ResEdit. Next open the sfn# resources icon. Choose Open Using Template from the Resources menu, and in the dialog box that appears, specify the STR# template. This opens the sfn# resource ID 0 with the STR# resource template. This resource already includes the Charcoal and Chicago fonts plus the following mystery fonts: Cbisel, Gadget, Sand, Techno, and Textile. Scroll past all of these fonts to the bottom of the window, click on the last set of asterisks, and choose Insert New Field twice from the Resource menu. This adds two fields to the resource, as shown in "Add a System Font." In the first new field, type the name of the font you want to add, and in the second new field, type the size of the font (use 12-point for best results). Save your changes, and quit ResEdit. Substitute your modified Appearance extension for the original, and restart your Macintosh.—L.P. **m***

LON POOLE answers readers' questions and selects reader-submitted tips for this monthly column. His latest book is *Macworld Mac OS 8 Bible* (IDG Books Worldwide, 1997).

Shareware mentioned in *Quick Tips* is available from Macworld Online ([www.macworld.com](http://www.macworld.com)) or America Online (keyword Macworld; use keyword Apple for Apple software).

We pay \$25 to \$100 for tips on how to use Macs, peripherals, or software. Please include your full name and address, so that we can send you your payment. Send questions or tips to [quicktips@macworld.com](mailto:quicktips@macworld.com) or to Macworld Quick Tips, 501 Second St., San Francisco, CA 94107. All published submissions become the sole property of *Macworld*. Due to the high volume of mail received, we cannot provide personal responses.



# Publishing Workshop

## How QuarkXPress 4.0 Will Change Your Life

by David Blatner and Galen Gruman

When people start talking about the big “four-oh,” they usually look down in the mouth (unless it’s someone *else’s* birthday). However, the long-awaited 4.0 version of the world’s most popular page-layout program is truly cause for celebration.

Though the engineers at Quark stripped down the program and completely rebuilt some parts of it for this release, at first glance it’s still the same program you know and love. Quark’s makeover includes general interface enhancements (such as tabbed dialog boxes and more keyboard shortcuts) and two basic types

of new features—artistic tools (illustration, image enhancement) and structured-document tools (indexing, tables of contents, multichapter books). Quark rounds out this version with dozens of small additions that add up to major workflow and productivity gains.

This month, we explore some of the most important new features, looking at how they affect the way you do your job. We even throw in some fun tips and tricks for getting the most out of the older-but-wiser XPress.

### Bézier Curves

The most exciting new feature in QuarkXPress 4 is the ability to draw Bézier curves. This does *not* mean that XPress

now takes the place of Macromedia FreeHand or Adobe Illustrator; for heavy-duty illustration, you still need a dedicated illustration program. On the other hand, how many times have you avoided designs that put text along a curve because it’s just too much of a hassle to go back and forth between XPress and another program to make changes? Now you can place text along a curve right on your page; apply any of XPress’s typographic formatting to it, including style sheets; and edit it to your (or your client’s) heart’s content.

While you may not be doing heavy-duty illustration, the drawing tools in XPress 4 are certainly powerful enough

for building simple logos. Once you’ve made one, you can even save it as an EPS file to use in other programs. A Bézier curve can be either a line or a box. If it’s a line, you can put text along it; if it’s a box, you can put either text or a picture inside it.

### Character-Level Styles

The second most “life-changing” feature in QuarkXPress 4 is character-level styles. For anyone unfamiliar with the concept, a style sheet is a collection of text formatting—font, size, leading, indents, color. There are two great things about style sheets: They let you apply a bunch of formatting with one keystroke or click, and they let you change

## Text Wrap

Sometimes, floating small graphics as accents in a sea of text is the perfect way to give a layout some panache. The only problem: Earlier versions of QuarkXPress limited text wraps to one side of a graphic. Version 4 lets you run text on all sides.

1. To wrap text on all sides, you have to go to an odd place: Select the text box, and choose Modify from the Item menu (⌘-M). Go to the Text tab, and check Run Text Around All Sides. (You have to set this only once, even if there are multiple items sitting on top of the text box.)
2. Now, press OK, select the foreground object (the one causing the runaround), and go to the Runaround dialog box (⌘-T).

**TIP** When you’re flowing text around an element, it helps to see how the lines break around it. XPress 4.0’s Live Refresh feature makes that easy. In the Application Preferences dialog box’s Interactive tab (⌘-Y), turn on the Live Refresh check box. Now, when you drag the foreground object or change the

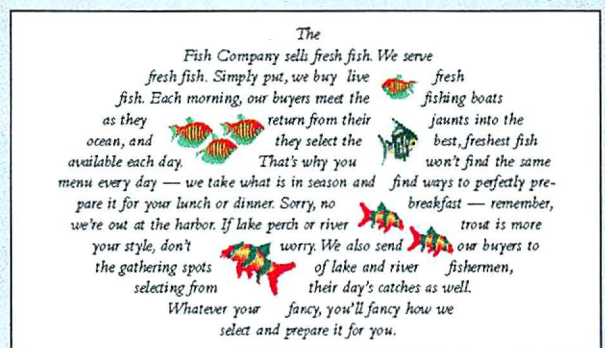

text box’s size, wait a half-second after pressing down the mouse button before moving the mouse. The pointer changes to the  symbol; now the text wrap changes as you drag the picture box.



# Shape Your Text

It used to be that you needed Adobe Illustrator or Macromedia FreeHand to create text effects and then export them in EPS format for use in QuarkXPress. No longer. With XPress 4.0, you can make text align to any path—whether a Bézier curve or a straight line. In addition to making text follow a shape, you can even turn text into a shape.

## Follow That Path

1. Create a path using one of the four text-on-a-path drawing tools—Bézier, standard line, orthogonal line, or freehand tool.

**TIP** You can move tools you use often from their pop-up into the main Tool palette. Press control when selecting the tool. Control-clicking on a tool in the regular palette puts it back in its original pop-up menu.

2. Click on the Content tool, and then click anywhere on the text path. Start typing.

3. Format your text as you would any other text.

**TIP** You can put text on any path. Select the path, go to the Item menu, and choose Text from the Content submenu.

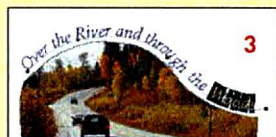
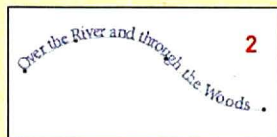
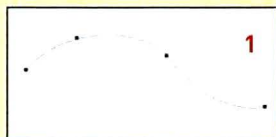

## Follow That Shape

To have text run around a box's shape, create a box by using any of the box tools. Then in the Item menu choose Shape and select the squiggly-line icon, which converts the box into a closed path. Now use Item → Content →

Text to convert the path into a text path. If you want text to run around a box's contents, do the preceding steps on a copy of the original box and place that copy on top of the original box.

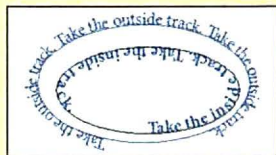
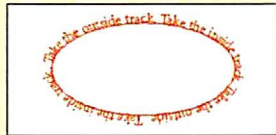

## Now It's Inside, Now It's Out

To get text inside a path (rather than outside the path, which is the default), Choose Flip Text from the Style menu (or click on the Flip Text icon in the Measurements palette).

## Now It's Text, Now It's a Box

1. Select anywhere from one character to a full line of text—but no more than one line—with the Content tool. In the Style menu, choose Text To Box to convert the text to a picture box.

2. You can now scale the box like any other box and bring a picture into it. Convert it to a text box, and you can even add text inside your text. Note that even though these letters don't touch, they form a single picture box.

**TIP** To break out letters as individual boxes, convert each letter separately. If you've already converted a group of letters and they don't touch, you can still split them apart. In the Item menu, choose Split → Outside Paths.

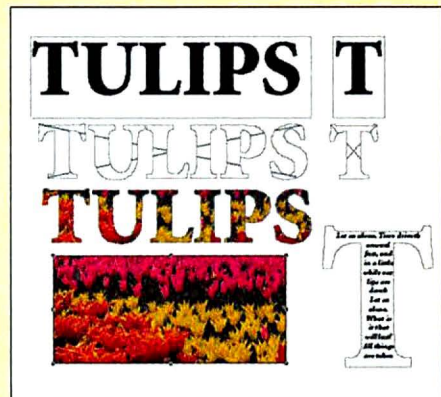

that formatting simply by changing a style sheet's definition. Up to now, a style sheet always affected an entire paragraph. The ability to apply styles on a character-by-character basis is a major leap forward.

You can easily apply separate styles to elements *within* a paragraph: run-in subheads, drop caps, even sentences or words in the middle of a paragraph. If you want every instance of a company name in a brochure to be 12-point Palatino bold, for example, you can apply a character-level style sheet to those words. If you don't like that look, changing the style sheet's definition reformats those words throughout your document.

Even better, Quark has expanded the regular Find/Change dialog box so that you can search and replace style sheets (both paragraph-level and character-level). For instance, if you want to apply a character style everywhere the phrase *new and improved* appears in your document, you can search for all instances of the phrase and automatically apply the style sheet from the Find/Change dialog box.

## Clipping Paths

For years people have gotten burned by putting TIFF images into picture boxes with a background of None. The result has always been icky jaggy edges. Quark heard the yelling and fixed it with a robust new Clipping dialog box. For images on a white or near-white background, XPress can build a clipping path for you. For a more complex background, you can create the clipping path in Adobe Photoshop. When you import the image as a TIFF file, XPress not only reads this embedded path but also lets you modify the path. Create multiple paths, and XPress will let you choose which one to display

*continues*



and print. You can even use clipping paths to extend part of the clipped image into the layout beyond the picture box.

### Long Documents

The long-document market—that is, folks who are creating books, magazines, and catalogs—will love three of XPress 4's new features: Books, Lists, and Indexes.

**Books** The Books feature lets you identify a group of documents to be treated as a single entity. You can automatically paginate the group so that page numbers run consecutively from the beginning of the book to the end, and you can print the whole thing at once. You can also synchronize the style sheets, colors, and other information among all the documents. The word *book* is misleadingly narrow—this feature is aimed at anyone who is creating manuals, documentation, and other multichapter projects.

**Lists** At first glance, Lists appears to be just a table-of-contents generator, but it does more than that. It lets you create any sort of list, based on the style sheets you use. You can create, for example, a list of all tables (by creating a unique style sheet for table titles and applying it to each one), an outline (by capturing all the heading styles), a list of headlines, a list of figures, every instance of a footnote, and more. If you can tag it with a paragraph style sheet, you can capture it in a list.

Once you have defined your lists (in the Edit menu, choose Lists), you can generate one with the Lists palette (option-F11). Choose the list you want to generate, position the pointer in the text box where you want to add the list, and then click on the palette's Build button or Update button as appropriate. Note that the page numbers are based on what was true when you gen-

erated the list; if you change your document, you must rebuild the list to get the new page numbers.

**Indexes** XPress 4 handles indexing through an XTension that ships with the product (if you don't need indexing, you can turn it off with the new XTension Manager feature).

To create an index, use the

Index palette (in the View menu, choose Show Index). As you go through a document, highlight each word or phrase to be indexed and click on the Add button (red brackets appear on screen around the indexed text). The Scope pop-up menu lets you extend the index to the end of the paragraph, to the occurrence of a

specific style sheet, or for a specified number of paragraphs. Scope lets you create index references that traverse a range (for example, "Macintosh, pp. 41-43").

You must index each occurrence of a word or phrase you want your index to include—XPress will not search them out for you. However, you can add words or phrases to the index, even if they don't appear in the document (for instance, you might want entries for *fish sticks*, *popsicles*, and *ice cream* to appear in the index under *frozen foods*, even if that phrase never appears in the text). You can check to see if you used more than one variation of a word (such as *Mac* and *Macintosh*), by scrolling through the palette's list of indexed terms. You can create an index from multiple documents if they're defined as a book, make "see" and "see also" cross-references within an index, and format the text in the index automatically, too.

If you click on the hierarchy triangle to the left of a term, you can see a list of all the pages on which the word or phrase has been indexed. When you're finished with the index, select a text box and in the Utilities menu, choose Build Index to create the actual index.

### Color and Printing

Quark is solidifying its position in the color prepress world with XPress 4's color and printing features. The most important of these is the ability to mix spot-color inks into *multi-ink* colors. If you are printing a two-color job with black and red, you can make it appear to be a three-color job by overprinting tints of red and black to form a dark red. It's always been a hassle to create this kind of effect, and you could almost never see a preview of the mixed color on screen. XPress 4's multi-ink feature makes it easy to create

## Add and Subtract Shapes

Gaining access to illustration tools doesn't suddenly make you an illustrator. Fortunately, QuarkXPress 4 lets you build complex objects out of simpler ones by using the Merge commands.

There are seven Merge commands in the Item menu; each lets you add or subtract two or more items on your page.

**Intersection** deletes everything except the parts that are overlapping the farthest-back object.

**Union** groups selected objects into a single object.

**Difference** acts like a cookie cutter—it cuts out the overlapping object's shape from the background object.

**Reverse Difference** is like a cookie cutter, too, but this time XPress cuts out the background object's shape from the foreground object.

**Exclusive Or** combines all the shapes, but it cuts out the parts that overlap each other (this is sort of the reverse of Intersection).

**Combine** is visually identical to Exclusive Or, but where Exclusive Or places corner points at all the intersection points, Combine does not. We often find Combine more useful.

**Join Endpoints** does just what it sounds like. The open endpoints of two lines (curved or straight) must be close to each other for this to work properly.



Original shapes

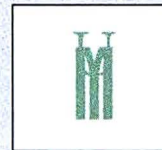

Intersection



Union



Difference

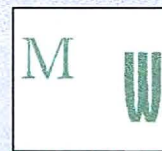

Reverse Difference



Exclusive Or



and preview these colors.

Mixing colored tints increases the possibility of moiré patterns at print time, so the fact that Quark has significantly revamped the Print dialog box comes as a pleasant surprise. Not only can you print noncontiguous pages (such as 1, 4, 6–8, and 13) but you can also specify halftone settings for each color individually, preview how the page will print, and save sets of Print dialog-box configurations for reuse. Plus, the Page Setup dialog box and the Print dialog box are now two tabs in one dialog box, so it's faster to go back and forth between the two.

If it's the cutting edge you want, you can get that from XPress, too, as it includes Pantone's Hexachrome HiFi color sets (don't forget to pick up a Hexachrome swatch book

from Pantone so you can see what these colors look like in print). Hexachrome is a six-color printing process that allows you to achieve some bright colors that you cannot get in normal CMYK printing. Although this is kind of cool, most people will never use it, because HiFi color adds to the cost of the job and does not help the quality of most images.

The great color news of the day is that Quark dropped the EfiColor XTension and now ships XPress with the Quark CMS XTension, based on Kodak's Color Management System and Apple's ColorSync. It's a better-implemented system and provides superior color quality. However, color management is not currently (and may never be) easy; to use the Quark CMS properly is going

to take some hard work and some education.

### Little Changes Make a Big Difference

While there are some really big changes in QuarkXPress 4, there are also some smaller, subtler changes that will nevertheless have a significant impact on your working life. One of the coolest little changes is that you can now use either the Item tool or the Content tool to import pictures into a box. In fact, in most cases, it no longer matters which tool you use (you can even select multiple objects with the content tool). Here are some others:

- Zoom to 800 percent view. This is great when you care a lot about your kerning.
- Make your own dashes and stripes. This built-in feature

lets you augment the ones that come with the program. These are true PostScript elements, so they look good in print at any size.

• Append elements to documents. The File menu's new Append command lets you bring style sheets, colors, lists, or custom dashes or stripes into your document from another file, even if that file is closed. And you can now select which elements to import—it's no longer all or nothing.

• Interactively scale multiple objects simultaneously. Just group them (⌘-G) and then ⌘-option-shift-drag one of the corner handles of the group.

• Create truly empty boxes. XPress now offers None as a box type. Unlike "empty" text and picture boxes, None boxes

*continues*

## Guided Tour of Clipping Controls

Designers love to snatch objects from a photographic background and plopping them down in the middle of a page. It's a fanciful effect that used to require a lot of tedious work. QuarkXPress 4.0 offers much more flexible ways to work with clipping paths; it'll even do some of the tedious stuff for you. You do most of the clipping work in the Modify dialog box. Select an image, and choose Modify (⌘-M) in the Item menu.

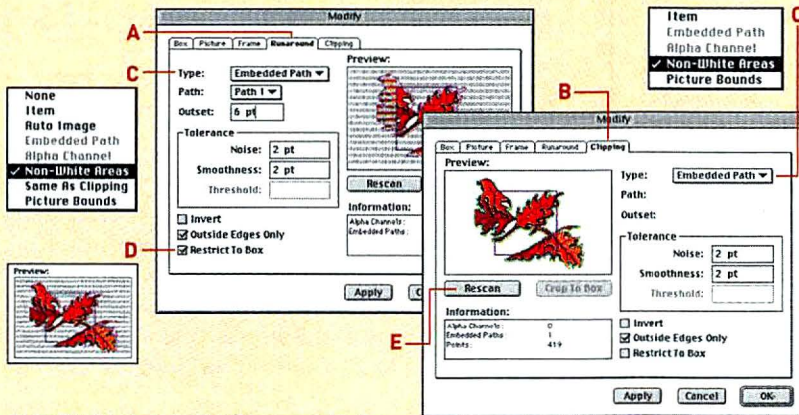

- A.** ⌘-T takes you to the Runaround tab.
- B.** ⌘-option-T gets the Clipping tab, where you do your fancy text-wrap work.
- C.** Choosing the Non-White Areas option tells XPress 4 to ignore areas that are white or nearly white (increase the Threshold settings for off-white backgrounds).
- D.** Uncheck Restrict To Box to display portions of the image that extend beyond the box's current boundaries. XPress can then wrap text around the invisible parts of the image, not just the visible parts.
- E.** If you make changes to a clipping path but you don't like them, click on Rescan to reinstate the original path.

### Clip Tips

- To create silhouettes or masks, import a TIFF file that contains nothing more than a clipping path.
- To save redraw time and avoid some potentially awkward wraps, check Outside Edges Only in the Clipping tab; this ensures that text stays on the outside of an image. Uncheck this option if you want text to fall within an image—for example, if you're wrapping text around a picture of a doughnut and you want text in the doughnut hole, not just around the outside edges.
- If you want your text to wrap around the image's embedded paths, be sure to set the Runaround option to Same As Clipping, so XPress 4 follows the Clipping tab's settings as it wraps the text.
- Fine-tune the clipping path in your layout. In the Item menu, choose Edit → Clipping Path (shift-option-F4), to make the path visible on screen. Now edit it as you would any Bézier curve in QuarkXPress.



don't contain anything, so they're perfect for solid-color backgrounds or shapes. They additionally keep the file size down.

- Interrupt screen redraw. In case your page is taking too long to draw on screen, XPress lets you interrupt the screen redraw with any click or by pressing ⌘-period. (Tip: To force XPress to resume redraw-

## Caution: Saving in 3.3 Format

QuarkXPress 4 includes the ability to save your documents in XPress 3.3 format. While this sounds like a great thing to anyone who has to work with people who are slow to upgrade, it has the potential to make your life miserable. Many of the cool new features in XPress 4 disappear when you save the file as an earlier version. Bézier curves become straight-line polygons; text on a path is straightened out and converted to a normal text box; custom dashes default to normal straight lines; character style sheets disappear (though the text style remains as local formatting); multi-ink colors become RGB colors. In other words, if you use any of the new features, this backward compatibility is disastrous to your work.

Oddly enough, if you save in 3.3 format and later bring the document back to version 4, some features do survive, notably the index entries. So, while it's great that Quark included this feature, you should use it with care.

ing, press ⌘-option-period).

- Unlimited tab stops. If you make a lot of tables, you'll be happy to know that you can make as many tab stops in a paragraph as you want. Quark is working on a table-creating XTension. Similarly, Tableworks (formerly Npath Software, 425/392-7745, www.tableworks.com) is readying an upgrade, called Entable, to its popular Tableworks table editor that takes advantage of the new tab features.

## Always Room for Improvement

Fortunately, while QuarkXPress 4 has the potential to significantly better your page-layout work, it's not going to take too long to learn, because most new features meld seamlessly into the interface that you already know and love. There are many features we'd love to see added to QuarkXPress (for example, basic Web-export capabilities), and some old ones could stand improvement (the interface in the Space/Align dialog box is still horrible, for instance, and the Measurements palette pales in comparison to Page-Maker's). Why didn't Quark implement fully functioning contextual menus? And why does XPress still lack a Layers palette?

All in all, this upgrade is a success. It may have been a long time in the making, but now at last we can see why. Some upgrades focus more on adding 3-D buttons and useless bells and whistles. With XPress 4.0, Quark added true functionality that really affects the way you work. ■

DAVID BLATNER is the author of *The QuarkXPress Book*, fifth edition (Peachpit Press, 1997), and other books. You can reach him at david@moo.com. GALEN GRUMAN, *Macworld's* editor, is coauthor of *Macworld QuarkXPress 4 Bible* and *QuarkXPress 4 for Dummies* (both IDG Books Worldwide, 1997).

# Managing Character Style Sheets

Making a character-level style sheet in QuarkXPress 4 is simple, because Quark has changed the Style Sheets dialog box to accommodate both character-level and paragraph-level style sheets, although it may appear daunting. Here's an easy way to make a style sheet.

1. Format some text exactly as you want the character style to be. Remember that character style sheets can include only character-level formatting (color, font, size, tracking, baseline shift, and so on). Paragraph-level formatting (leading, indents, drop caps, horizontal alignment) works only in paragraph style sheets.
2. While the text is selected, open the Style Sheets dialog box (select Style Sheets from the Edit menu, or ⌘-click on any name in the Style Sheets palette) and choose Character from the New pop-up menu.

Specify which style sheets appear in this list.

Choose the type of style (Character or Paragraph) you want to create.

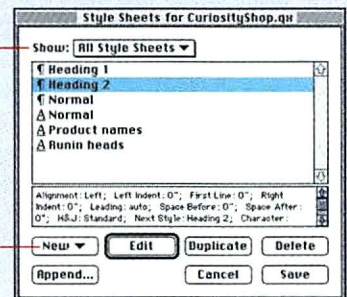

3. Give the style sheet a name. All the text formatting gets sucked into this dialog box automatically. You can still change it by altering the pop-up menus and check boxes in this dialog box.

4. Click on OK, and then click on Save.

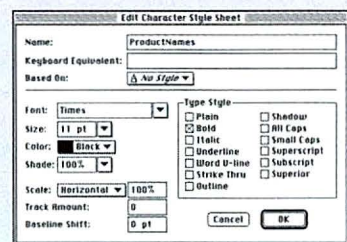

## Comparing Styles

If you've got two style sheets (either character or paragraph styles) that are similar, XPress can compare them for you. While pressing the ⌘ key, select both styles in the Style Sheets dialog box, and then option-click on the Append button (holding the option key down changes this into the Compare button). The program opens a new dialog box showing each style definition; the parts that are different are in bold.

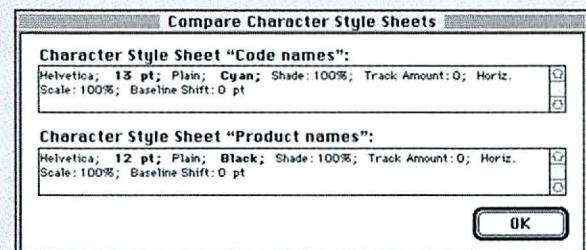





## IMAGINE BEING JUDGED ON YOUR IDEAS, NOT JUST YOUR COMPS.

Got a big idea? Well, even if you need it as a four-color, 11" by 17" bleed on 125 lb. tag board, we can help you make it pop. With any one of our big family of color printers — from our \$4,995\* Phaser® 300X to the new Phaser® 380 — you get the same vibrant photo-realistic Tektronix® color that satisfies the fussiest designers. See, if you can dream it up, we've got a way to get you there. To judge for yourself, call 1-800-555-1212 ext. 1512, or visit [www.tek.com/CPad?1512](http://www.tek.com/CPad?1512)



**Tektronix®**



# Graphics Workshop

## Easy Fixes for Common Image Problems

by Cathy Abes

**ARTIST** David Peters is a photo-illustrator based in Venice, California, whose clients include *Air & Space/Smithsonian*

and *Time*. Many of his Photoshop techniques find their way into his digital-illustration classes at Otis College of Art and Design in Los Angeles.

**HOW IT WAS DONE** Peters has found many of Photoshop's native filters useful for repairing imperfections such as dust, scratches, large-dot patterns, and banding in scanned photographs.

Here, he began by scanning a battered postcard that looked like it had been caught in a mail sorter. Peters first tackled the sky, using Gaussian Blur to soften the worst scratches and the dot pattern; he then blended most of the smaller scratches with Dust & Scratches.

Most effective for the less obvious scratches and dot patterns on the hula dancer's face, arms, and skirt was the application of Gaussian Blur, followed by the Median filter. Using Gaussian Blur alone would have oversoftened the image. Median sharpened the image without bringing back the dot pattern.

Peters then used the Crystallize filter to subtly diffuse the color banding (apparent only in CMYK mode) caused by the gradient fill in the blue circular background. The final step involved cloning out the small white chips that appeared along the background's edge—an unwanted side effect of the filtering process.

**TOOLS** **Hardware:** Apple Power Macintosh 9500/150 with 132MB of RAM, 2GB internal hard drive, and 1GB external hard drive; 1GB ProMax Iomega Jaz removable-cartridge drive; 21-inch NEC MultiSync XE21 color monitor; Microtek ScanMaker III color flatbed scanner. **Software:** Adobe Photoshop 4.0. **m**



**1** Flaws in the scanned postcard included scratches, scrapes, a large-dot pattern, and an uneven surface.



**2** After experimenting with Gaussian Blur at several lower settings, which didn't have enough effect, Peters finally settled on a 6-pixel radius to soften the scratches.



**3** Applying Dust & Scratches (a Noise filter) at a 6-pixel radius and a 12-level threshold blended most of the remaining smaller scratches, leaving only the worst surface flaws, which he would later clone out.



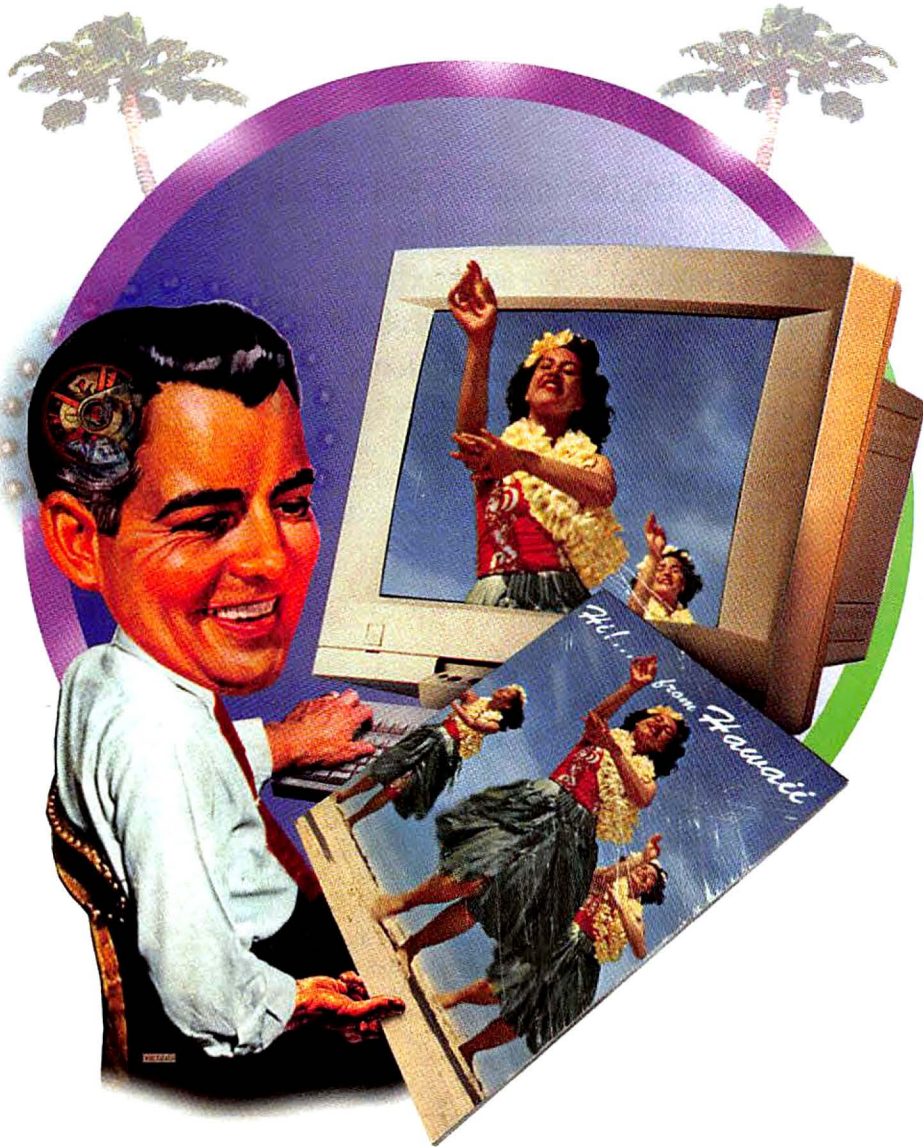

**7** To fix the residual “chipping” effect of applying the Crystallize filter in a selection, he reloaded the blue circular background selection and cloned from its center to remove the white chips at the outer edge.



**4** Blurring the smaller scratches and diffusing the dot pattern on the hula dancer was a two-step process. After drawing a rough-outline selection around the figure, Peters first applied Gaussian Blur with a 1-pixel radius.



**5** To sharpen the facial features without bringing back the dot pattern, he applied Median (another Noise filter) with a low, 2-pixel radius to a 6-pixel feathered selection of the hula dancer. (Although this filter brought back the larger scratches, it made them easier to clone out.)



**6** To fix the banding problem (apparent only in CMYK mode) caused by the gradient fill in the circular background, Peters applied Crystallize (one of the Pixelate filters) at a low setting (a cell size of 14).



# Create Labels, Barcodes and Mailing Lists in one easy-to-use program

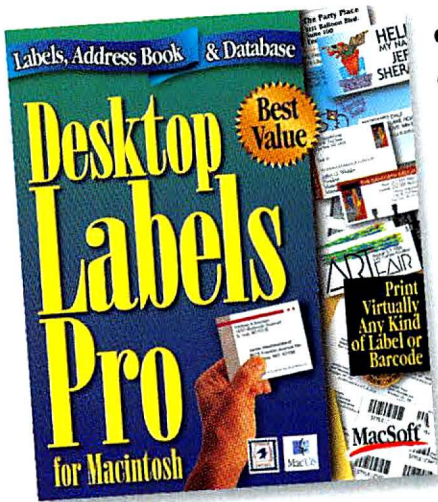

- Store Your Mailing Lists in the Powerful Database
- Design Professional Labels in Minutes
- Create Personalized Letters and Brochures
- Create and Print Virtually Any Kind of Barcode
- Flexible Graphics and Page Layout Tools

Create labels, barcodes, mailing lists, personalized form letters, tickets and more. Just design your label or document, enter or import your names into the database, and print. Create and customize your own professional labels or select from hundreds of built-in label formats. Whether you're printing one label or thousands, Desktop Labels Pro makes it easy.

**\$24.99**

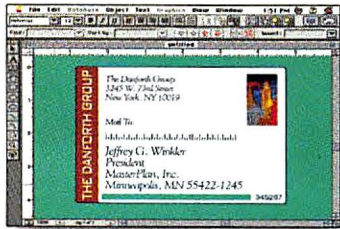

### Innovative Label Designer

Desktop Labels Pro gives you many of the same powerful graphics tools found in the best desktop publishing programs. You can design your own professional-quality labels in just minutes.

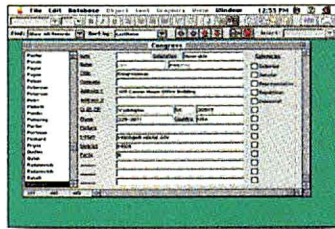

### Powerful Database & Address Book

Holds up to 32,000 names. The built-in database & address book makes it easy to enter names from your keyboard or import them from another program. Once entered, you can quickly find the names you want, arrange them in any order and print mailing labels using the built-in label designer.

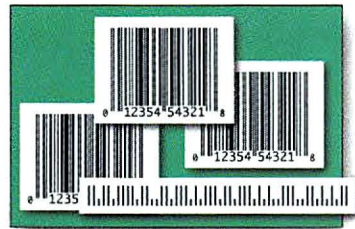

### Print Virtually Any Kind of Barcode

If you wish, Desktop Labels Pro will automatically print postnet barcodes on your mailing labels to help speed up post office delivery. Or, you can use Desktop Labels Pro to print virtually any kind of commercial barcode.

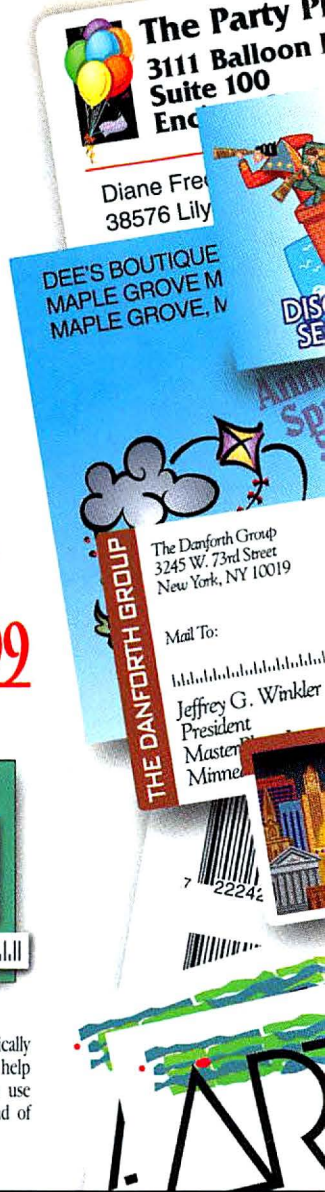

## Full-Featured Desktop Publisher

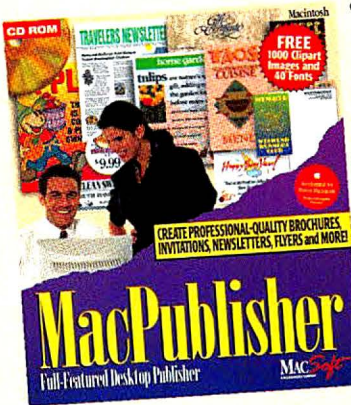

- Create professional-quality documents
- Built-in spell-checker
- 50 professionally-designed templates

Now you can work with the same desktop publishing tools used by the best graphic artists. MacPublisher gives you many of the same powerful page layout tools found in programs priced hundreds of dollars more. Create brochures, invitations, newsletters, flyers and more. Save time by using one of the 50 professionally-designed templates or you can create your own master pages. Draw graphic objects, or import them from any graphics format, and place them anywhere on your document. Powerful tools are just a click away!

- Place objects precisely where you want them
- Choose a color
- Select a style for any line or border
- Draw virtually any type of object
- Draw lines and arrows
- Draw arcs
- Rotate any object
- Make two objects the same size
- Flow text from one object to another
- Adjust the space between characters
- Adjust the space between lines

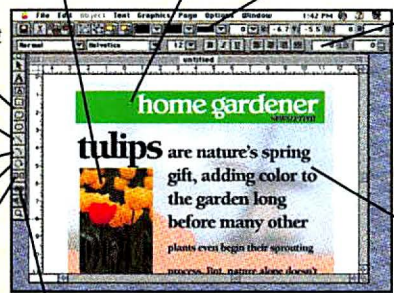

**\$24.99**

# MacSoft®

An Affiliate of GT Interactive Software  
2500 Berkshire Lane, Plymouth, MN 55441 612.509.7600

Available now from your favorite reseller  
or by calling

**800-229-2714**

Call for a free catalog or visit our website at [www.wizworks.com](http://www.wizworks.com)

Circle 39 on reader service card

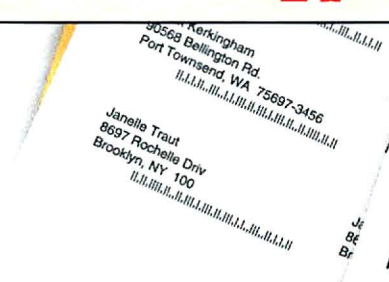



It's ALL TOO EASY to make the kinds of mistakes in typography that distract or mislead readers, make pages hard to read, or look sloppy and amateurish. Fortunately, you don't have to become a master typographer to avoid making such mistakes. You just need to be aware of what makes a page look bad and to know some manual adjustment techniques for fixing the errors. Here are ten of the most glaring errors and advice on how to keep them out of your pages:

## 1. Rotten Spacing

*Holes* (large spaces between words), poor *letterspacing* (obvious space between letters), *ladders* (more than three consecutive lines ending with hyphens), and awkward word breaks can ruin the look of a page. Here are some techniques to help you fix such problems:

By Kathleen Tinkel  
[graphicsuser@macuser.com](mailto:graphicsuser@macuser.com)

# 10 Typographical Blunders

Nobody dies of bad type, but it could lose you an important client

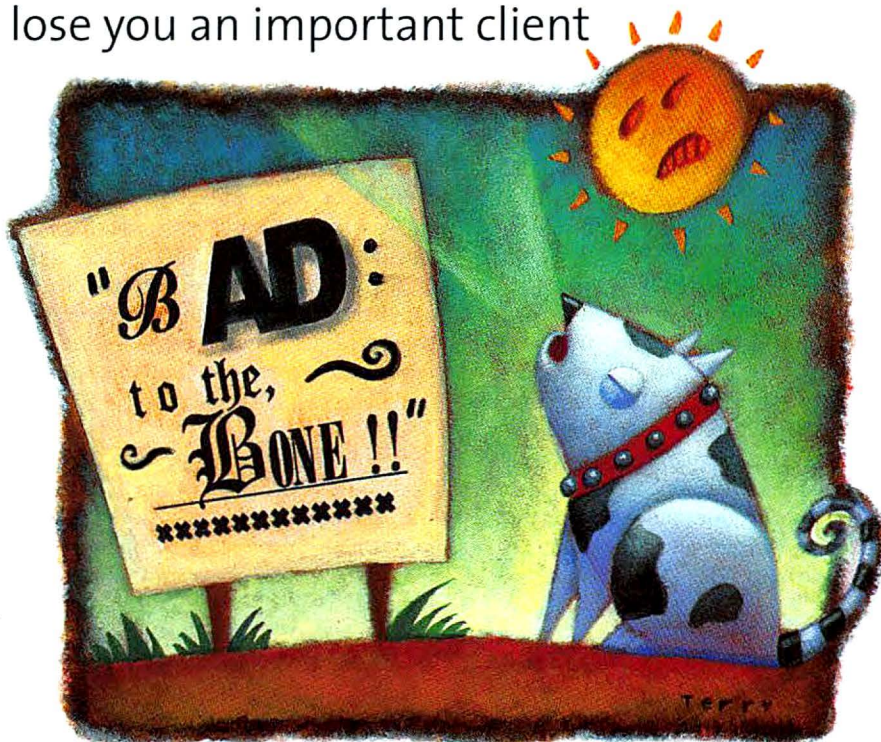

**Change software settings.** Changing the default space settings (hyphenation and justification) in your page-layout program can produce the most-dramatic improvement in spacing. Do this before making any other changes to your text. For specifics on changing settings in QuarkXPress and Adobe PageMaker, see the "Key to Better Spacing" sidebar.

**Edit the copy.** Assuming you're authorized to do this (or can get away with it), editing the copy is often the most elegant solution.

**Hyphenate manually.** Look for loose or tight lines before a problem line, and either break a word or push a broken-word stub down to the next line. To hyphenate manually in QuarkXPress, use ⌘-hyphen. In PageMaker, use ⌘-Shift-hyphen.

**Try a different font.** Some typefaces take up more space than others—for instance, 9-point Adobe Caslon fits about 10 percent more characters on a line than 9-point Utopia.

**Choose a smaller type size.** There are limits, of course—few typefaces are legible below 9 or 10 points.

**Make columns wider.** Do this with caution—wide columns make it easy to get good spacing, but it's more difficult to read wide lines. Also, wide columns of small type tend to look gray and forbidding. For typical copy, Adobe Caslon at 9/11 sets nicely in 18- to 20-pica lines and is tolerable in 11- or 12-pica lines.

**Don't justify.** Use ragged type instead whenever you can. If you set type flush left/ragged right instead of justifying it, word- and letterspacing are not altered at all. If you find the raggedness at the right margin too wild, you can fiddle with hyphenation to try to shape it more gracefully.

**Don't tamper too much.** Resist changing spacing between characters in unjustified text, even if you want to eliminate or pad a short line. Adding spaces only disrupts the naturally even typographic color of flush-left/ragged-right type. In fact, it's likely to produce an ugly striped pattern of light and dark lines or create nasty optical blobs in which parts of letters collide.

## 2. Typewriter Habits

You'll impress clients and create a better-looking page if you make sure you follow typographical standards rather than word-processing ones. For the most part, this



# GraphicsUser

means using the correct special characters, but you should also avoid a few type-writing habits.

**Mind your apostrophes and quotation marks.** Type designers create apostrophes and quotation marks to match the design features of a typeface's other characters—the tail of the *y*, the stroke of the *r*, serifs. Using generic typewriter marks, or “straight quotes,” instead of these complementary characters stamps work indelibly as amateurish.

**Use curly quotes.** If the curly quotes, also called smart quotes, function isn't already turned on in your page-layout software, you should turn it on (in many programs you can turn on smart quotes in Preferences; see your manual if you need instructions). With the smart-quotes option on, your software automatically produces typographic characters as you type double and single quote marks. PageMaker, QuarkXPress, and some other programs also include filters that convert the quotes automatically as you import text.

**Double-check apostrophes.** Even if you turn on smart quotes, you may still have problems with quotes. A program can insert an opening single quote when the correct character is a *leading apostrophe* (the first character in an abbreviation, such as *'tis*, or a truncated date, such as '98). Use the key combination Option-Shift-] to get the leading apostrophe character when you need it. (See figure 1 for an illustration of the difference between a leading apostrophe and an opening quotation mark.)

**Use real feet and inch marks.** Contrary to what you sometimes read, using typewriter marks for feet and inches is not typographically correct. The correct characters are in the Symbol font: for the foot mark, use the prime character (Option-4); for the inch mark, use the double-prime character (Option-comma).

**Don't underline or use all caps.** For

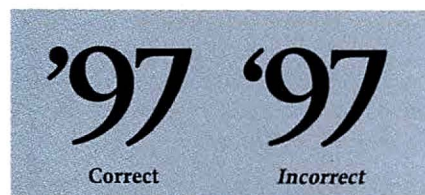

**figure 1 · Don't get caught using the wrong character in truncated apostrophes and dates. Always use a leading apostrophe, not an opening quotation mark.**

emphasizing words in text or for indicating the title of a book or movie, use italics rather than underscoring. (In fact, it's best not to underline for any reason—the feature doesn't work correctly in scalable fonts.) For more-dramatic emphasis—for instance, in headings and subheadings—use bold type rather than all caps.

**Use dashes, not hyphens.** Use an em dash (Option-Shift-hyphen) instead of a hyphen to separate parts of a sentence. Also, when you want to use a symbol in place of the word *to* (such as in a range of time, 5 P.M.–6 P.M., or dates, 1963–1997), use an en dash (Option-hyphen), not a hyphen. But don't use a dash in phone numbers—that's the correct occasion for a hyphen.

**Omit extra spaces.** Don't put two spaces after a period, even though that's not how your high school typing teacher trained you. In typeset text, word spaces tend to be too large, not too small, and reading is slowed by large spaces between words. If you can't break the two-space habit, use your program's find-and-replace function to replace each double space with a single space before typesetting.

### 3. Uneven Leading

Use specific numeric values, not “auto” leading, to preserve line spacing when you insert a large character in a line of text. In fact, it's best to use specific leading values rather than autoleading in all your text.

### 4. Confusing Subheads

Leave more space before a subhead than after it. A subhead logically goes with the text that follows, not the text before.

### 5. Unreadable Display Font

Don't set a display font—a font that's designed and spaced for setting at large sizes—in body-text sizes, because it can make the type illegible. You can get away with using text fonts for headlines, though. You can usually identify display fonts as those that come in a limited range of styles or weights (and there may be no matching italic), such as Lithos and ITC Machine Bold.

### 6. Ligature Surprises

Don't let *ligatures* (two characters fused together, for example the *fi* character you get when you type Option-Shift-5) creep into words set in all caps. This sounds

obvious, since ligatures are lowercase characters, but it happens when you use automatic ligature substitution in lines that are then printed in all caps (by using  $\text{⌘-K}$  or  $\text{⌘-H}$  on selected text or as part of a style, for example).

Don't use ligatures in headlines or

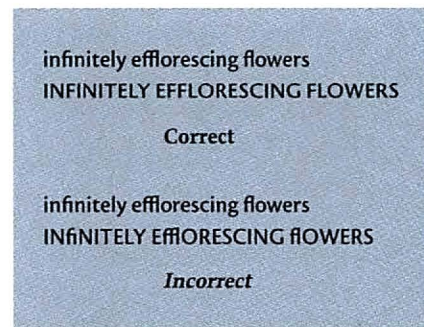

**figure 2 · You'll get nothing but trouble if you include ligatures in strings of all-caps text. If you plan to make text all caps, leave ligatures out.**

other type set in large sizes either. You can't change the spacing within a ligature, yet headlines and large type need to be tracked to tighten spacing. Tracking text with ligatures will only make the ligatures stand out awkwardly. (See figure 2 for a sample blunder with ligatures.)

### 7. Lonely Drop Caps

Although you see it sometimes in even the best publications, a drop cap sitting in a square hole with no visible relationship to the surrounding text is not only ugly but also distracting for readers (see figure 3). It's acceptable to pull the first line close to the cap, although this can look odd (it often helps to use bolder type or small caps for the first couple of words after the cap in this case). You can also fit the regular text around the cap, use an ornamental cap that fills the rectangular space, or use some other technique for drawing the eye to the start of text—a stickup cap, larger lead-in type, or a few words in bold.

### 8. Bad English

Even if the writer got it wrong in the copy, the person setting the type has long been responsible for correcting obvious spelling, grammar, and usage errors. Keep handy a basic guide to usage, such as *The Chicago Manual of Style*; *The Little, Brown Handbook*; or *The Associated Press Stylebook and Libel Manual*. Don't rely exclusively on a spell checker; be sure to proofread carefully to catch ambiguous words.



# Think Hard.

# Play Hard.

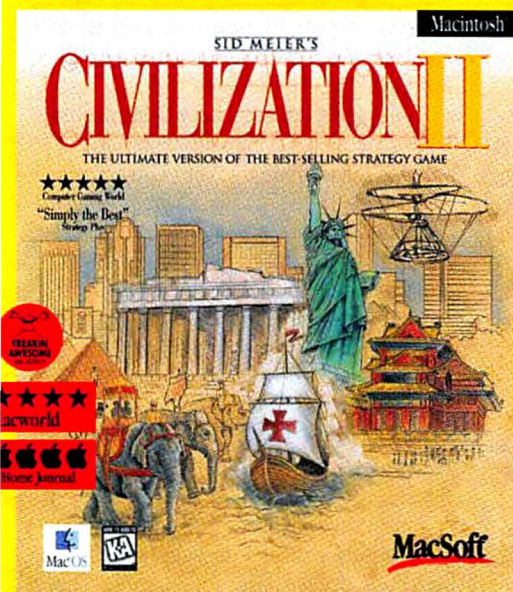

From the creators of Doom comes the most intense, technologically advanced 3D experience ever captured on CD-ROM.

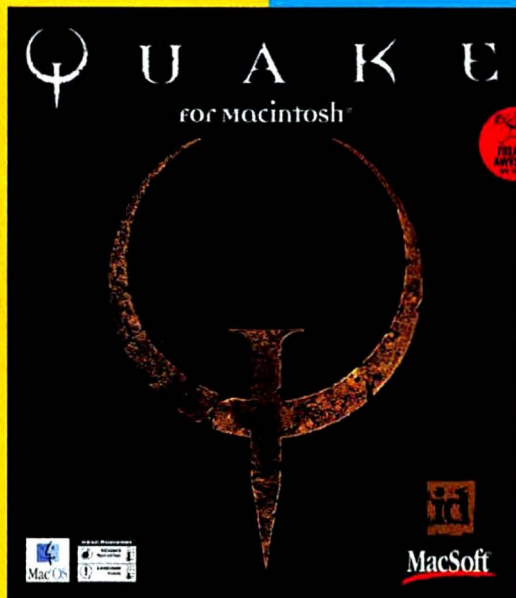

Build an empire to stand the test of time in this strategy game that was called "perhaps the best game on the planet" by Strategy Plus magazine.



This highly-rated, #1-selling 3D shooter offers groundbreaking realism, endless explosive action and a humorous attitude.



Forge an empire to span a universe in this turn-based strategy game. Explore, colonize, conquer, trade and discover new technologies to achieve galactic supremacy.

## 800-229-2714

Call for a free catalog or visit our website at [www.wizworks.com](http://www.wizworks.com)

## MacSoft®

An Affiliate of GT Interactive Software  
2500 Berkshire Lane, Plymouth, MN 55441 612.509.7600

Circle 30 on reader service card

Quake® ©1996, 1997 Id Software, Inc. All Rights Reserved. Duke Nukem™3D ©1996, 1997 3D Realms Entertainment. Master of Orion™ II: Battle at Antares™ ©1996, 1997 Microprose Software, Inc. All Rights Reserved. Civilization® II ©1996, 1997 Microprose Software, Inc. All Rights Reserved.



If you're a CompuServe member, you can get in on the sometimes opinionated conversation about type. In CompuServe, type GO DTPFOR.

**LOOK ON HER**, mark her well; be but about to say she is a goodly lady, and the justice of your hearts will thereto add, 'tis pity she's not honest—honorable. Praise her but for this her without-door form—which on my faith deserves high speech—and straight the shrug, the hum, or ha—these petty brands that calumny doth use . . .

Correct

**A**LONSO OF ARAGON was wont to say in commendation of age that age appears to be best in four things—old wood best to burn, old wine to drink, old friends to trust, and old authors to read, according to Francis Bacon in *Apothegms*, in which he also wrote that “Riches are a good handmaid, but the worst mistress.”

Correct

**A**lonso of Aragon was wont to say in commendation of age that age appears to be best in four things—old wood best to burn, old wine to drink, old friends to trust, and old authors to read, according to Francis Bacon in *Apothegms*, in which he also wrote that “Riches are a good handmaid, but the worst mistress.”

Incorrect

figure 3 • Nothing is sadder than a lonely-looking drop cap (bottom). Here are a couple of ways to integrate drop caps into text.

**Use the right form of *its*.** We all sometimes do it without thinking—add an apostrophe to the possessive form of *it*—yet this error stands out as a badge of ignorance. Be sure to take apostrophes out of the possessive *its* but not out of the contraction of *it is*.

**Put commas and periods within quotes.** Place commas and periods within closing quotes regardless of context. This practice strikes many people as illogical—in fact, it isn't followed in England—but in printed American English, it is correct.

Place all other marks of punctuation—question and exclamation marks, colons, and semicolons—outside unless they're actually part of the quoted material.

**Don't hyphenate contractions.** No sensible person would think of breaking such words as *isn't*, *haven't*, *couldn't*, and *didn't* before the *n*, but a computer sometimes does. The unalterable default hyphenation routines in QuarkXPress (although not in PageMaker and FrameMaker) break contractions, so we see this wretched error whenever QuarkXPress is used for setting text.

Unfortunately, repairing it is a bit tedious. Search for all occurrences of *n't*, and reunite any broken contractions by typing &#-hyphen (the optional-hyphen code) in front of the first letter of each word.

## 9. Crowded Caps

Use tracking to add space to strings of text

you set in all caps to make them more legible and aesthetically pleasing. It's especially important to add space to all-caps sans serif typefaces, because letters tend to run together. Small caps also need extra letterspacing, for the same reason.

Style sheets make it easy to control the letterspacing of all-caps subheads: In PageMaker, include the Very Loose track in the style sheet; in QuarkXPress, assign a specific manual-tracking value. Alternatively, in either program, change the desired/optimum and maximum word-spacing values for the all-caps paragraphs to some high value—50 to 70 percent, for example.

## 10. Inconsistent Style

Handle each category (plain text, A head, B head, subhead, caption, pull quote, and so on) in the same way throughout an article or publication—the same typeface, size, style, and spacing, for example. The best way to accomplish this is by using style sheets and religiously applying a style to every paragraph. (If your software doesn't have character styles—PageMaker does not at this writing; QuarkXPress 4.0 will—you may need to make notes on how you set special kinds of text within paragraphs.)

Graphic designer Kathleen Tinkel writes about typography, design, and prepress. Her *Print Clearly* column appears monthly in *MacWeek*.

## The Key to Better Spacing software adjustments

Rotten spacing can be improved, if not cured, by changing the default settings in your page-layout software. QuarkXPress' default settings tend to enlarge the spaces between words and tighten the spaces between letters. PageMaker encourages looser word- and letterspacing. For hyphenation, the default settings cause other problems. QuarkXPress offers good specific controls, but it is still likely to make hyphenation errors. PageMaker gives you less control over which words to hyphenate, and it sometimes fails to break capitalized words.

You'll get better results from both programs if you use the hyphenation and justification settings shown here. We set the hyphenation zone to 0 and didn't limit the number of consecutive hyphens, because you usually get better spacing if you give the software leeway to hyphenate liberally and then fix the text manually later. In QuarkXPress, we changed a couple of other settings to give the program more freedom to hyphenate: The smallest word that can be hyphenated has five characters, and the minimum number of letters before a hyphen is three.

This doesn't mean that you must necessarily accept all three-letter word stubs or tolerate long runs of hyphenated lines. But it's better to tolerate more than three consecutive hyphens than to allow bad spacing.

It's OK to leave only two characters at the end of a line in a pinch, but not when they're two narrow letters—the eye can fly right past such pairs as *il-* and *li-* at the end of a line, for example. Bringing only two characters down to the next line is less acceptable, but you can get away with it more easily if the letters are wide (*w*, *m*, and *o* are better than *i*, *l*, and *t*) or if they're followed immediately by large punctuation (a question mark, for example) or a closing parenthesis.



QuarkXPress

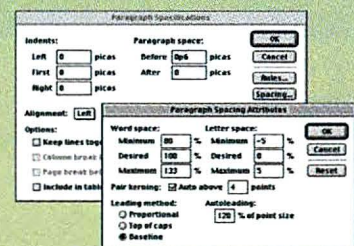

PageMaker

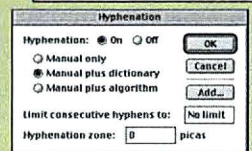



# REAL POOL™

There's nothing virtual about it.



Photo-Realistic 3D in Real Time



Includes these Real Pool games:  
Straight • 8-Ball • 9-Ball • Rotation • Snooker • Spanish • Many more!

Play against the computer or challenge and chat with your friends over the internet.

Created by

Available at Retailers Everywhere!

800-229-2714

Call for a free catalog or visit our website at [www.wizworks.com](http://www.wizworks.com)

System Requirements: Macintosh with a 68040 or higher microprocessor, 8MB RAM, color monitor and CD-ROM drive. Also accelerated for Power Macintosh.



DIGITAL FUSION INC.

## MacSoft®

An affiliate of GT Interactive Software Corporation  
2300 Berkshire Lane No., Plymouth, MN 55441 • 612-509-7600  
Call for a free catalog or visit our website at [www.wizworks.com](http://www.wizworks.com)

©1997 Digital Fusion, Inc.

Circle 25 on reader service card



By Sherry London

graphicsuser@macuser.com

## Mixing Color and Gray Scale

Paint visual impact into a gray-scale image by adding color

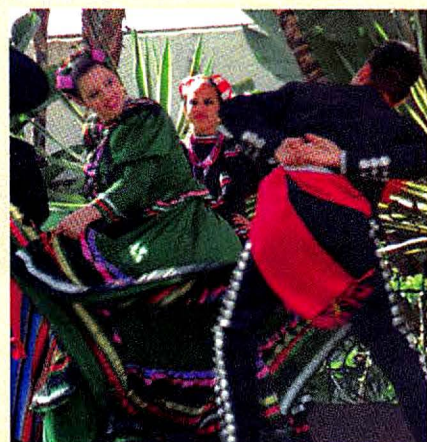

- 1 Select an image that has both an area of interest in the foreground and some interesting details in the background.**

There is little point in mixing color with gray scale in an image that has no detail in the background or whose background is already white (unless you want to simply dab color here and there in the image). Prepare the image by cropping it if needed and sharpening and color-correcting it as required. You'll achieve the best results if you begin with as perfect an image as possible.



- 2 Create a gray-scale duplicate of the image.**

Create a copy of the prepared image (Image: Duplicate). Change the image to Lab Color mode (Image: Mode: Lab Color). In the Channels palette, click on the Lightness channel. Change it to Grayscale (Image: Mode: Grayscale), and click on OK when the dialog box asks to discard other channels. Even if the image looks a bit flat on your monitor, selecting the Lightness channel tends to create a better gray-scale image when printed. If the image is not going to be printed (say you plan to use it only on the Web), you can adjust the values in the image by using the Curves command (Image: Adjust: Curves) to darken the shadows and lighten the highlights a bit more.

**AS I BROWSE THE RACKS** at my local card shop, there's one line of cards that always catches my eye. It features gray-scale images with a hint of color. Selectively adding color is a marvelous way to create a striking image, but it has other benefits too. Because the color immediately attracts the viewer's attention to certain areas of the picture, you have the opportunity to use images that are less than ideal. Let's say you're laying out a profile of your company's top manager, you have just one photo, and it has too much extraneous detail. By coloring, say, just the face in the photo, you can force the distracting detail to recede into the background.

The approach we'll take to create a colorized gray-scale effect is simple. Using Adobe Photoshop, select an appropriate image,

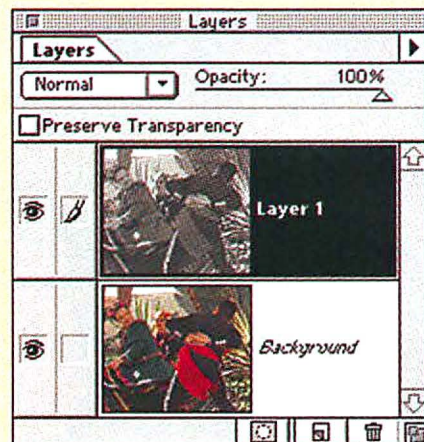

- 3 Combine the color and gray-scale versions of the image in one document.**

Drag the gray-scale image on top of the color original while pressing Shift-⌘. The ⌘ key gives you access to the Move tool, and the Shift key used in conjunction with the Move tool makes the gray-scale image snap onto the color image in perfect register, since the two images are the same size. In addition, using drag-and-drop saves RAM because Photoshop does not need to use the clipboard buffer for storage. You now have an image that contains two layers. You may discard the stand-alone gray-scale image.



prepare it, change a copy of it to gray scale, layer the image, and then create a layer mask in which you paint the areas that you want to remain in color. When you have finished the layer mask, you can soften the color or blur the background.

By using a layer mask, you gain a great deal of control over the final output. Your new image can display the original color along with the gray scale, or you can choose to pop the color to make it more intense or back off on the color to create a hand-tinted, pastel look. You can opt to let just a hint of color show through the gray-scale areas of the image, or you may decide to make a sepia tone from the gray-scale version and combine that with your color image. Softening the focus of the noncolor areas adds a depth-of-field blurring that further highlights the

important parts of your final composition.

Although the basic example shown here contains just a Background and Layer 1, there is no reason to limit yourself to two layers (as you will see in step 6). If you want some of the color in the image to be strong and some to be more subtle, create one layer for the intense colors and another for the more muted colors. Create a layer mask for each intensity, and change each layer's opacity to produce the desired effect. There are many more possibilities for this technique that should be fun to discover on your own.

*Sherry London is a graphic artist and a contributing editor for Computer Artist magazine. She is the author of Photoshop Textures Magic (Hayden, 1997).*



shows layer mask is active

layer mask icon



#### 4 Create a layer mask.

Change your foreground and background colors to the default (black and white, respectively) by clicking on the small black and white squares inside the colors area on the Toolbox. Create a new Layer mask by clicking on the layer-mask icon. Select the part of the image you want to colorize by painting. You don't actually touch the original image; Photoshop records all of your brush strokes on the layer mask. The original data remains available and uncorrupted.

#### 5 Paint on the layer mask to reveal original color areas.

Select the paintbrush, and pick a brush from the Brushes palette (or create one that is the right size and softness for your image). With black as the foreground color, paint over the area you want to show in color. If you make a mistake, press X to paint with white and erase the area you did not mean to paint. Press X again to continue painting with black. (Black hides the image in the current layer; white allows it to be seen.)

#### 6 Modify the look through opacity settings and blending modes.

You can leave the image as it is or control the way the color appears. While you have almost endless possibilities, let's look at several modifications you can make.

Double-click on the Background layer to change it to Layer 0. Doing so allows you to adjust the opacity. Set the opacity to about 80 percent so that the color in the image is a bit lighter. Create a new Background layer by pressing Option as you click on the new-layer icon (just to the left of the Trash Can) at the bottom of the Layers palette. Choose Background as the layer mode in the dialog box that appears. Duplicate Layer 1 by dragging it to the new-layer icon. Click on the image thumbnail in the Layers palette to make the image (rather than the mask) active. A paintbrush icon shows in column two. For the duplicate layer, click on the link icon (it looks like a bit of chain). This unlinks the layer and its layer mask; now apply a Gaussian Blur (Filter: Blur: Gaussian Blur) of about 10.0 (less if your image is small). Because of the layer mask, only the background of the image looks blurred. Drag the duplicate layer so that it's now beneath Layer 1 in the Layers palette, and change the opacity to about 85 percent. This lets some of the original color show through (or will in a moment). Make Layer 1 active, and change its opacity to 15 percent. Change the Blending mode to Multiply. By fiddling with the opacities of the two gray-scale layers, you can change the amount of color that shows through and the sharpness of the background image.





# The industry's solution showcase



You depend on the Macintosh to get work done faster, to stay connected with colleagues and friends, and turn your best ideas into action. Which is why you can't afford to miss the largest event that brings you the world of the Mac.

## Hundreds of New Products and Industry Insights!

Only at MACWORLD Expo can you see and try thousands of products first-hand... learn from Macintosh experts through conferences and keynotes... talk with other Macintosh users and vendors... and stay on top of new developments that could impact your buying decisions. You'll gain valuable insights into how innovative companies are unleashing the power of the Macintosh OS.

## Come evaluate cost-saving solutions for:

- Publishing, entertainment and multimedia
- Web site design and Internet navigation
- Networking, intranets and enterprise-wide connectivity
- Education and R&D
- Business and telecommuting

## Make plans to attend MACWORLD Expo today!

If the Macintosh is part of your business, MACWORLD Expo is your lifeline. MACWORLD Expo is the industry's premier Macintosh event, and dramatic software introductions scheduled for 1998 may make this year's event the most exciting ever. Gain new insights into the future world of Macintosh... see the hottest and coolest new products... and get the inside view of the Macintosh OS platform. Register to attend today.

Owned & Produced by:

 **IDG**  
WORLD EXPO

Managed by IDG Expo Management Company

Sponsored by:

**Macworld**  
**MacWEEK**

# Macworld EXPO

san francisco  
new york



## Macworld/Pro Conference

**The Macintosh Professionals  
Conference only at: MACWORLD  
Expo/San Francisco and New York.**

Please send more information on MACWORLD Expo

- San Francisco     New York  
 Attending         Exhibiting

**MCW**

Name \_\_\_\_\_

Title \_\_\_\_\_

Company \_\_\_\_\_

Address \_\_\_\_\_

City/State/Zip \_\_\_\_\_

Phone \_\_\_\_\_ Fax \_\_\_\_\_

email \_\_\_\_\_

Mail to: MACWORLD Expo, 1400 Providence Highway,  
P.O. Box 9127, Norwood, MA 02062. Or Fax to: 781-440-0363  
**THIS IS NOT A REGISTRATION FORM.**

**For Details:**

**www.macworldexpo.com**  
**or 800.645.EXPO**



By Jason Snell

[jason@macuser.com](mailto:jason@macuser.com)

# Walking the Browser Tightrope

You can't please everyone—but if you want a Web audience, you should at least try

**CHOOSING WHAT'S HOT** and what's not on the Web—whether it's an HTML tag, a plug-in, or even a Web browser—is a tough decision. It's one that Webmasters and Web authors working in the trenches have to make every day. If they make the wrong decision, they risk turning away half their audience.

## The Web Before Gates

The day the first Netscape beta appeared, back in 1994, the Web game changed forever. Before Netscape, there were so few HTML tags and browsers that Web authors didn't have many choices to make—they just used the available tags. But Netscape rose to prominence by giving those chafing Web authors new tags that allowed them to create more-attractive pages. And since those pages looked so much better in Netscape than in Mosaic, most people started to use Netscape. An Internet upstart was born.

As Web authors started using more and more tags, pages designed for use in Netscape started to look worse and worse—or break altogether—in Mosaic, Lynx, and other browsers. Web designers had to start walking the tightrope they continue to walk today, trying to make

their pages look as cool as possible in the latest browsers while still making them readable by the widest possible audience.

Then Bill Gates, who has more money than Oprah, decided to try to crush Netscape, forcing Web designers to choose between creating pages that will look good in Netscape Navigator and those that will shine in Microsoft Internet Explorer. Microsoft and Netscape keep trying to one-up each other by adding a snazzy new feature that also happens to be totally incompatible with the competition's similar snazzy new feature.



## Refuse to Be a Victim

Although it takes some restraint and a lot of patience, you can create a page that looks pretty good in both Navigator and Internet Explorer—and you should. For the foreseeable future, people are going to come to your Web site with both browsers. That's important to keep in mind, because once you're lucky enough to find a Web audience, the last thing you want to do is turn away a big portion of it because it's not using your favorite browser.

If you hand-code a lot of your Web site by using a tool such as Bare Bones Software's BBEEdit, being compatible means taking the extra time to check every page you create in both browsers. Preferably try out your pages with the last few versions of each browser.

If you use visual Web authoring software, such as Adobe PageMill or GoLive CyberStudio, you should be sure to check your documents with both browsers and complain to the tool's maker if it gener-

ates code that one or the other browser renders badly.

## The Struggle to Fit In

Exciting new features of the Web will usually cause you the most trouble. For example, toying with Dynamic HTML, using a plug-in, running a Java applet, or embedding a JavaScript in a Web page are all acts that can lead to compatibility problems. With a plug-in, you can have compatibility problems no matter what browser your Web-site visitors use, since they may not have the plug-in installed, may be using a different version of the plug-in from the one you do, or may even be using a different plug-in that also handles the type of data you put on your page.

Simple elements, such as HTML tables, can also be interpreted in wildly different ways, even by different versions of the same browser. For example, I've discovered that a table that looks fine in Internet Explorer and past versions of Netscape Navigator doesn't look right in Netscape Communicator 4.0 (it has overlapping columns, which should be impossible for an HTML table).

If you think this sort of inconsistency makes it hard on Web authors and the developers of Web authoring tools, you're right. Not only must Web authors keep a catalog of HTML inconsistencies in order to avoid designing an Internet Explorer-only or Netscape-only page but they've also got to become experts at finding workarounds for mistakes that aren't their fault. Authoring tools such as NetObjects Fusion have had to have ridiculous workarounds, such as littering every page with dozens of invisible GIF images, in order to get pages to be truly WYSIWYG in most browsers.

## Duty Bound

All of us have to be vigilant and make sure our little corner of the Web stays compatible with as many browsers as possible. But at the same time, Microsoft and Netscape need to step back from their feature war for a minute and focus on making their browsers compatible with one another in as many ways as possible. After all, even the coolest feature isn't much use if half the people on the Web can never see it. ☹

.....  
*Mr. Blackwell (www.mrblackwell.com) says Macworld Senior Associate Editor Jason Snell looks best when viewed in Internet Explorer 4.0.*



**YOU DON'T HAVE TO** give up your Mac, your investment in Mac software, or your Mac experience just because your boss or your most important clients insist that you accommodate their devotion to the Windows operating system. There are several ways to perform your duties in Windows without giving up your most productive tool. If you're lucky, all you'll have to do is use cross-platform applications or file-translation software. If you're not so lucky, you'll have to use Windows-only software, such as Microsoft Access or Computer Associates' ACCPAC. In that case, your best option is to emulate Windows on your Mac.

Since installing Windows on a Mac is not a matter to be treated lightly, let us help you decide whether it's best to use software or hardware to emulate Win-

dows on your Mac. We also offer some tips on using Windows emulation (both hardware and software) that could save you a lot of hassle.

## See Windows through Software

At about \$200 or less, software emulation is the least-expensive way to go, but for some people it's not worth the savings. It can be irritatingly slow—there's a noticeable typing lag, and commands require at least a second to take effect. So we recommend it to those who only occasionally have to run a Windows application. It's not ideal for everyday use.

At press time, there were two programs to choose from: SoftWindows, from Insignia Solutions, and Virtual PC, from Connectix (go to the Macworld online site at [www.macworld.com](http://www.macworld.com) to see reviews of both these products in the *Macworld* and *MacUser* archives). Both programs recreate the Windows environment within your Macintosh. You can run any Windows software, as long as you have the RAM, a PowerPC-based Mac, and enough disk space.

## SoftWindows

If software emulation seems like a good fit for you, go ahead—buy it, and install it. But before you go too far, here are a few tricks to help you avoid some problems we ran into with SoftWindows.

- **Optimize Your Hard Disk.** Do this before installing any software or hardware emulation product. They require a big chunk of space on your hard disk (at least 250MB).

- **Install the Software Correctly.** Don't try what we first did: We installed SoftWindows 3.1 and then upgraded it with the real Windows 95. While this can be done, it takes an awfully long time and the result is a very slow operating system—about one third as fast as what you get if you do it the right way. The right way to do it is to install SoftWindows 95 directly.

- **Give It Lots of Memory.** A good amount of RAM to dedicate to SoftWindows is 24MB. It's best to use real RAM, since SoftWindows doesn't work with RAM Doubler and sometimes won't even work with Apple's Virtual Memory.

- **Speed Up Launches.** Use SoftWindows' TurboStart option to reduce launch time. It saves your current settings when you quit so that the next launch takes less than a minute. To make

By Scott Bury

[smartuser@macuser.com](mailto:smartuser@macuser.com)

# Have Mac, Will Do Windows

Rather than part with your Mac,  
teach it to do Windows

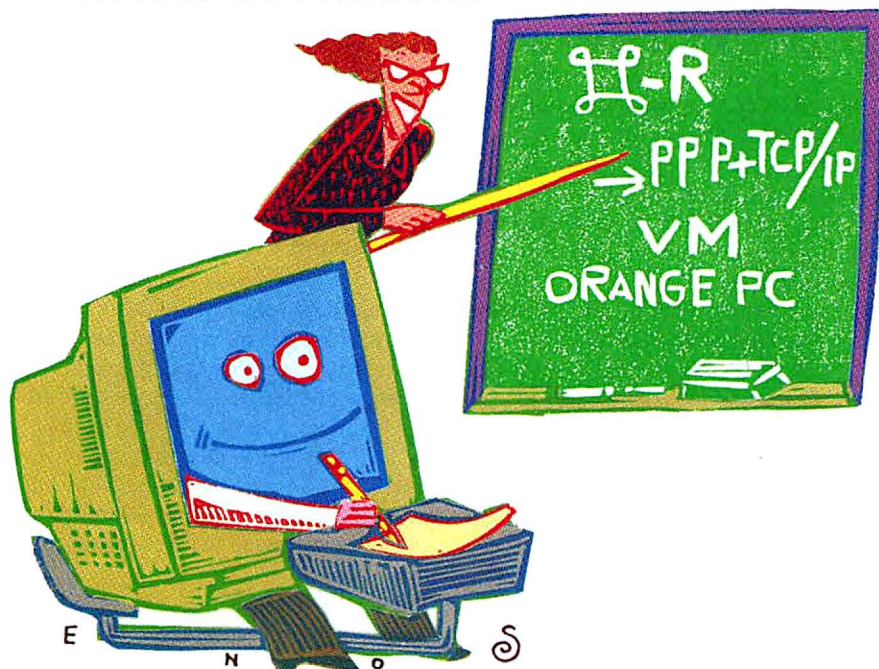



TurboStart work, select Shut Down from the Start button menu in Windows—don't select Quit from the File menu in the Mac environment.

• **Make More Room for Windows.**

SoftWindows comes with Hard Disk Expander (see figure 1), software that makes it easy to increase the amount of hard-disk space you allocate to SoftWindows. To use it, you must quit SoftWindows and then double-click on Hard Disk Expander.

• **Thaw a Frozen Pointer.** If you can't move the Windows pointer with your mouse, then use the Mac's pointer to select the Setup menu and Emulate PC Mouse. Use ⌘-R for the right mouse button.

• **Avoid Floppy Jams.** Make sure you don't have a floppy disk in the drive when you launch SoftWindows, or you'll have to eject it with a paper clip. CDs don't seem to have the same problem.

• **Connect to the Internet the Easy Way.**

If you want to use SoftWindows to connect to the Internet, keep in mind that peripheral devices, such as your modem, connect through the Mac OS. You can opt to set up the modem and Internet connection through the Windows control panel under the Settings menu. However, it's much easier to use the SoftWindows Setup menu to route your Windows browser and e-mail connection through the Mac's PPP and TCP/IP utilities. This method is slow, but it's seamless and reliable.

## Virtual PC

Using Virtual PC is similar to using SoftWindows, but there are enough differences that we've included some tips to help you take advantage of this software specifically.

• **Run More Software.** Virtual PC doesn't seem to have the problem with Virtual Memory (VM) that SoftWindows does.

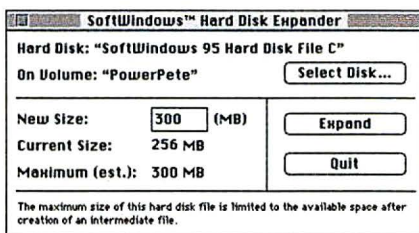

figure 1 • You're bound to need more disk space for Windows applications and files at some point. Of all the emulation software and hardware, SoftWindows gives you one of the easiest ways to allocate more space, using Hard Disk Expander.

That means you can use VM to increase your memory enough to run RAM-hungry Mac programs and RAM-hungry Windows programs at the same time. Be warned, however, that using VM may slow you down.

• **Speed Up Windows.** Don't try to run two memory-hungry Windows programs at the same time through Virtual PC. Even if you have lots of real RAM, running them simultaneously is likely to make processing painfully slow.

• **Get Modem Help.** Unlike SoftWindows, Virtual PC controls your modem directly rather than filter commands through your Mac. This means you have to set up the modem through a Windows control panel. Unfortunately, you won't get much help from the manual. Rather than get frustrated trying to figure out Windows modem settings, call your Internet Service Provider's technical support for help.

## Throw Hardware at It

Software emulation is functional but slow. If you need to work frequently in Windows, you're better off spending the extra money for a Windows-emulation card (which goes into an expansion slot in your Mac). At press time, there were three PCI expansion cards that put a Windows computer into your Macintosh: Apple's PC Compatibility Card (\$1,049), Orange Micro's OrangePC Coprocessor (starting at around \$700, depending on what's installed on the card), and Radius's Détente card (Radius has a range of cards that start at \$700).

The main advantage to using hardware emulation is that it gives you a real PC. It's a lot faster, and you'll have fewer problems installing new applications and utilities.

The main disadvantage of the hardware approach is that you can buy a midlevel Pentium PC for about the price of some of the cards. It's up to you to decide whether the convenience of having two machines in one is important or if you'd rather make space for a second computer.

If you decide to install a PC-emulation card, these tips on using the cards could make your life easier.

• **Buy More Windows Real Estate.** Once you allocate hard-disk space to Windows, using the software that comes with the emulator cards, you are unable to increase that space. (Unlike SoftWindows, the

cards don't come with Hard Disk Expander software.) Instead, you can create another file to serve as a D: drive or second hard disk.

• **Switch Quickly.** The handy keyboard shortcut for switching between Windows and Mac environments is ⌘-Return. You can use it if you have the Apple or Radius cards. However, with the Orange Micro card, you must launch the OrangePC application in the Mac environment and then use ⌘-D to get to Windows.

• **Find Missing Files.** It's easy to share files between the Mac OS and Windows, but it's possible that some files might seem to disappear. If you're not able to open a shared file from within an application, try dragging the file from Drive F: (the drive that receives shared files) to Drive D:. That may make it magically appear.

• **End a Freeze.** If you get stalled for more than a couple of minutes while you're shutting down Windows, you can hit ⌘-Return to get to the Mac environment and then choose Shut Down PC from the PC Setup control panel. It won't shut down Windows properly, but it may be your only option.

• **Identify Problem Programs.** If you're using the Apple card and have a Windows application that simply refuses to launch, it could be that the application won't work with this particular card. For instance, we couldn't get Microsoft Internet Explorer to work. If you have the same problem, check the application's manual to see if it requires 32-bit memory addressing. If so, the Apple card can't support it because the card has only a 16-bit bus. (Apple promises an upgrade soon.)

• **Speed Up Printing.** If you have the Orange Micro card, you can speed up printing: Use its LPT1 connector to connect directly to a printer, and select LPT1 from the Windows Printers folder.

## A Tip about Tips

Our tips are mainly aimed at helping you use whichever emulation product you choose, but we hope they'll also help you decide what to buy. They may make it clearer what specific snags you'll run into when using either type of emulation product. ☞

Scott Bury is a writer and editor based near Toronto, Canada, who finds it much easier to install Windows on a Mac than to hang wallpaper in his house.





By Bob LeVitus and Christopher Breen

## Help Folder

Mac OS 8's new Contextual Menus and View Options, and your very own slide show

### Those Cool Contextual Menus

Mac OS 8's Contextual Menus are by far its best new feature. But I want more. Is there a way to customize them? I'm not afraid of ResEdit if it's necessary.

Richard Gnoiss, via the Internet

**Bob:** ResEdit won't be necessary, because there are already a bunch of cool Contextual Menu utilities available. For example, I'm using freeware called FinderPop, a slick Mac OS 8-only control panel by Turlough O'Connor that adds various submenus to the Finder's Contextual Menus. These include a Processes submenu; a Contents submenu (allowing you to see the contents of a folder you've selected in the Finder); and of course, the FinderPop submenu. FinderPop displays everything inside a special FinderPop Items folder—much like the Apple menu displays everything inside the Apple Menu Items folder—when you click on a volume (see figure 1).

**Chris:** Or try Mark Aiken's \$15 shareware control panel PowerMenu. It costs more but does a whole lot more than FinderPop. And as an added bonus—pay attention here if you have an older Mac or haven't yet upgraded to Mac OS 8—PowerMenu

brings all the fun of Contextual Menus to System 7 users.

**Bob:** And if you're as crazy about Contextual Menus as we are, you'll love the CM Central Web site ([www.interdesign.ca/cmcentral/](http://www.interdesign.ca/cmcentral/)), the premier location for Mac OS 8 Contextual Menu plug-ins.

### No Room for Views

I find it very frustrating that unlike System 7.5.x's, OS 8's View Options doesn't let you globally change your list options—show or hide Relative Date, Date Modified, Size, and Kind, for example. Do you know of any way to do this?

Jeffrey Campo, via the Internet

**Chris:** As much as I adore OS 8, I've got to say that Apple really dropped the ball on this one. Sure, it's lovely that you can adjust views for windows individually, but being able to do so globally is just as important—maybe more so.

**Bob:** Why Apple removed this feature, I'll never know. Unfortunately there's no easy way to set views globally—and no, using the old Views control panel from 7.5.x or 7.6.x won't work. But if any enterprising shareware author would like to come up with a solution, we'd love to see it.

I have a couple of AppleScript droplets I picked up off the Web that can help set views globally, but they're a little kludgy and both require Jon Pugh's collection of scripting additions, Jon's Commands ([www.infoworkshop.com/~jonpugh](http://www.infoworkshop.com/~jonpugh)). (For the uninitiated, a droplet is a special type of AppleScript application, or applet, that acts like a drop box onto which you can drag files to have some kind of operation performed on them.)

The first is John Blackburn's SetViewOptions, an AppleScript droplet that changes the view options for each folder contained within the folder you drag and drop onto the droplet. Changing view settings requires that you open the droplet in AppleScript's Script Editor and edit the droplet's script. Instructions for editing the script are included in the SetViewOptions documentation.

The second droplet is Garth Martin's OS 8 Views Setter v2.0. Unlike SetViewOptions, this droplet pops up a series of yes-or-no dialog boxes—"Use relative date?" for instance—to set views.

Problem is, both scripts are slow.

**Chris:** I've got to agree. Although the scripts work, they're hardly swift. While looking for an alternative, I took the

macro route, via WestCode Software's OneClick. Lo and behold, I came up with something a little faster that can change the list view of many folders at one time—but the macro is still kludgy, in that it can't dig down through a parent folder and change all the folders within.

Using OneClick, I attached this script to a new button and placed it in my OneClick Finder palette:

```
On DragAndDrop
  Type Command "O"
  While (Window.Front <> "Desktop")
    SelectMenu "View", "as List"
    SelectMenu "View", "View Options,.."
    SelectButton Check "Date Modified"
    SelectButton Check "Date Created"
    SelectButton Check "Size"
    SelectButton Check "Kind"
    SelectButton Uncheck "Label"
    SelectButton Uncheck "Comments"
    SelectButton Uncheck "Version"
    SelectButton "OK"
  CloseWindow
End While
End DragAndDrop
```

**Bob:** Mighty impressive. What's it do?

**Chris:** When you drag and drop a folder or a group of folders onto the button, it first opens all of the folders. It then marches through each folder in succession and assigns List view to the contents; selects Date Modified, Date Created, Size, and Kind in the View Options dialog box; and closes each folder as it finishes.

To change View Options, open the script in the OneClick Editor and change the status of the Check and Uncheck commands—for example, to view Comments, change "Uncheck" to "Check" in the script outlined above.

**Bob:** Swift. But I still hope we see an easier shareware solution soon.

### Slipping Slide Show

Do you know of any slide-show software that allows images to be shown at differing intervals? For example, the second picture would appear a minute after the first but maybe the third would pop up 30 seconds after the second.

Robert Reinhard, via the Internet

**Chris:** Of course, we know of such software. The only remaining question is: Are you willing to pay big bucks for it, or would you prefer to take the more complicated, penny-pinching route?



## Reader Tip • Refining America Online

### Pitching AOL's Pitches

The sales pitches that automatically appear when you log onto America Online can be annoying. Thankfully, AOL has now provided a way to turn them off. Here's how:

Type Keyword: Marketing Prefs, and double-click on Tell Us What Your Pop-up Preferences Are. In the bottom right corner, click on the box next to the item that mentions "special member benefit pop-up offers." Check the box stating, "I prefer not to receive special member pop-up offers from AOL." Other Marketing Prefs include Tell Us What Your Mailing Preferences Are—use this to request that AOL not provide your name to mass-mailing marketers—and Tell Us What Your AOL E-Mail Preferences Are, an option for requesting that AOL not provide your name to mass e-mail marketers.

Justin Leavens, via the Internet

**Bob:** Because I know Chris always goes the cheaper way, I guess it's up to me to supply the expensive answer. And that answer is powerful presentation and multimedia software.

If you already own a copy of Microsoft Office, you have one solution at your fingertips: PowerPoint. This presentation package does exactly what you want—allows you to set the amount of time each slide is displayed. Adobe's Persuasion—another presentation package—does this as well.

Although using PowerPoint or Persuasion is the easiest way to achieve your goal, you can instead opt for Apple's HyperCard or Allegiant Technologies' SuperCard. To make a slide show with either of these programs, just paste the pictures you want onto separate cards and write a small script for each card that tells it how long to wait before advancing to the next card.

Of course, there are also two really expensive solutions—Macromedia's Director and Quark's QuarkImmedia—but they each cost around \$1,000. Obviously, using Director or QuarkImmedia to create a simple slide show is like buying a Ferrari to drive three blocks to the local Seven-Eleven—flashy, but hardly the best use of your hard-earned money.

**Chris:** An inexpensive shareware slide-show application would be a better

choice, but unfortunately, I couldn't find one that satisfies your varying-time requirement.

**Bob:** Ah, but you're one of the Help Folder guys, so that didn't stop you!

**Chris:** You're darned tootin', it didn't! With the help of a macro utility—I used CE Software's QuicKeys for this one—I was able to create a variable-speed slide show in next to no time at all.

For my host applications, I chose Thorsten Lemke's amazing \$35 GraphicConverter and Aaron Giles' equally stupendous postcardware, JPEGView. Although it's hardly the main purpose of these utilities, they both sport slide-show components that allow you to advance slides by clicking the mouse button or pressing the Return key. Here's the procedure for creating the macro:

Gather together the pictures you want to display in your slide show—putting them in a single folder is the easiest way to go about it. Then locate the slide-show options for each program. In GraphicConverter, you'll find them by selecting Slide Show from the File menu, clicking on the Options button, and then selecting the Time tab. In JPEGView, select Slide Show Options from the File menu.

For QuicKeys to do its job properly, you must turn off any automatic slide-advance functions in these Options dialog boxes. In GraphicConverter, you click on the "After mouse click" button in the Time dialog box, and in JPEGView, you select "User-controlled" from the left-hand pull-down menu.

Now the easy part: Select Record Se-



figure 1 • FinderPop freeware beefs up your Contextual Menus in three ways.

## Reader Tip • System Software

### Get Your Files in Order

If you have an extended keyboard, there's a way to place a file or folder at the end of a list that's organized by name—without visibly changing the filename.

Highlight the file or folder name in the Finder, and press the left-arrow key to move the cursor to the beginning of the filename. Then press the Forward Delete key (under the Help key). You won't observe any change in the name, but when you click outside the name field, that file or folder will drop to the bottom of the list.

Paul Zugnoni, via AOL

quence from the QuicKeys menu, fire up the slide show, and press Return to advance through all your slides. Once you've reached the end, you'll need to exit the slide show. To do so in JPEGView, type ⌘-period and then ⌘-W. To quit GraphicConverter's slide show, simply type ⌘-period. Finally, select Stop Recording from the QuicKeys menu.

All that's left for you to do now is name the QuicKey, assign a keyboard shortcut to it, delete all those Wait commands inserted by QuicKeys, and insert a User/Timed Pause between all the slides. The User/Timed Pause shortcut is where you specify how long each slide will be displayed on your screen.

When you want to run that slide show in the future, just tell the applications which slides to show, start the slide show, and fire up your QuicKey. Voilà! Timed slide show on the cheap!

**Bob:** With this column, our work is done here.

**Chris:** And as sorry as we are to go, we'd like to take this opportunity to thank our ever faithful Help Folder readers.

**Bob:** So, as Chris makes the appropriate sound effects in the background...

**Chris:** ... clip, clop, clip, clop ...

**Bob:** ... we will ride slowly off into the sunset.

**Bob & Chris in unison:** Thanks! Good night! You've been a beautiful audience! 🍷

Bob LeVitus is the author of Mac OS 8 for Dummies and is the Mac columnist for the Houston Chronicle. Christopher Breen recently coauthored The Macintosh Bible Guide to Games, published by Peachpit Press.



# MORE POWER FOR DIRECT



## Elite 1212

- 1200 x 1200 dpi resolution
- 12 pages per minute
- 1 year Platinum Exchange Warranty
- Letter, legal, A4, envelope
- Maximum print area: 8.5" x 14"
- 250 sheet Universal Tray
- PostScript® Level 2 compatible, PCL 5
- 80 PostScript fonts, 15 PCL fonts
- 8MB RAM expandable to 64MB

### Connectivity:

- Ethernet® (10 BaseT, 10 Base2)
- EtherTalk, TCP/IP, NetWare®
- Parallel, LocalTalk®, RS422 Serial

- Extra Universal Tray Add \$129
- Second Paper Feeder Add \$399  
(Includes 500 sheet Universal Tray)
- Envelope Cassette Add \$129
- Extra 8MB memory\*\* Add \$89

# \$1399

Business Lease: \$66/Month

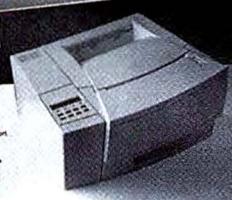
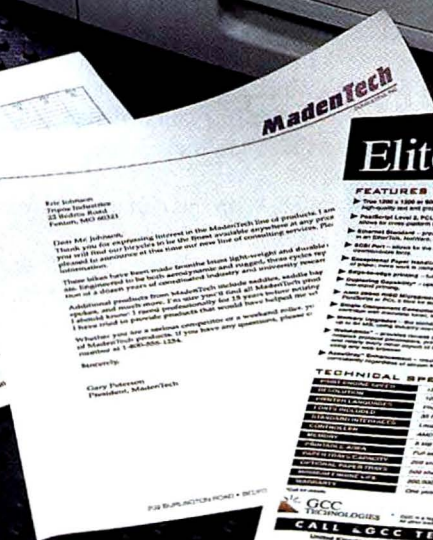

1200 X 1200 DPI RESOLUTION, FULL FEATURED LASER PRINTER WITH 8MB RAM

BACKED BY GCC'S EXCLUSIVE PLATINUM EXCHANGE<sup>SM</sup> PROGRAM



# YOUR PRINTER DOLLAR. FROM GCC.

**F**or over a decade, GCC Technologies® has been a leader in laser printer technology satisfying the extremely demanding output needs of graphic arts professionals. Now GCC takes that expertise and applies it to a new line of business printers.

Introducing the Elite 1212™, the Elite XL 608 LC™, and the Elite XL 616™. Printers that deliver the output quality, reliability, flexibility and value your business demands. GCC printers offer you multiple printing options specific to your business' needs. So whether you require 8.5" x 11" or 11" x 17" output (ledger), GCC has a solution for you.

When you purchase your printer directly from GCC, you receive advanced laser technology at affordable prices. All printers purchased directly are backed by our exclusive Platinum Exchange Program which virtually eliminates downtime.

More power and Platinum Exchange. Only from GCC.

## Elite XL 608 LC

- 600 x 600 dpi resolution
- 8 pages per minute
- 1 year Platinum Exchange Warranty
- Ledger, letter, legal, A4, envelope
- Maximum print area: 11" x 17"
- 250 sheet Universal Tray
- PostScript Level 2 compatible, PCL 5
- 80 PostScript fonts, 15 PCL fonts
- 8MB RAM expandable to 64MB

### Connectivity:

- Ethernet (10 BaseT, 10 Base2)
- EtherTalk, TCP/IP
- Parallel, LocalTalk, RS422 Serial

Extra Universal Tray	Add \$129
Second Paper Feeder*	Add \$319 (Includes 250 sheet Universal Tray)
Second Paper Feeder*	Add \$419 (Includes 500 sheet Letter Tray)
Extra 8MB memory**	Add \$89

# \$1799

Business Lease: \$86/Month

## Elite XL 616

- 600 x 600 dpi resolution
- 16 pages per minute
- 1 year Platinum Exchange Warranty
- Ledger, letter, legal, A4, envelope
- Maximum print area: 11.69" x 20"
- 250 sheet Universal Tray
- PostScript Level 2 compatible, PCL 5
- 80 PostScript fonts, 15 PCL fonts
- 8MB RAM expandable to 64MB

### Connectivity:

- Ethernet (10 BaseT, 10 Base2)
- EtherTalk, TCP/IP, NetWare
- Parallel, LocalTalk, RS422 Serial

Extra Universal Tray	Add \$129
Second Paper Feeder*	Add \$319 (Includes 250 sheet Universal Tray)
Second Paper Feeder*	Add \$419 (Includes 500 sheet Letter Tray)
Extra 8MB memory**	Add \$89

# \$2199

Business Lease: \$106/Month

## Service. Satisfaction. Guaranteed.

### ▶ Platinum Exchange.

Every GCC printer purchased direct is backed by our exclusive Platinum Exchange Program. If anytime during the warranty period a printer problem can't be resolved through GCC Technical Support, we'll send you a replacement printer† overnight. No downtime while waiting for repairs.

### ▶ 30-day money back guarantee.

Every printer and consumable is fully backed by our unconditional, no-questions asked, 30-day money back guarantee.

### ▶ One full-year warranty.

Every GCC printer is protected by a minimum one year parts and labor warranty. And, yearly extensions are available.

### ▶ FREE unlimited technical support.

throughout the warranty period. GCC Technologies is on call for you at 781-276-8620, Monday through Friday, 9 AM to 8 PM (et) or by EMail: support@gcctech.com.

† Shipping and handling will be reimbursed only if product is defective.



To order, Toll Free

**1-800-422-7777**

Mon-Fri 9 AM to 8 PM (Eastern Standard Time)  
Sat 10 AM to 4 PM (Eastern Standard Time)

[www.gcctech.com](http://www.gcctech.com)

Keycode 801MWC

\*The Elite XL 608 LC supports one optional paper feeder. The Elite XL 616 supports two additional paper feeders.  
\*\*Please call for pricing on additional memory configurations.

GCC Technologies is a registered trademark of GCC Technologies, Inc. Elite 1212, Elite XL 608 LC, Elite XL 616, and Platinum Exchange are trademarks of GCC Technologies, Inc. All other trademarks or registered trademarks are trademarks of their respective companies.



**MY PARENTS BELIEVED** that children who stepped outdoors barefoot between the months of October and May would contract pneumonia. They were likewise convinced that if my impressionable young mind were exposed to the wicked antics of the Three Stooges for even a single afternoon, I'd spend the better part of my adult years hewing rocks in the State Pen. Hence my impatience to grow up, leave home, expand my horizons—in other words, try everything my parents would heartily condemn.

I'm all grown up now, but my rebellious streak still survives. And thanks to modern computing, I can feed the rebel in me and dabble in *The Forbidden* without ever leaving the safe confines of home. Feel the need to be naughty? Join my stroll through the mildly mean streets of Macintosh software.

By Christopher Breen

[maxuser@macuser.com](mailto:maxuser@macuser.com)

# The Forbidden Mac

Software Mom may disapprove of

## Sex

Seeking the taboos of my childhood rather than those of my adulthood, I skipped the adult-entertainment products advertised in the back of some computer magazines. Instead, I began my journey down the prohibited path with Cambrix Publishing's comparatively chaste

**Swimwear Illustrated** (★★★, \$23.98 list).

The cover dared me to "get interactive with supermodels," so imagine my heart-break in discovering that the interactivity was limited to the lame exercise of watching one model's face morph into another.

The rest of the CD-ROM is devoted to pictures of young women thrusting out one hip or the other while dressed in skimpy swimwear. If this is your idea of hot stuff, you may find the annual *Sports Illustrated* swimsuit edition or a subscription to *Swimwear Illustrated* magazine a better investment.

## Drugs

Considering the drug education I received at school and home, I expected simplistic "Just Say No" platitudes from Electronic Vision's **Uppers, Downers, All Arounders** (★★★★, \$170 list). But my fears were groundless. This comprehensive CD-ROM addresses substance abuse in an even-handed and informative manner.

It's a text-intensive disc, though, and hardly a multimedia marvel; narration or pictures only occasionally accompany the hyperlinked text. The CD-ROM's real strength lies in its wealth of information—much of it taken from research conducted by San Francisco's highly praised Haight-Ashbury Free Clinic.

*Uppers, Downers, All Arounders* is too expensive and detailed for home use, but every school and community organization wanting to educate people about abusable substances should have a copy.

## Lies

Married during the early years of the Eisenhower administration, my parents were surely influenced by the mores of the day. To understand my elders' odd admonitions, I felt compelled to dig through the remains of that period of American history, via Voyager's ten-volume series, **Our Secret Century** (★★★★, \$29.95 list each two-volume set).

Five boxed sets contain more than 100 short "educational" films produced in the U.S. during the 1950s and early 1960s. Each set has 6 to 15 films that focus on a





**The Forbidden City**

"Eenie, meenie, chile beenie, the spirits are about to speak..." Check out the esoteric arts online at [www.interart.net/forbidden/default.html](http://www.interart.net/forbidden/default.html)

**The Forbidden Directory**

particular topic—personal hygiene, sex education, or juvenile delinquency, for example. Each film is accompanied by discussions accessed through nicely annotated pop-up notes.

Post-baby boomers will find the films' outdated messages quaint and comic, whereas those who lived through the times may be shocked anyone took such lockstep propaganda seriously. Young or old, everyone will gain insight into the bland, homogeneous culture foisted on post-World War II America.

**Feelings**

Emotional self-examination was hardly encouraged around my childhood home, so my sensitive, adult self decided to gauge how I fared against the norm with Virtual Knowledge's **Emotional IQ Test** (♦♦♦, \$24.95 estimated street).

Your ability to identify and understand emotions is tested via multiple-choice questions; for example, you're asked to look at an image of someone's face and state which emotions it conveys.

Although I was judged to be highly empathetic and perceptive, the obvious nature of the questions made me wonder what sort of insensitive louse would fail to score well. Also, I had to wonder who would bother to use the software more than once. If you score badly, do you want to hear once more that you're an imperceptive jerk? Although I don't buy the "science" behind it, the Emotional IQ Test is inexpensive enough for entertainment.

**Pulp Fiction**

Deprived of the Three Stooges, I took youthful refuge in the pulpy pages of 15¢ comic books. But as I outgrew the Justice League of America and developed a taste for *National Lampoon*, my misguided mother threw away my entire comic-book collection. I paid homage to these days of my misunderstood youth via Voyager's **Comic Book Confidential** (♦♦♦♦, \$39.95 list).

The CD-ROM's centerpiece is Ron Mann's QuickTime-formatted documentary film *Comic Book Confidential*, which traces the development of comic books and their writers from the mid-1930s through modern times. The film, although chronologically presented, isn't a strict history; Mann uses interviews with such key artists as Will Eisner and R. Crumb to flesh out the story.

The disc also has artist biographies and work samples, but hard-core fans may be disappointed by the absence of some favorite artists, such as Matt Groening.

Comic Book Confidential is not for everyone—particularly children and folks offended by adult themes. But being neither child nor squeamish adult, I thoroughly enjoyed it.

**The Black Arts**

My folks would have frowned on me jeopardizing my immortal soul by dabbling in the psychic realm. And therein lay my inspiration to try out Multicom's **Mystic Discovery Suite** (♦♦♦, \$39.95 estimated street), a collection of three CD-ROMs.

The Astrology Source CD-ROM created astrological charts based on the date, time, and place of my birth. Its results were in typical horoscope-speak ("As an ambitious Capricorn you exhibit little emotion, but deep down bear a heart of gold"), but at least the reading was consistent. The Cyber Tarot and Palmistry CD-ROMs, however, had a few consistency problems; I mean, how could I be both disorderly and overly tidy?

Mom and Dad are unlikely to lose me to the Covenant of Transcendental Meditators, but the Mystic Discovery Suite's clean interfaces and copious multimedia elements kept me nicely entertained.

**The Seventh Circle**

Until this point, I had only flirted with the forbidden. It was now time for a wrenching and chilling foray into the

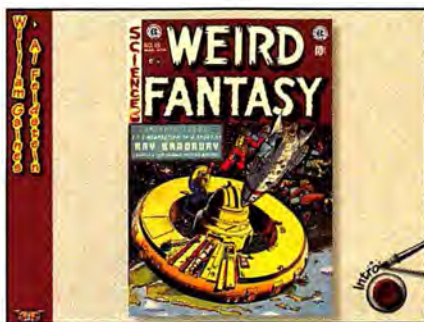

**Cambrix Publishing**  
Chatsworth, CA  
800/992-8781  
818/993-4274  
[www.cambrix.com](http://www.cambrix.com)

**Electronic Vision**  
Athens, OH  
800/691-8480  
614/592-2511  
[www.ev.net/fitne](http://www.ev.net/fitne)

**Multicom Publishing**  
San Francisco, CA  
415/777-5300  
[www.multicom.com](http://www.multicom.com)

**Virtual Knowledge**  
Needham, MA  
800/301-9545  
617/449-7567  
[www.virtualknowledge.com](http://www.virtualknowledge.com)

**Virtual Training Company**  
Santa Clara, CA  
888/872-4623  
408/492-1051  
[www.vtco.com](http://www.vtco.com)

**Voyager**  
New York, NY  
800/446-2001  
212/431-5199  
[www.voyagerco.com](http://www.voyagerco.com)

dark territory most feared by Macintosh users: Windows 95, as represented by Virtual Training Company's **Windows 95 Training CD** (♦♦♦, \$49.95 estimated street).

This hybrid CD-ROM provides a QuickTime introduction to Microsoft's omnipresent operating system. Users of Insignia's SoftPC and Connectix's Virtual PC can pause the CD-ROM's lessons to experiment with Windows 95. The disc gives a decent overview of Win 95's main features, but you'll get less-expensive, more-in-depth help from any of the Windows 95 books.

**Out of the Dark**

Despite persistent parental warnings to the contrary, my soul remains largely unscathed after my wicked wanderings. I've survived comic books, bathing beauties, propaganda, and even the dreaded Windows 95. Could it be that Mom and Dad were wrong about everything? Only one way to find out: My shoes are off, and despite threat of barefoot-induced pneumonia, I'm going outside for a walk on the wild side. ☹

Macworld Contributing Editor Christopher Breen isn't really wicked, he just writes that way.



# Andy Ihnatko



By Andy Ihnatko  
andyi@macuser.com

## Transitions

### Apple's moving on, and so are we

**TODAY, WE SHALL REFLECT** on Change and, perhaps more importantly, on the subject of Transition.

Change, after all, is a lot like History, or Art: You really can't observe it while you're inside it. Only 80 years later do we fully appreciate World War I as senseless prologue. *Soiled Underpants in Jello* might be the buzz of the art world today, but it won't really be Art until a hundred years from now when it's agreed that it's still worth cluttering up the Museum of Modern Art with.

Until the passage of time helps us separate the significant bits from the rest, we're stuck here balanced on these razor-thin moments of Transition that separate the past from the future.

Apple, at this moment, is up to its neck in transition. Let's count them all up. It's transitioning from an old, and in some ways antiquated, OS to Rhapsody. It's transitioning from a goal of a more open Mac OS, with cloning and support for CHRIP, to a more closed system. It's transitioning from a strategy that markets the

Mac as a have-all, do-all, be-all machine to one that bills it as The Critical Tool for education and creativity.

Apple is also transitioning back to "1984"-style commercials and ads. Well, this I enjoy. Like many of you, I tuned in to watch *Toy Story* there on ABC just to see the megahyped new Apple commercial. After the vaguely confusing series of personalities and quotes faded to the Apple logo, I turned to my friends there in the living room. "So you see," I explained,

"we Mac users, we're really a hell of a lot like Gandhi." They seemed to see the logic in this—it helped that I was making salt at the time—so score one for Chiat/Day.

Most interestingly, Apple is transitioning back to good-old-fashioned cage-match—style Godzilla Management. Steve Jobs as Godzilla, Larry Ellison as Gamera. No, no, I don't mean that the way it sounds. I mean that they're both big, towering, unmistakable individuals, and when they arrive, they bring excitement with them.

Amelio and his predecessors were more like the Horror of Party Beach and the rest of

those rubber monsters wandering through the movies on *Mystery Science Theater 3000*. They don't really think to do anything until the hunky lead and the young tomato of a girl reporter drop an A-bomb on them at the end. But Godzilla! Sure, you might not agree with his policies, but you can't say he doesn't keep himself busy!

But it's too easy to let ourselves wallow in this sort of thinking. Rhapsody, from all available evidence, is going to kick major butt, possibly leapfrogging any competition out there. Irrelevant. Rhapsody, it appears, will first be positioned as a server solution, not as a severe Pantsing to anyone running another operating system. Irrelevant. Clone licensees are no longer here to fill the role of the quick and agile organizations getting the hottest technology to the marketplace with Indy-car swiftness and agility. Will Apple still be able to claim that the fastest PCs on the planet run the Mac OS? Irrelevant. Apple is producing some of the best price/performance machines on the market. It's finding a place for Newton Technology again. Network Computers, though as-yet unproven, can be marketed by the technology's most powerful cheerleader, and they can be marketed under an Apple logo. Steve Jobs has switched from his Pixar wire-rims to contact lenses.

All irrelevant.

This is mere transition. It's time for us to stop worrying; to stop fetishistically charting Apple's progress as a series of changes and turmoils, of Events that may or may not affect stock performance.

We should return to that time when we didn't give a damn. To 1984, when the Mac was an unproven and unpopular machine with too little memory, no software, and one floppy drive for everything. To 1984, when on top of everything else, it was way too expensive. To 1984, when all we felt needed be said was "I use a Macintosh because it's the best there is at what I do." If I have to leave you with one thought, that's it.

#### Fade to Black

Which sort of brings us to the last bit of Transition: namely, of course, the transition of *MacUser* and *Macworld* into a new, unified magazine built from selected elements of both mags. Sadly, this is the last time I'll have the opportunity to address *MacUser's* readership en masse. I hope you understand how sincerely grateful I am that you've all been kind enough to give me your attention on a monthly basis for the past eight years. I am gratified that y'all had as much fun as I did. Special thanks to all of you who took the time to write; every letter and e-mail was appreciated. And to that guy who told me two years ago that his sweetie enjoys my writings so much that he reads them to her every month as foreplay, your message is still pinned to my wall and if there's anything I can do to ease this moment of Transition for you and Angie, my address remains andyi@world.std.com.

As the wise man said late at night a few years ago, I hope we all meet again some day, even though I'll be someplace else when we do. ☞

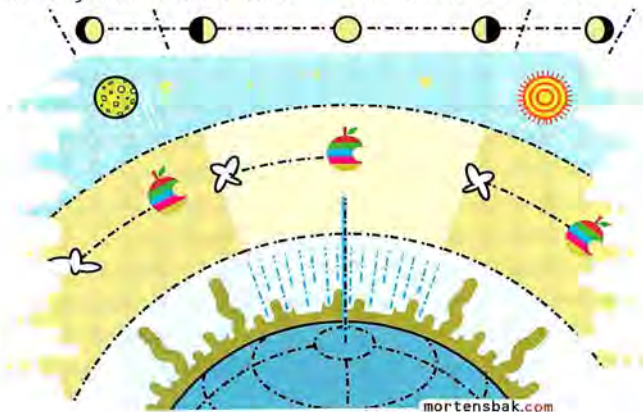



# Macworld Advertiser Index

Say you saw it in Macworld. To purchase products advertised in this issue call the phone numbers below or use the reader service number for our Product Information Card located after the product index.

Page No.	Advertiser	Reader Svc. No.	Phone	Page No.	Advertiser	Reader Svc. No.	Phone	Page No.	Advertiser	Reader Svc. No.	Phone
32	Adaptec	—	—	53	Infowave	32	800-663-6222	34,35	MetaCreations	5	800-846-0111
54	Agio Designs		800-688-2466					59	Microtek Labs, Inc.	—	800-654-4160
62	Alsoft	140	800-257-6381	7	IXMICRO	53	888-467-8282	IBC	Multi-Ad Services	187	800-447-1950
49	American Power Conversion	72	800-788-2208	154,155	J & R Computerworld	282	800-221-8180				
4	Anthro	—	800-325-3841	BC	Kensington Microware Ltd.	12	800-535-4242	29	NEC Technologies	019	800-NEC-INFO
9	ATI Technologies	256	—	5	Kingston Technology Corporation	201	800-435-0677	8	Orange Micro	33	714-779-2772
139	Bottom Line Distribution	37	800-990-5688	142	L. A. Trade	—	800-433-3726	86	Panasonic Communications Co.	60	—
140,141	Club Mac	96	800-CLUBMAC	IFC,1	La Cie	52	800-999-1332	158	Pro Direct	135	800-524-9952
152,153	Computer Discount Warehouse	2	800-509-4239	47	Mac Academy	106	800-527-1914	10,11	Ricoh	4	—
18,19	Connectix	192	—	156	Mac Connection	145	800-800-3333	36,37	Sony	—	888-552-7669
15	Denaba Software	57	800-733-6322	146,147	Mac Mall	131	800-222-2808	57	Symantec-Visual Page	151	—
16	Diehl Graphsoft	46	410-290-5114	61	Mac Soft	28	800-229-2714	113	Tektronix	—	800-835-6100
151	Digital Graphix	36	800-680-9062	63	Mac Soft	23	800-229-2714	159	The LLB Co.	—	800-848-8967
45	Epson America	—	800-BUYEPSON	65	Mac Soft	29	800-229-2714	143-145	The Mac Zone	71	800-436-0606
66,67	Epson America	—	800-BUYEPSON	92	Mac Soft	40	800-229-2714	76,77	Umax Computer	100	888-625-UMAX
97	Extensis	13	800-796-9798	116	Mac Soft	39	800-229-2714	20,21	ViewSonic	59	800-888-8583
85	Farallon Computing	—	510-814-5000	119	Mac Soft	30	800-229-2714	6	VST Technologies	73	508-263-9700
91	Fujitsu Computer Products of America	202	800-626-4686	121	Mac Soft	25	800-229-2714				
55	Hitachi NSA	74	800-441-4832	148,149	Mac Warehouse	150	800-434-3035				
				51	Maxell Corporation of America	120	—				
				150	MegaHaus	229	800-786-1184				







PRODUCT INFORMATION

Macworld puts you in touch with the information you need most with two easy options:

**1 dial 503.684.5370  
Fax In Card**

Simply fill in the questionnaire, circle the reader service numbers that correspond to the vendors you would like information from, then fax your form to us at 503.684.5370. FREE product information will be sent to you directly from vendors.

**2 postage pre-paid  
Mail In Card**

After filling in the questionnaire, circle the reader service numbers that correspond to the vendors you would like information from, then just drop the postcard in the mail. Vendors will send FREE product information directly to you.



**Check this box to subscribe to Macworld**

YOU WILL BE BILLED \$24 FOR A ONE-YEAR (12 ISSUE) SUBSCRIPTION (US ONLY). SUBSCRIPTION WILL BE SENT TO NAME AS NOTED BELOW. PLEASE CHANGE IF MAILING ADDRESS IS DIFFERENT.

**PLEASE ANSWER THESE QUESTIONS, CHECK ALL ANSWERS THAT APPLY**

1a. For which of the following Mac-related products do you specify, recommend, approve, purchase or influence the purchase?

1b. Which of the following do you plan to purchase in the next 12 months? (Check all that apply.)

- |   |                       |    |                       |
|---|-----------------------|----|-----------------------|
| Desktops/PowerBooks .....                   | <input type="radio"/> | 1  | <input type="radio"/> |
| Monitors .....                              | <input type="radio"/> | 2  | <input type="radio"/> |
| Printers .....                              | <input type="radio"/> | 3  | <input type="radio"/> |
| Storage Devices .....                       | <input type="radio"/> | 4  | <input type="radio"/> |
| Networking/Data Communications .....        | <input type="radio"/> | 5  | <input type="radio"/> |
| Internet/Intranet products/services .....   | <input type="radio"/> | 6  | <input type="radio"/> |
| Software: business/productivity .....       | <input type="radio"/> | 7  | <input type="radio"/> |
| graphics/design .....                       | <input type="radio"/> | 8  | <input type="radio"/> |
| interactive publishing/<br>multimedia ..... | <input type="radio"/> | 9  | <input type="radio"/> |
| entertainment .....                         | <input type="radio"/> | 10 | <input type="radio"/> |
| education .....                             | <input type="radio"/> | 11 | <input type="radio"/> |
| other software .....                        | <input type="radio"/> | 12 | <input type="radio"/> |
| Any other products .....                    | <input type="radio"/> | 13 | <input type="radio"/> |

2. Are you employed, and involved in purchase decisions for 5 or more Macs?  Yes (1)  No (2)

3. What's Your Opinion?

What are your main frustrations in making Mac-related purchase decisions?

- 1. Lack of expertise in assessing products
- 2. Difficulty in installing or using products
- 3. Too many choices
- 4. Not enough choices
- 5. Unclear needs
- 6. Concern that cheaper, better products are about to come out
- 7. Other (please specify) \_\_\_\_\_

**PRODUCT CATEGORY INFORMATION**

For information on all of the products mentioned in an article or an entire category of advertised products, circle the appropriate number below.

- 951 Mail Order Companies
- 952 Printers
- 953 Scanner & Digital Cameras
- 954 Online/Internet
- 955 Storage Devices
- 956 Monitors & Graphics Boards
- 957 Utilities
- 958 Clip Art & Fonts
- 959 Memory
- 960 Draw/Paint/DTP Software
- 961 Image-Editing Software
- 962 Other Graphics Software

READER SERVICE NUMBERS FOR ADVERTISED PRODUCTS CAN BE FOUND IN THE PRODUCT'S AD AND IN BOTH THE ADVERTISER INDEX AND PRODUCT INDEX.

1	2	3	4	5	146	147	148	149	150	291	292	293	294	295	461	462	463	464	465	531	532	533	534	535
6	7	8	9	10	151	152	153	154	155	296	297	298	299	300	466	467	468	469	470	536	537	538	539	540
11	12	13	14	15	156	157	158	159	160	401	402	403	404	405	471	472	473	474	475	541	542	543	544	545
16	17	18	19	20	161	162	163	164	165	406	407	408	409	410	476	477	478	479	480	546	547	548	549	550
21	22	23	24	25	166	167	168	169	170	411	412	413	414	415	481	482	483	484	485	551	552	553	554	555
26	27	28	29	30	171	172	173	174	175	416	417	418	419	420	486	487	488	489	490	556	557	558	559	560
31	32	33	34	35	176	177	178	179	180	421	422	423	424	425	491	492	493	494	495	561	562	563	564	565
36	37	38	39	40	181	182	183	184	185	426	427	428	429	430	496	497	498	499	500	566	567	568	569	570
41	42	43	44	45	186	187	188	189	190	431	432	433	434	435	501	502	503	504	505	571	572	573	574	575
46	47	48	49	50	191	192	193	194	195	436	437	438	439	440	506	507	508	509	510	576	577	578	579	580
51	52	53	54	55	196	197	198	199	200	441	442	443	444	445	511	512	513	514	515	581	582	583	584	585
56	57	58	59	60	201	202	203	204	205	446	447	448	449	450	516	517	518	519	520	586	587	588	589	590
61	62	63	64	65	206	207	208	209	210	451	452	453	454	455	521	522	523	524	525	591	592	593	594	595
66	67	68	69	70	211	212	213	214	215	456	457	458	459	460	526	527	528	529	530	596	597	598	599	600
71	72	73	74	75	216	217	218	219	220	<p><b>PLEASE PRINT OR TYPE ALL INFORMATION.</b> Expires April 25, 1998. 51 January 1998</p> <p><b>MR GARY VOGT</b> 5065 WALVERTON DR FLORISSANT MO 63033-4438</p> <p>E-mail _____ Title _____ Company _____ Phone _____ Fax _____</p>														
76	77	78	79	80	221	222	223	224	225															
81	82	83	84	85	226	227	228	229	230															
86	87	88	89	90	231	232	233	234	235															
91	92	93	94	95	236	237	238	239	240															
96	97	98	99	100	241	242	243	244	245															
101	102	103	104	105	246	247	248	249	250															
106	107	108	109	110	251	252	253	254	255															
111	112	113	114	115	256	257	258	259	260															
116	117	118	119	120	261	262	263	264	265															
121	122	123	124	125	266	267	268	269	270															
126	127	128	129	130	271	272	273	274	275															
131	132	133	134	135	276	277	278	279	280															
136	137	138	139	140	281	282	283	284	285															
141	142	143	144	145	286	287	288	289	290															

FREE

TWO SIMPLE WAYS TO GET



# TWO SIMPLE WAYS TO GET **FREE** PRODUCT INFORMATION

**Macworld**  
THE ESSENTIAL RESOURCE

**FREE**

Macworld puts you in touch with the information you need most with two easy options — fax back or mail in the reader service card.

Fax back. Mail in. Just don't miss out.

*Fold here and close with tape. Do not staple.*



50% TOTAL RECOVERED FIBER  
10% POST-CONSUMER FIBER



NO POSTAGE  
NECESSARY  
IF MAILED  
IN THE  
UNITED STATES

**BUSINESS REPLY MAIL**  
FIRST-CLASS MAIL PERMIT NO. 677 PORTLAND OR  
POSTAGE WILL BE PAID BY ADDRESSEE



**READER SERVICE DEPARTMENT**  
12950 SW PACIFIC HWY STE 7  
TIGARD OR 97223-9747





**Special Of The Month**

**\$95**

32MB 168-Pin DIMM

**\$189**

64MB 168-Pin DIMM  
5 Volt and EDO

**XL8**

**radius**

**BOTTOM LINE**

DISTRIBUTION

**iiyama**

**AGFA**

The one source for all your Macintosh needs.

<http://www.blol.com/macworld/> **1-800-990-5794**

Prices updated every 30 minutes!

**Media 100 QX**

**Professional Level**

**Digital Video Capture Card**

**\$1969**

\*Component System \$3795

**IX Micro Display/TV PCI Cards**

IX Micro 2MB VRAM .....\$149  
IX Micro 4MB VRAM .....\$219  
IX Micro 8MB VRAM .....\$499  
Turbo TV 125-Channel .....\$95

**Everyone Needs RAM**

All memory purchased from Bottom Line comes with a hassle free lifetime warranty!

**DIMMs 168-Pin 5.0/5.5 volt**

PCI PowerMac, UMAX, Power

8MB 168-Pin DIMM 60ns .....\$29  
16MB 168-Pin DIMM 60ns .....\$55  
32MB 168-Pin DIMM 60ns .....\$95  
64MB 168-Pin DIMM 60ns .....\$189  
512K L2 Cache DIMM .....\$99  
TW 1MB L2 Cache DIMM .....\$169  
1MB VRAM DIMM .....\$31

**DIMMs 168-Pin 3.3 volt**

Starmax, PowerTools, Apple 4400

16MB 168-Pin DIMM 60ns .....\$69  
32MB 168-Pin DIMM 60ns .....\$99

64MB 168-Pin DIMM 60ns .....\$209  
512K L2 Cache DIMM .....\$79

**SIMMs 72-Pin**

8MB SIMM 60ns .....\$29  
16MB SIMM 60ns .....\$55  
32MB SIMM 60ns .....\$95  
256K L2 Cache SIMM .....\$15.99  
1MB L2 Cache 61/71/8100 .....\$159

**Other Cache/VRAM**

6400/6360 512K L2 Cache .....\$99  
ATI 2MB VRAM Upgrade .....\$89.95  
1MB PCI VRAM DIMM .....\$27.95  
512K Cache DIMM .....\$99

Make sure to ask about our low business and personal leases from \$35/month

**Apple**

**\$3559** PowerMac 9600 604e/300Mhz

- 604e PowerPC 300Mhz
- 64MB RAM, 1MB Cache
- 24x Speed CD-ROM
- 4GB 5400RPM HD
- IMS 128 8MB VRAM
- Processor Upgradable
- 1-Year Warranty

**\$1859** PowerMac 7300 604e/180Mhz

- 604e PowerPC 180Mhz
- 16MB RAM, 256K Cache
- 12x Speed CD-ROM
- 2GB 5400RPM HD
- 2MB VRAM
- Processor Upgradable
- 1-Year Warranty

**\$2999** PowerMac 8600 604e/300Mhz

- 604e PowerPC 300Mhz
- 32MB RAM, 1MB Cache
- 24x Speed CD-ROM
- 4GB 5400RPM HD
- 2MB VRAM
- Processor Upgradable
- 1-Year Warranty

**\$1959** PowerMac 7300/200Mhz

- 604e PowerPC 180Mhz
- 16MB RAM, 256K Cache
- 12x Speed CD-ROM
- 2GB 5400RPM HD
- 2MB VRAM
- Processor Upgradable
- 1-Year Warranty

**Storage/Back-Up**

**Sony CD-R Drive \$99**

With Purchase of 100 pieces of CDR Media \$299.00 w/o media purchase

Quantum Fireball 2.1GB .....\$249  
Quantum Fireball 3.2GB .....\$339  
Quantum Fireball 6.4GB .....\$489  
Quantum Atlas II 4.3GB .....\$796  
Seagate Barracuda 4.55GB .....\$851  
Cheetah 4.55GB/9.1GB .....\$899/\$1447  
Sony Sony DDS-3 SDT-9000 .....\$1249  
SyQuest Syjet 1.5GB External .....\$389  
IBM Ultrastar 4.3GB F/W .....\$399  
IBM 9.1 GB 10K RPM AV .....Call

**Acceleration!**

**200Mhz/604e Processor Card XLR8 \$248**

Processor Upgrade card fits into 75176/83/9504s

TechWorks Power3D .....\$222  
XLR8 MACH Speed 200Mhz .....\$309  
XLR8 MACH Speed 225Mhz .....\$374  
XLR8 MACH Speed 233Mhz .....\$428  
PowerForce G3 250/250/1mb .....\$1949  
PowerForce G3 275/275/1mb .....\$2549  
MaxPower 225Mhz 604e .....\$779  
MaxPower Pro + w/512K Cache/1289  
PowerLogic Upgrades .....Call

**POWERtools New!**

**\$4899** X-Factor G3 750 starting at \$3999 149 month

- G3 Arthur Processor
- 80MB RAM, 512K Cache
- 24x Speed CD-ROM
- 9.1GB 7200RPM Av HD
- 4MB IX Micro, Kbd/Mse
- Processor Upgradable
- 1-Year Warranty

PowerTools is now shipping the fastest MacOS system in the world! This system is packed with performance and extra! The G3 Series "Arthur" processors are 3x's faster than the standard 604e offerings from Apple and UMAX.

- 250/275 Mhz G3 750 Arthur Processor
- 512K/1024K BackSide Cache
- 6-PCI Slots, Ultra SCSI-3 Fast/Wide
- 10BT/AAUI Ethernet & MacOS 8

The Fastest Mac By Far

**UMAX SuperMac S900L 604e/250Mhz \$3339**

- 604e PPC 250Mhz!
- 32MB RAM, 512K Cache
- 8x Speed CD-ROM
- 2GB 7200 RPM HD
- IMS 128 8MB, Zip
- Processor Upgradable
- 1-Year Warranty

**Radius PhotoDV \$479**

**MotoDV \$579**

**ATTO Is SCSI Ultra SCSI-3 PCI Fast Wide SCSI card W/Drive \$299**

**IBM 9.1GB AV \$799**

Internal .....799  
External .....879/929  
18GB RAID .....1659

**Agfa SnapScan \$279**

AGFA Snapscan 600 .....\$385  
AGFA Snapscan 600 Artline .....\$519  
AGFA StudioStar For Mac .....\$697  
AGFA StudioStar For PC .....\$697  
Agfa Arcus II Mac/PC .....\$1569  
AGFA Arcus II "Solo" .....\$1279  
AGFA DuoScan .....\$4199

**Miro DC30 PCI Digital Video Card \$669**

**Magic Yamaha 4x/6x Speed CD-R Drive External \$549**

Includes SCSI cable, terminator, Astarte Toast, 1Pc. media

**lomega**

**Kodak DC210 \$879.00**

Kodak DC 120 Camera .....\$759  
Kodak Digital Science DC-50 .....\$628  
Sony DSC-F1 Digital Camera .....\$690  
Sony Mavica w/Zoom .....\$689  
Olympus D320L .....\$899  
Olympus D600L .....\$1259  
Apple QuickTake 200 .....\$599

**Zip Drive Internal (Tan Color) \$149**

Zip/Jaz Internal Kits .....\$23  
Jaz Drive Internal (Tan Color) \$199  
Magic Jaz Drive External .....\$199  
Jaz Drive 1GB Carts, Singles .....\$87  
Jaz Drive 1GB Carts, Qty 5 .....\$79.99  
Zip Drive 100MB Cart, 10-Pack \$119

**ATI VR PCI \$259**

Includes Director v4.0

ATTO Express PCI Ultra Wide .....\$299\*  
Jackhammer PCI Fast/Wide .....\$379  
Adaptec 2940UW Fast/Wide .....\$295  
Targa 1000 PCI .....\$1899  
Targa 2000 PCI .....\$3299  
LC/PDS 2MB VRAM 630/LCIII .....\$239  
MacPacCase 2MB VRAM NUBUSS289

**Monitors**

Viewsonic 17GA .....\$609  
Viewsonic OptiQuest Q71 17" .....\$488  
Viewsonic 17EA-2 w/Speakers .....\$539  
Samsung SuynMaster 6NE 17" \$599  
Sony 200sf 17" Monitor .....\$719  
Sony 200sx 17" Monitor .....\$631  
Magnavox CM5600 21" .....\$1059  
Mitsubishi MC7515 19" .....\$1125  
Mitsubishi Pro 91XTM 21" .....\$1499  
Iiyama Visionmaster Pro 21 .....\$1459  
Iiyama Visionmaster 500 21" \$1559

**Printers**

**Apple Stylewriter 6500 \$489**

Apple Stylewriter 4100 .....\$242  
Apple Stylewriter 4500 .....\$343  
HP SM 600x600 12ppm Laser \$1599  
Epson Stylus Color 600 .....\$295  
Epson Stylus Color 800 .....\$397  
Epson Stylus Photo 6-Color .....\$489  
Epson Stylus 3000 11"x17" .....\$1769

**PowerBook 2400c/180 \$3299**

**PowerBook 3400c/240 \$4299**

**Modems**

USR Sportster 56k X2 .....\$144.95\*  
GV Teleport 56k X2/FLEX .....\$157.94  
Supra Express 56k .....\$129  
Supra Express 56k Voice .....\$139  
Sagem ISDN Geoport .....\$389

**PCMCIA Modems**

Viking Netlink 56k .....\$149  
Viking Netlink 33.6 .....\$109  
PowerPort Platinum Pro 56k .....\$359  
GV PowerPort 56k Modem .....\$259

\* <http://www.blol.com/rebate>

**PowerBooks/RAM**

1400cs 133Mhz 16/1.3/CD .....\$1999

**1400 RAM Modules**

**Newer Tech**

12MB .....\$97 16MB .....\$139  
16MB .....\$137 24MB .....\$189  
24MB .....\$209 32MB .....\$229

**Viking**

3400c/180 16/1.3/CD .....\$3059  
3400c/200 16/2/CD .....\$3399

**3400 RAM 5300 RAM**

32MB .....\$179 16MB .....\$99  
64MB .....\$399 32MB .....\$199  
128MB .....\$749 48MB .....\$299

**PowerBook 1400c/166 \$2679**

**Connectix Virtual PC \$138**

**PowerBook Extras**

Podium Strap-To-Leg .....\$49.95  
PB 1400 10BT Ethernet .....\$93.97  
PB 1400 8-Bit Video Out .....\$159.95  
PB 1400 Battery .....\$124  
PB 3400 Battery .....\$174  
Kensington Saddlebag .....\$69.99

**Favorite Software**

Quake For Mac \*In Stock\* .....\$45.95  
Kai's PhotoSoap .....\$43.79  
Quark Xpress v3.32 .....\$639  
Adobe Photoshop v4.0 .....\$469  
Adobe Illustrator v7.0 .....\$389  
QuarkXPress v4.0 .....\$751  
Freehand v7.0 Upgrade .....\$147  
MS Office v4.2.1 .....\$489  
FileMaker Pro v4.0 .....\$179  
Speed Doubler 8 .....\$53  
Norton Utilities v3.5 .....\$99

**Keyboards/Mice**

TurboMouse Mac/PC .....\$89.95  
Mouse-In-A-Box .....\$34.95  
Extended Keyboard & Mouse \$39.95  
Apple Extended Keyboard II .....\$149

**Scanners**

UMAX Astra 600s .....\$189  
UMAX Astra 1200s .....\$447/\$529  
UMAX PowerLook II w/Pshp .....\$1329  
Epson Expression 636 Upgrade .....\$719  
Microtek PageWiz Color .....\$159  
Microtek Scanner E3 .....\$194  
Microtek Scanmaker III .....\$1429  
Nikon CoolScan II Slide Scnr .....\$881  
Visioneer PaperPort Strobe .....\$297

**Removable Media**

SyQuest 44MB/88MB .....45/54  
SyQuest 200MB/270MB .....\$9/79  
CD-R 74Min .....Call  
Optical Media 128MB/230MB .....Call  
Jaz Media - (5 pack etc) .....\$79.99

<http://www.blol.com/macworld> Mac On! **1-800-990-5794**

Shipping: \$5, 5 lbs., 2 Days Payment; No surcharge on credit cards. Corporate POs welcome. Tax: Texas residents add 8.25% sales tax. Prices: Items, prices and availability subject to change. Returns: Call for RMA number. Must be in original condition, opened software is non-refundable. Subject to a restocking fee. Original shipping is non-refundable. Apple brand products are not returnable for refund. Bottom Line Distribution cannot be responsible for errors in typography or photography. Customer Service: 512-892-4090. International Sales: Bottom Line Distribution is committed to the needs of the international Macintosh user. We offer discounted rates with DHL. Delivery to most countries is 2 to 3 days. Dealer inquiries are welcome. Language interpreters available. Address: 4544 S. Lamar Blvd., #100, Austin, TX 78745

**BOTTOM LINE**



# CLUBMAC

# SHOCKS

PRICES SLASHED ON Quantum & Seagate

**STRATUS 2.1GB**

**BARRACUDA 4XL 4.5GB**

128K CACHE  
5400 RPM  
Internal

**\$229**

8.5MS Access  
7200 RPM  
Internal

**\$599**

**Quantum VIKING 4.5GB \$499**  
7200 RPM Internal

**Quantum ATLAS II 9.1GB \$879**  
7200 RPM Internal

**Quantum STRATUS 6.4GB \$449**  
5400 RPM Internal

**Seagate CHEETAH 4.5GB \$699**  
10000 RPM Internal

## HARD DRIVES

Quantum	Model	Access	RPM	Internal	External
Description: Quantum Stratus drives carry a 3 Year Warranty. Quantum Atlas & Viking drives carry a 5 Year Warranty.					
2.1GB Stratus	QM32160STS	10ms	5400	\$229	\$279
3.2GB Stratus	QM33240STS	10ms	5400	\$299	\$349
4.3GB Stratus	QM34320STS	10ms	5400	\$339	\$389
4.5GB Viking	QM34550VKS	8ms	7200	\$499	\$549
4.5GB Atlas II	QM34550ALS	8ms	7200	\$579	\$629
6.4GB Stratus	QM36480STS	10ms	5400	\$449	\$499
9.1GB Atlas II	QM39100ALS	8ms	7200	\$879	\$929
UltraWide SCSI-3					
2.2GB Viking	QM32275VKSW	8ms	7200	\$419	\$499
4.5GB Viking	QM34550VKS	8ms	7200	\$539	\$619
4.5GB Atlas II	QM34550ALS	8ms	7200	\$619	\$699
1.9GB Atlas II	QM39100ALW	8ms	7200	\$919	\$999
IDE Drives					
1.6GB Stratus	QM31620STA	10ms	4500	\$155	----
2.1GB Stratus	QM32160STA	10ms	4500	\$189	----
3.2GB Stratus	QM33240STA	10ms	4500	\$215	----
4.3GB Stratus	QM34320STA	10ms	4500	\$265	----
6.4GB Stratus	QM36480STA	10ms	4500	\$349	----

Seagate	Model	Access	RPM	Internal	External
Description: Seagate drives carry a 5 Year Warranty.					
4.5GB Barracuda 4XL	ST34572N	8.5ms	7200	\$599	\$649
4.5GB Cheetah	ST34501N	8ms	10000	\$699	\$749
1.9GB Barracuda 9	ST19171N	8ms	7200	\$1049	\$1099
9.1GB Cheetah	ST19101N	8ms	10000	\$1199	\$1249
UltraWide SCSI-3					
4.5GB Barracuda 4XL	ST24572W	8.5ms	7200	\$649	\$729
4.5GB Cheetah	ST34501W	8ms	10000	\$749	\$829
1.9GB Barracuda 9	ST19171W	8ms	7200	\$1089	\$1169
9.1GB Cheetah	ST19101W	8ms	10000	\$1199	\$1279
Fast SCSI-2					
23GB Elite 23	ST423451N	8ms	5400	\$1989	\$2089
Fast&Wide SCSI-2					
23GB Elite 23	ST423451W	8ms	5400	\$2089	\$2189

IBM	Model	Access	RPM	Internal	External
Description: 2.5" IDE HARD DRIVES					
1.6GB TravelStar	73H7693	13ms	4000	\$199	----
2.1GB TravelStar	73H7673	13ms	4000	\$259	----
3.0GB TravelStar	46H6144	13ms	4000	\$399	----

**THE CLUBMAC PACKAGE** ClubMac drives are preformatted and thoroughly tested. ClubMac drives include a 30-Day Money Back Guarantee, Charisma Anubis Formatting Utility software, user's guide, brackets (wide drives include internal ribbon cable), 25/50-pin SCSI cable and power cord for external drives (wide drives include 68/68 pin SCSI cable).

## TAPE BACK-UP

**ClubMac DDS-3 DAT Drive**  
12-24GB  
**\$1199**

CLUBMAC TAPE BACK-UP

- 4-8GB DDS-2 Compression DAT Drive \$799
- 4-8GB DDS-2 Performance DAT Drive \$899
- 12-24GB DDS-3 Lightning DAT Drive \$1199
- 15-30GB DLT Drive w/ Retrospect \$2699
- 20-40GB DLT Drive w/ Retrospect \$3189

**ClubMac 8mm AIT Drive**  
25-50GB  
Up to 6MB/Sec!  
**\$3449**

CLUBMAC AIT DRIVE  
25-50GB 8mm AIT Drive \$3449

**All ClubMac Tape Back-up Products are bundled with Retrospect 4.0**

RETROSPECT 4.0

- Retrospect 4.0 Retail Single User \$149
- Retrospect 4.0 Remote 10 User License \$175
- Retrospect Network Kit 4.0 (w/10 User license) \$275

**REMOVABLE**

Got a Second 1.5GB Cartridge FREE!

SyJet 1.5GB **\$399**

REMOVABLE DRIVES

ClubMac SyQuest 200MB 5.25"	\$349
SyQuest EZ Flyer 230MB 3.5"	\$149
SyQuest SyJet 1.5GB 3.5"	\$399
Nomai 750MB 3.5"	\$299

**SYQUEST MEDIA**

Media	Qty 1	Qty 10	Qty 20
44MB	\$38ea	\$37 <sup>50</sup> ea	\$37ea
88MB	\$38ea	\$37 <sup>50</sup> ea	\$37ea
200MB	\$59ea	\$58ea	\$57ea
270MB	\$43ea	\$42ea	\$41ea
EZ230MB	\$27ea	\$26 <sup>50</sup> ea	\$26ea
1.5GB SyJet	\$124 <sup>99</sup> ea	\$99ea	\$89ea

## CD READERS & RECORDABLES

**ClubMac 24X 24X CD-ROM**  
3600KB/sec data transfer  
90ms avg access time  
Caddy-less design  
**\$189**

CLUBMAC CD-ROM READERS

12X 140ms 1800k/sec	\$139
24X 90ms 3600k/sec	\$189
16X 5 Disc CD Changer	\$279

**ClubMac 4X/6X CD Recorder**  
**\$529**

CLUBMAC CD-RECORDERS

4X/6X CD-R w/Toast Pro 3.5	\$529
CLUBMAC CD-REWRITABLE	
2X/2X/6X CDRW w/Toast Pro 3.5	\$529

**THE CLUBMAC PACKAGE:** ClubMac CD-ROM & CD Recorders are thoroughly tested. CD-ROM & CD Recorders include a 30-Day Money Back Guarantee, Charisma CD AutoCache utility software, user's guide, 25/50-pin SCSI cable, terminator, and power cord.

**Zip Plus Drive**

Includes One Free Cartridge with Zip Tools

100MB **\$199<sup>95</sup>**

IOmega ZIP DRIVES

Zip Drive w/one cartridge	\$139 <sup>95</sup>
Zip Bundle - drive, 11 Disks, Case, 2 Caddy's	\$279*
Zip Drive Internal - all PowerMacs	\$159
Zip Drive Internal - all PowerComp/Umax	\$139

**Jaz 2GB Drive**

2.0GB **\$649**

Includes One Free Cartridge with Jaz Tool

IOmega JAZ DRIVES

Jaz 2GB Media	\$199
Jaz 2GB Drive Internal - all PowerMacs	\$549
Jaz Drive w/one cartridge	\$399
Jaz Drive Internal - all PowerComp/Umax	\$279

## IOmega JAZ AND ZIP MEDIA

**GET MORE STORAGE FOR YOUR STUFF!!!**

**ZIP MEDIA**

Format	Part#	Qty 1-2	Qty 3-6	Qty 7-9	Qty 10+
MAC	1040 1006	\$19 <sup>95</sup>	\$16 <sup>95</sup>	\$14 <sup>95</sup>	\$12 <sup>95</sup>
PC	1040 1009	\$19 <sup>95</sup>	\$16 <sup>95</sup>	\$14 <sup>95</sup>	\$12 <sup>95</sup>

**1GB JAZ MEDIA**

Format	Part#	Qty 1-2	Qty 3-5	Qty 6+
MAC	1040 1015	\$124 <sup>95</sup>	\$99 <sup>95</sup>	\$84 <sup>95</sup>
PC	1040 1037	\$124 <sup>95</sup>	\$99 <sup>95</sup>	\$84 <sup>95</sup>

**CALL 1-800-260-8549 FOR A FREE CATALOG**

WARRANTIES: All items manufactured by ClubMac are returned to ClubMac for warranty repair. All other items carry manufacturer warranty. MONEY BACK GUARANTEE: All products manufactured by ClubMac carry a 30 day money back guarantee. ClubMac carries all other manufacturers' return policies to its customers. Non-ClubMac products carry 30 day money back guarantee when specified. RETURNS: Call for RMA number! Any product that is returned WITHOUT an RMA number will be refused. ALL PRODUCT INFORMATION AND PRICES ARE SUBJECT TO CHANGE WITHOUT NOTICE. NOT RESPONSIBLE FOR TYPOGRAPHICAL ERRORS.



# THE WORLD!



Authorized Catalog Reseller

## PRICES SLASHED ON EVERY APPLE CPU

**\$300 Rebate!**  
When purchased with ANY Apple Display.

### PowerMac 8600 PowerMac 9600

**\$2896\* \$3597\***

- 300MHz 604e PowerPC™
- 24X CD ROM
- 1MB L2 Cache
- 32MB RAM
- 4GB HD
- Zip Drive



**64MB RAM**

### PowerBook 3400

12.1" Active Matrix  
As fast as 240MHz 603e  
Up to 3GB Hard Drive  
2X CD ROM

Starting at **\$2997**

**FREE 32MB RAM or QuickTake Camera** with ANY Camera purchase.

**2X CD**

### PowerBook 1400

Up to 11.3" Active Matrix  
As fast as 166MHz 603e  
Up to 2GB Hard Drive  
8X CD ROM

Starting at **\$1949**

**8X CD**

### PowerMac 6500

Up to 300MHz 604e PowerPC™  
Up to 64MB RAM  
Up to 24X CD  
Up to 6GB HD

Starting at **\$1492**



PowerBook 3400c 180MHz 603e, 1.3GB HD, 12X CD, 12.1" Active Matrix, 33.6 Modem.....	\$2997
PowerBook 3400c 200MHz 603e, 2GB HD, 12X CD, 12.1" Active Matrix, 33.6 Modem.....	\$3593
PowerBook 3400c 240MHz 603e, 3GB HD, 12X CD, 12.1" Active Matrix, 33.6 Modem.....	\$4263

PowerBook 1400CS 133MHz 603e, 16MB RAM, 1.3GB HD, 8X CD, 11.3" Dual Scan.....	\$1949
PowerBook 1400C 133MHz 603e, 16MB RAM, 1.3GB HD, 8X CD, 11.3" Active Matrix.....	\$2568
PowerBook 1400C 166MHz 603e, 16MB RAM, 2GB HD, 8X CD, 11.3" Active Matrix.....	\$2852

6500/225MHz 603e, 32MB, 3GB HD, 12X CD, 33.6 Modem.....	\$1492*
6500/250MHz 603e, 32MB, 4GB HD, 24X CD, 56K Modem.....	\$1874*
6500/275MHz 603e, 32MB, 6GB HD, 24X CD, 56K Modem, Zip.....	\$2356*
6500/275MHz 603e, 48MB, 6GB, 24X, 56K Zip, Business Software.....	\$2635*
6500/300MHz 603e, 64MB, 6GB HD, 24X CD, 56K Modem, Zip.....	\$2796*

### MONITORS

**SONY Trinitron 155X**  
Variable Aperture Pinch  
**\$259**

son 100SX 15", 1024x768	\$339
son 100SF 15", 1024x768	\$389
son 200SX 17", 1024x768	\$625
son 200SF 17", 1152x870 on screen disp.	\$699
son 20SF2 20", 1280x1024	\$999
son 300SF 20", 1280x1024	\$1749

### GRAPHIC CARDS

**Nexus GA™ 8MB**  
**\$529**

Nexus GA™ 8MB 2D & 3D Pro PCI	\$529.00
3Claim VR™ 4MB PCI graphics card	\$244.25
3Claim TV™ Tuner	\$82.00

### MODEMS

**BEST DATA 33.6KFLXMAC Data Fax Modem**  
**\$49.99**

GLOBAL VILLAGE Teleport 56K Fax/modem	\$149**
Teleport 56K Fax/modem w/X2 technology	\$149**
56K PCMCIA Combo Card	\$359

### SOFTWARE

**Mac OS 8 It's Here!**  
Upgrade for **\$65.99**

APPLE System 8.0 CD upgrade	\$65.99
System 8.0 CD w/AICX	\$94.99
Apple Remote Access MultiPort Server V.2.1	\$699.00

### PRINTERS

**All EPSON Printers are in stock Now!**

EPSON Epson Stylus Color 600 1440 DPI	\$269
Epson Stylus Color 800 1440 DPI	\$399
Epson Stylus Color Photo 6 COLOR	\$499
Epson Stylus Color 3000 17.2" 22" 1440 DPI	\$1999

### SCANNERS

**PaperPort Vx \$99!**

Visioneer PaperPort Vx w/FREE SCSI adapter	\$99*
PaperPort Strobe color!	\$279*

### ACCELERATORS

**MaxPower PRO** - PowerPC 750 Upgrade  
**\$1269**

Microtek Scanmaker III w/tran adapter	\$1389
Microtek Scanmaker E6 w/Photoshop	\$529
Microtek Scanmaker V3000	\$149
EPSON Epson Perfection 600	\$299

### UPGRADE YOUR MEMORY TODAY!

72pin SIMMS	POWERBOOK MEMORY	30pin SIMMS
24 8MB \$42	3400 SERIES	4MB 4 x 6 SIMMS \$32
69 32MB \$139	16MB \$129	2MB VRAM (ATI XClaim GA) \$85
68pin DIMMS	64MB \$159	4MB5GRAM 4400/Stamux \$89
24 16MB \$84	1400 SERIES	1MB VRAM 7200 - 8500 \$33
65 64MB \$339	16MB \$135	

### UPGRADE YOUR MEMORY TODAY!

64MB DIMM memory as low as \$24
---------------------------------

### UPGRADE YOUR MEMORY TODAY!

2MB VRAM (ATI XClaim GA) \$85
4MB5GRAM 4400/Stamux \$89
1MB VRAM 7200 - 8500 \$33

Customer Service (800) 260-8549  
Sales & International Sales (714) 768-8130  
Fax (714) 768-9354

Corporate/Educational Sales (800) 258-2621  
Technical Support (800) 854-6227

E-Mail: ClubMac Sales...csmsales@club-mac.com  
Customer Service...custsvc@club-mac.com  
Technical Support...techsup@club-mac.com  
Mail: ClubMac...7 Hammond, Irvine, CA 92618

Source Code 690198

### UMAX SuperMac C500!

**200MHz PowerPC ONLY \$995**

C500i 200MHz 603e, 16MB, 2GB HD, 12X, 33.6, \$1200 Software.....	\$1095*
C500e 200MHz 603e, 16MB, 2GB HD, 12X, Ethernet, \$1200 Software.....	\$1095*

**FREE SCANNER UMAX Astra 600S**  
Free with Purchase of any C600 System

C600 200MHz 603e, 16MB, 2.1GB HD, 8X CD, 33.6.....	\$1195*
C600 240MHz 603e, 24MB, 2.1GB HD, 8X CD, 33.6.....	\$1395*
C600x 240MHz 603e, 32MB, 3GB HD, 12X CD, 33.6, Ethernet.....	\$1795*
C600x 280MHz 603e, 32MB, 4GB HD, 12X CD, 33.6, Ethernet.....	\$2095*

# ClubMac®

**ORDER TODAY! 24 HOURS A DAY 7 DAYS A WEEK**  
**1-800-260-8549**  
Order On-line @ <http://www.club-mac.com>



WE WILL TRY TO MATCH OR BEAT ANY ADVERTISED PRICE. CALL FOR LATEST PRICING!!

WE ACCEPT PO'S FROM QUALIFIED FIRMS

# M E M O R Y

SECURITY WILL CALL WINDOW NOW OPEN!  
NO SURCHARGE FOR MC, VISA AE & DISCOVER

L.A. Trade has served the PC market for 10 years...

## MACINTOSH MEMORY UPGRADES

Now we bring our expertise to the Apple Macintosh user.

YOUR MACHINE	STANDARD	MAX	VIDEO UPGRADE	VIDEO COST	256K/512K/1MG	2MB	4MB	6MB	8MB	10MB	12MB	16MB	20MB	24MB	32MB	48MB	64MB	128MB
Apple PowerBook 190, 190CS	4/8	36/40					42		64			109			199			
Apple PowerBook 520, 520c, 540, 540c Notebook	4	36					49		39		89	99		149	169			
Apple PowerBook DUO 210, 230, 250 Notebook	4	24					49	65	39	79	89	109	129	28-159				
Apple PowerBook DUO 270c Notebook	4	32					49	65	39	79	89	109	129	28-159				
Apple PowerBook DUO 280, 280c Notebook	4	40					49	65	39	79	89	109	129	28-199	36-229			
Apple PowerBook DUO 2300c/100 Notebook	8/20	56							39	79	89	109	129	199	199	299		
Apple PowerBook 1400	12/16	60/64								74		119		179	199	299		
Apple PowerBook 2400										49		99		179			419	
Apple PowerBook 3400G EDO										79		109		189	199	299	392	738
Apple PowerBook 5300 Series	8/16/32	56/64								79	119	109		149	189	289		
Apple Macintosh TV	5	8					20											
Apple Macintosh IIfx (64 pin)	4	128					119					179					469	
Apple Macintosh IIfx	2/3/5	17					40		60			104						
Apple Macintosh IIfx & IIfx	4	68	512k	59			40		60			104					469	
Apple Macintosh Classic II, LC, LCII	2/4	10	512k	59		20	30		56									
Apple Macintosh LCIII, LC475, LC550, LC575, LC580	4	36	256k	34			20		44			64			169			
Apple Macintosh LC520	5	36					20		44			64			169			
Apple Macintosh LC580	4	48					20		44			64			169			
Apple Macintosh LC499	4	36					20		44			64			169			
Apple Macintosh LC5200	8	64					20		44			64			169			
Apple Macintosh LC630	5	36					20		44			64			169			
Apple Macintosh IIfx	1/5	128					40					119			208		469	
Apple Macintosh II, IIfx, IIfx (w/Pal)	1	32					48		124			149			298			
Apple Macintosh SE30	1/2	32					40		96			119			238			
Apple Performa 400	4	10	512k	68		22	30		56									
Apple Performa 405, 410, 430	4	10	512k	68		22	30		56									
Apple Performa 450, 460, 466, 467, 475, 476	4	36	256k/512k	34/68			20		44			99			129			
Apple Performa 550, 560, 575, 577, 578, 580	5	36	256k	34			20		44			99			129			
Apple Performa 600, 600CD	5	68	512k	59			40					119					469	
Apple Performa 6110CD, 6112CD, 6115CD (pairs)	8/16	72					20		44			64			129			
Apple Performa 6117CD, 6118CD (pairs)	8/16	72					20		44			64			129			
Apple Performa 630, 630CD, 636	4	36					20		44			64			129			
Apple Performa 631CD, 636CD, 640CD	8	52					20		44			64			129			
Apple Performa 635CD	5	36					20		44			64			129			
Apple Performa 637CD, 638CD	8	36					20		44			64			129			
Apple Performa 5200 Series 5200CD, 5215CD, 5300	8/16	64					20		44			64			129			
Apple Performa 6100 Series 6116CD (pairs)	8/16	72					20		44			64			129			
Apple Performa 6200 Series 6200CD, 6216CD, 6218CD	8	64					20		44			64			129			
Apple Performa 6200 Series 6220CD, 6230CD, 6290	8	64					20		44			64			129			
Apple Performa 6205CD, 6214CD	8	64					20		44			64			129			
Apple Performa 6300CD, 6320	16	64					20		44			64			129			
Apple Performa 6400CD, 6360 (2K Refresh)	16	136			94												259	
Apple Centris 610, 650, 660 AV	4	132	512k	59			20		44			64			129			
Apple Quadra 605	4	36	512k	59			20		44			64			129			
Apple Quadra 610	4	68	256k	34			20		44			64			129			
Apple Quadra 630	4	36					20		44			64			129			
Apple Quadra 650	4/8	132/136	256k	34			20		44			64			129			
Apple Quadra 660AV	4	68					20		44			64			129			
Apple Quadra 700	4	68	256k	34			48					104					469	
Apple Quadra 800 (pairs)	8	136	512k	59			20		44			64			129			
Apple Quadra 840AV	8	128	512k	59			20		44			64			129			
Apple Quadra 900	4	256	512k	59			48					104					469	
Apple Quadra 950	8	256	512k	59			48					104					469	
Apple Workgroup Servers	8	136	256k	34					Call			Call			Call			
Power Macintosh 4400/160	8	72	2M/4M	59/79	89/119							84					259	
Power Macintosh 5200, 5260, 5300	16	136			89/119		20		44			84			129			
Power Macintosh 5400	8	136			89/119							84			139		259	
Power Macintosh 6100/80, 6100/66, 6100/66AV (pairs)	8/16	72			29/-		20		44			64			129			
Power Macintosh 6200/75	8/16	72			29/-		20		44			64			129			
Power Macintosh 6400/200	8/16	72			89/119		20		44			84			139		259	
Power Macintosh 6500/225, /250, /275, /300 (Edo)	8/16	72			29/-		20		44			84			139		259	
Power Macintosh 7100/66, /100/80, /100/66AV (pairs)	8/16	136	512k	59	29/-		20		44			64			129			
Power Macintosh 7200/75, /90, /120, /120PC	8/16	256	1mg	49	59/89/209							84			139		259	
Power Macintosh 7300/166, /180, /200, /7500/100	8/16	256/1gig	1mg	49	59/89/209							84			139		259	
Power Macintosh 7600/100, /120, /132, /200	8/16	1gig/512	1mg	49	59/89/209							84			139		259	
Power Macintosh 8100/80, /100, /110	8/16	264	512k	59	29/109		20		44			64			129			
Power Macintosh 8100/80AV, /100AV, /110AV (pairs)	8/16	264	512k	59	29/109		20		44			64			129			
Power Macintosh 8500/120, /132, /150, /180	8/16	1gig/512	1mg	29	59/89/209							84			139		259	
Power Macintosh 8600/200, /233	8/16	1gig/512	1mg	49	59/89/209							84			139		259	
Power Macintosh 9500/120, /132, /150, /180MP, 200	16/32	768/1.5 gig	2mg	62								84			139		259	
Power Macintosh 9600/200, /233, /200MP	8/16	768	2mg	87								84			139		259	
Color Laserwriter 12/600 PS																		89
Color Laserwriter 12/640 PS																		64
Color Laserwriter 16/600 PS																		89
Motorola Starmax 3000 EDO/160, 200; 4000/160, 200	16/32																	149

NEW 168 Pin EDO 3.3V Dimms Call!

**UMAX MEMORY**

C500/140, 160, 180	8/16/32/64 meg	49/89/139/279
C600/180, 200, 240	8/16/32/64 meg	49/89/139/279
J700/150, 180	8/16/32/64	49/89/139/279
S900/150, 180, 200, 225 (pairs)	8/16/32/64/128 meg	49/89/139/279/879
S900 dp/180, 200 (pairs)	8/16/32/64/128 meg	49/89/139/279/879

**Flash Memory for Apple Newton**

4 Meg	139
8 Meg	129
16 Meg	239
20 Meg	276
32 Meg	379
48 Meg	649
64 Meg	829

CHECK OUT OUR WEBSITE FOR APPLE BATTERIES!!!

**CALL FOR NEW MODELS NOT LISTED**

All products brand new & guaranteed • We buy excess inventory  
Trademarks are registered with their respective companies.



22825 Lockness Avenue • Torrance, CA 90501  
CUSTOMER SERVICE & TECHNICAL: OPEN M-F, 9-4 PST

**POWER COMPUTING**

POWER 80, 100, 110, 120	8MEG	16 MEG	32MEG	64MEG
POWER CENTER 120, 132, 150, 166, 180	49.00	91.00	149.00	289.00
POWER CURVE 601/120	49.00	91.00	149.00	289.00
POWER TOWER 166/180	49.00	91.00	149.00	289.00
POWER TOWER PRO 180, 200, 225	49.00	91.00	149.00	289.00
POWER WAVE 604/120	49.00	91.00	149.00	289.00
POWER WAVE 604/132, 150	49.00	91.00	149.00	289.00
POWER COMPUTING POWER BASE (EDO)	CALL	CALL	CALL	CALL

NO SURCHARGE FOR MASTERCARD, AMEX, VISA OR DISCOVER. PURCHASE ORDERS ACCEPTED FROM FOREIGN GOVERNMENT & INSTITUTIONS. California orders add 8.25% sales tax. Returned orders or incorrect wrong parts are subject to a 20% restocking fee. We accept international orders shipped via UPS Air, APO, FPO orders welcome. Customers are expected to pay customs and "other" charges if shipped int'l. All credit card charges verified for fraudulence only. SORRY, NO REFUNDS AFTER 30 DAYS - EXCHANGES ONLY. If you receive defective merchandise we exchange only - no returns. We accept MC, VISA, Discover, A.E. prepaid orders, purchase orders, wire transfer, OOD (cashiers check) orders. Orders shipped by UPS. FEDEX must be signed for. \*ALL MANUFACTURER PART #S ARE FOR REF. ONLY - MINIMUM ORDER \$40.00 - NO REFUNDS ON SHIPPING.

310-539-0019  
FAX: 310-539-5844

SECURITY WILL CALL WINDOW NOW OPEN

CALL TOLL FREE

**1-800-433-3726**  
(US and Canada)

ESTAB. 1985

Prices & Availability Subject to Change Without Notice

Mon-Fri, 8:00 a.m. to 5:00 p.m. PST  
Sat. 10:00 a.m. to 12:00 noon

www.4LTrade.com

e-mail: sales@latrade.win.net



PROUDLY SERVING MAC USERS SINCE 1986

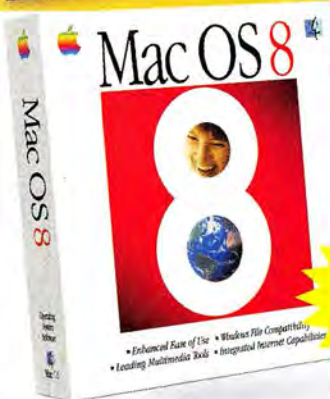

## 3 GREAT MAC OS 8 BUNDLES!

### Mac OS 8

- Multitasking Finder saves you valuable time
- Live scrolling for greater page file control
- "Connect To" shortcut to visit Web sites or launch browser

#75302 Mac OS 8 (Full Version) . . . \$98.98

The most affordable and portable storage solution

Incredible LOW PRICE!

ONLY \$134.95 #91825



### Omega Zip® Drive

- Unlimited storage on inexpensive 100MB disks
- Easy plug-and-go setup to SCSI connector
- Totally compatible with Mac OS and DOS/Windows

A revolutionary breakthrough in Photo Quality inkjet printing!

NEW LOW PRICE!

ONLY \$269.98 #80667



### EPSON Stylus Color 600

- Brilliant Photo Quality 1440 dpi output – perfect for today's home or office!
- Up to 6 ppm black, 4 ppm Photo Quality color
- QuickDry fast-drying inks
- 100-sheet paper capacity, up to legal size



ONLY \$99.98\* #50804

### Mac OS 8 and Quicken Deluxe 98

Your Mac does more with OS 8 and your money goes further!

\*After \$30 Claris mail-in rebate (Mac OS 8 Upgrade for owners of Mac OS 7.6 ONLY) and \$20 Intuit mail-in rebate (Quicken Deluxe 98). Low Zone Bundle price \$149.98.



ONLY \$179.98\* #75359

### Mac OS 8 and Omega Zip Disk 10-Pack plus FREE Zip Disk with preloaded software

\*After \$20 Omega mail-in rebate. Low Zone price \$199.98.

HURRY WHILE SUPPLIES LAST!



ONLY \$179.98 #73511 & #73512

### Mac OS 8 and Global Village TelePort 56K Modem†

#73511 TelePort 56K\* K56Flex Faxmodem with Mac OS 8 . . . . . \$179.98

#73512 TelePort 56K\* X2 Faxmodem with Mac OS 8 . . . . . \$179.98

\*Capable of downloading at 56 Kbps; however, current FCC regulations limit transmission to 53 Kbps. †Product shipped in promotional packing. Retail box not included

Powerful Web authoring for Mac users – no HTML required!

**\$40 REBATE!**

Low Zone Price \$135\*\*  
 Mfr. Mail-in Rebate - \$40\*\*  
**Your Price After Rebate \$95.98**  
 Offer Expires 6/1/98 #83320

Microsoft FrontPage 98

### Microsoft FrontPage 98 for the Macintosh

- The Web made easy with database access and ActiveX support
- Complete tools, featuring Internet Explorer 3.0 and HTML editing

Improved productivity and creative experimentation!

ONLY \$164.98 #76736

Adobe Photoshop 4.0.1 Upgrade

- Batch-process files with a single click
- Experiment more easily with color correction and effects
- Navigate large images dramatically faster
- A wealth of new creative effects, including 48 new filters

**FREE!**

Vertigo's Dizzy Included

A \$90 Value! While supplies last!  
 \*Plus \$2.95 for shipping and handling.

SAVE \$20 on this Great NEW Bundle!

ONLY \$159.98 #72135

### Performantz 8X CD-ROM Drive AND Riven: The Sequel to Myst

- 1200K/second data transfer rate; 1368.8K/sec. in mode 2
- Super-fast 145ms average access time
- 256K data buffer for smooth performance
- Multisession Photo CD and MPC 2 compliant
- Includes CD-ROM acceleration software
- A whole NEW world beyond Myst\*
- Over 60 hours of gameplay on 5 CDs
- 4,000 breathtakingly realistic images
- Astonishing live-action and animation sequences
- Two hours of haunting ambient music by creator Rand Miller

#74166 Riven: The Sequel to Myst . . . . . \$49.98

Breakthrough pricing on 30-bit scanning!

NEW!

ONLY \$159.98 #53948

UMAX Astra 600S SCSI-2 Color Scanner

Optical Resolution: 300x600 dpi  
 Max. Resolution: 4800x4800 dpi  
 Max. Scan Size: 8.5x14"  
 Color Bit Depth: 30-bit  
 Scan Method: Single-pass, color CCD

NEW! Video out and removable media

640x480 resolution!

ONLY \$499.98 #50571

Olympus D-220L Digital Camera

- Direct connection to TV/VCR for family viewing
- Both optical and electronic viewfinders
- Bright 2" actual image color LCD
- Includes Adobe PhotoDeluxe and InMedia Slides & Sound

Ordering from The Mac Zone is Easy!

Shop online at

www.maczone.com

SOURCE CODE MW801

# 1-800-436-0606

Circle 71 on your reader service card





# Your Macintosh® Catalog SuperStore™

PROUDLY SERVING MAC USERS SINCE 1986

## BLOWOUT SPECIAL!



Nokia 447W  
17" Multimedia Monitor  
(15.9" viewable)  
**ONLY \$449<sup>98</sup>**  
with any CPU purchase!\*

- 0.26 dot pitch
- Maximum resolution 1280x1024 at 79Hz
- Integrated 2-watt speakers and microphone
- On-screen menu

#47499 Nokia 447W 17" Monitor . . . \$499.98  
\* Must be on same invoice.



**NEW!**

**ONLY \$69<sup>98</sup>**

**100% Mac/PC Compatibility**

**Run Windows applications and games on your Power Mac!**

RealPC

- MS DOS 6.22 pre-installed and ready to run
- Full Sound Blaster Pro and Sound Blaster 16 compatibility
- Full support for Video 7 SVGA, VEGA and DirectX graphics

**16MB SIMMS \$59<sup>98</sup>**  
**WHILE SUPPLIES LAST!**

## UMAX® Power and expandability The Magic of Color™ for your small office!



**SUPERmac**

**ONLY \$1195**  
#81532

Monitor sold separately.

### SuperMac C600/200 Computer

- Upgradable PowerPC® 603e running at 200MHz
- 16MB RAM, expandable to 144MB
- Spacious 2.1GB lightning-fast IDE hard drive
- 8X CD-ROM drive
- 256K Level 2 cache
- 1MB VRAM
- 3 PCI expansion slots
- External and internal Fast SCSI connector
- Two high-speed serial ports

# Shop The Mac Zone ONLINE!

[www.maczone.com](http://www.maczone.com)

- All the latest products for your Mac – over 12,000 to choose from anytime!
- Weekly specials and blowout savings!
- Our special section for Mac Advocacy – industry news, hot tips and tons more!
- Our Vendor Spotlights area showcases hot new technology from top developers!
- Special promotions and product offers exclusively for our online customers!
- Enter to win Cool Prizes at *Riddle du Jour!*
- All this and more in a user-friendly, 100% secure shopping environment!



Corporate Sales 1-800-258-0882  
Government Sales 1-800-372-9663  
Education Sales 1-800-381-0882  
International Sales 1-206-430-3750

A NASDAQ® COMPANY Ticker Symbol: MZON

Copyright © 1997 • The Mac Zone® is a registered trademark of Multiple Zones International, Inc. All rights reserved.

### THE MAC ZONE • TRUSTED INTERNATIONALLY

- Australia • Austria • Belgium • Brazil • Central America • Chile • Colombia • Denmark • France • Germany • Holland • Hong Kong • Indonesia • India • Israel • Italy • Japan • Kenya • Mexico • New Zealand • Poland • Portugal • Singapore/Malaysia • Spain • Sweden • Switzerland • UAE/Middle East • United Kingdom • Venezuela





# We Carry the Full Line of Apple® Macintosh® Computers

- Over 6000 Products to Choose From!
- Cool Bundles and Hot Specials!
- Low Prices Everyday!
- Overnight Delivery only \$3 (up to 2 lbs)

**we're open**  
**24** hours a day  
**7** days a week



**CALL FOR YOUR FREE CATALOG!**

### The latest from Apple!

#### Apple® Power Macintosh® 7700 Series

- NEW! 233/266 PowerPC G3 processor
- 32MB RAM, supports up to 192MB
- 4GB hard drive
- 24X CD-ROM drive
- 66MHz system bus speed
- 117/133 backside bus speed
- 2MB video SG RAM
- IDE hard disk drive

**AS LOW AS**  
**\$1999**  
 #77039



Monitor sold separately.

#77040 Power Macintosh 7700/266 ..... \$2499.00

### Superior Performance Plus MS Office!

#### Apple® Small Business Power Macintosh® 4400/200

- 200MHz PowerPC® 603e processor
- 32MB RAM, expandable to 160MB
- 2.0GB hard drive
- Built-in 12X CD-ROM drive
- 33.6/14.4 Kbps data/fax modem
- Two PCI slots
- High-quality 16-bit stereo sound

**ONLY**  
**\$1599**  
 #78171



Monitor sold separately.

**Incredible LOW PRICE!**  
 While Supplies Last

### The performance and expandability for creative professionals!

#### Apple® Power Macintosh® 9600/300

- Super-fast 300MHz PowerPC® 604e processor
- 1MB inline cache
- 64MB RAM, expandable to 768MB
- 4GB Fast SCSI hard drive
- Built-in 100MB Iomega Zip drive
- 24X CD-ROM drive
- 16-bit stereo audio input and output
- 8MB IXMICRO Twin Turbo graphics accelerator
- LocalTalk™/10Base-T and AAUI-15 networking
- 6 PCI expansion slots and 7 drive bays

~~WAS \$4599~~  
**NOW ONLY \$3799**  
 #74726

**\$800 PRICE DROP!**



Monitor sold separately.

### The ideal big screen view for business users

#### Apple® Multiple Scan 1705 Display (17" - 15.8" viewable)

- 0.28mm dot pitch
- Maximum resolution of 1024x768 at 75Hz

**BLOWOUT PRICE!**  
 While Supplies Last

**ONLY \$549<sup>99</sup>**  
 #87875



## WIN A LIMITED EDITION 20TH ANNIVERSARY MACINTOSH!



### Official Sweepstakes Rules:

- No purchase necessary.** To enter the contest, please complete the entry form on this page (Mac Zone catalog back page or Macworld ad), or on our Web site at [www.maczone.com](http://www.maczone.com), or hand-print your name, company name, and address (including zip code) and mail in an envelope to: Mac Zone Holiday Sweepstakes, 707 S. Grady Way, Renton, WA 98055-3233. Sweepstakes entries will be void if incomplete, illegible or erroneous.
- Participation.** Sweepstakes contest begins on October 15, 1997, and is open only to U.S. residents who are 18 years or older. Employees of Multiple Zones International, Inc. and its affiliates or subsidiaries, and their immediate family members and/or those living in the same household are not eligible to participate. Sweepstakes limited to one entry per street or e-mail address. Mailed entries must be postmarked by January 31, 1998; electronic entries must be received by 5:00 p.m. PST, January 31, 1998.
- Validation.** The winner will be selected at random on February 28, 1998, and results will be announced on our Web site ([www.maczone.com](http://www.maczone.com)) on March 1, 1998. The winner will also be notified by mail. You may also get this information by sending a separate, stamped, self-addressed #10 envelope after March 1, 1998, to: Multiple Zones 20th Anniversary Macintosh Sweepstakes Winner, 707 S. Grady Way, Renton, WA 98055-3233. The judges' decision will be final.
- Prizes and Odds.** One (1) Grand Prize of a 20th Anniversary Macintosh Computer. Odds of winning will depend on number of eligible entries received. No prize substitution or transfers will be permitted.
- Other Rules.** All submissions become property of Multiple Zones International. Sweepstakes valid only in the U.S., and subject to all applicable laws. Void where prohibited by law. All sweepstakes entrants, by participating in the contest, agree to be bound to these Official Sweepstakes Rules.
- Disclaimers.** Multiple Zones International, Inc. hereby disclaims any responsibility for lost, late, stolen, interrupted, misdirected or unrecieved mail or electronic transmissions; technical, hardware, software, telephone, Web site or Internet problems or failures of any kind; computer viruses or bugs; or any injury or damage to any computer resulting from participation in sweepstakes or downloading of materials.

CLIP HERE AND MAIL YOUR ENTRY TODAY!

## ENTER TO WIN!

### 20th Anniversary Macintosh

250 MHz / 32MB RAM / 2GB HARD DRIVE / 12.1" FLAT PANEL DISPLAY / BOSE SOUND

## Holiday Sweepstakes

Name \_\_\_\_\_  
 Title \_\_\_\_\_  
 Company \_\_\_\_\_  
 Address \_\_\_\_\_  
 \_\_\_\_\_  
 \_\_\_\_\_  
 City \_\_\_\_\_ State \_\_\_\_\_ Zip \_\_\_\_\_  
 Phone \_\_\_\_\_ Fax \_\_\_\_\_  
 e-mail \_\_\_\_\_

#### Is this location:

Home  Business  Both

#### If Business:

Nature of business: \_\_\_\_\_

Education institution? Y \_\_\_\_\_ N \_\_\_\_\_

Number of employees at site: \_\_\_\_\_

Total number of employees: \_\_\_\_\_

#### What platform do you currently use?

PC  Mac  Both

#### Which of the following products do you plan to purchase in the next 6 months?

- CPU  
 If yes,  PC  Mac  Undecided  
 Monitor  Printer  
 Scanner  Networking products  
 Software

**SOURCE CODE**  
**MW801**

Ordering from The Mac Zone is Easy!

**CALL US TOLL-FREE!**

or **FAX** your order to 425.430.3500

**1-800-436-0606**

Circle 71 on your reader service card



# UP TO A \$250 INSTANT REBATE

## We Will Beat Any Computer Price!!!

### New Lower Prices!!!

### NEW Power Macintosh® G3 Series

**up to 166MHz**



**Apple® Macintosh® PowerBook® 1400cs**  
 133MHz PowerPC™ 603e/16MB RAM  
 1.3GB Hard Drive/8X CD-ROM  
 11.3" Dual Scan Display  
 Was \$2,499 **Now \$1,999!**  
 Order #22910

**Also available at MacMall**

**New!**



**up to 266MHz**

- 233MHz PowerPC™ G3
- 32MB RAM
- 4GB Hard Drive
- 24X CD-ROM

**\$1,999!** #24058  
 (Desktop Model)  
**Also Available at MacMall**  
 #24059 Power Macintosh G3/266MHz G3  
 32MB RAM/4GB Hard Drive/24X CD  
 Zip Drive/Desktop Model \$2,399  
 #24060 Power Macintosh G3/266MHz G3  
 32MB RAM/6GB Hard Drive/24X CD  
 Zip Drive/Mini-Tower (shown) \$2,999

- #22911 PowerBook 1400c/133MHz 603e/16MB RAM/1.3GB Hard Drive  
 8X CD-ROM/11.3" Active Matrix Display Was \$2,999 **Now \$2,699**
- #22912 PowerBook 1400c/166MHz 603e/16MB RAM/2GB Hard Drive  
 8X CD ROM/11.3" Active Matrix Display Was \$3,499 **Now \$2,999**

**Get 32MB RAM FREE or Quick Take Camera w/ any PowerBook 3400 purchase. Call your Sales Representative for details.**

### Special Offers on Power Mac's!

**Power Macintosh 4400**  
 200MHz PowerPC™ 603e/16MB/2GB HD/8X CD/2MB VRAM  
 Was \$1,499 **\$1,299!** #22887

- Also Available at MacMall**
- #22888 Power Macintosh 4400/200MHz 603e/32MB RAM  
 2GB Hard Drive/12X CD  
 33.6 modem/MS Office \$1,599
- #22899 Power Macintosh 7300/180MHz 604e  
 16MB RAM/2GB Hard Drive/12X CD \$1,999
- #22900 Power Macintosh 7300/200MHz 604e/32MB  
 RAM/2GB Hard Drive/12X CD \$2,199

**up to 300MHz**



**Save up to \$300 on a PowerMac 8600 and any Apple Display Purchase. Call your Sales Representative for details.**

- #22903 Power Macintosh 8600/250MHz 604e/32MB RAM/4GB Hard Drive/24X CD  
 Zip Drive(model shown above) \$2,599
- #22904 Power Macintosh 8600/300MHz/604e/32MB RAM/4GB HD/24X CD-ROM/Zip Drive \$3,099

Monitor sold separately on all models

**Save up to \$200 on a PowerMac 6500 and any Apple Display Purchase. Call your Sales Representative for details.**

**up to 300MHz**



**Power Macintosh 6500**

#22895 Power Macintosh 6500/250MHz/603e  
 32MB RAM/4GB HD/24X CD-ROM/56K modem \$1,999

#22896 Power Macintosh 6500/275MHz/603e  
 32MB/6GB HD/24X CD/56K modem/Zip Drive \$2,499

#22897 Power Macintosh 6500/275MHz/603e/48MB RAM  
 6GB HD/24X CD/56K modem/MSOffice/Zip Drive \$2,799

#22894 Power Macintosh 6500/300MHz 603e/64MB RAM  
 4GB HD/12X CD/33.6 Modem/Zip Drive \$2,499

Monitor sold separately on all models.

**MAC** **DJ700 17" Color Display**

- 16.1" viewable; JAG control
- 1280 x 1024 max. resolution @ 65Hz
- 26mm flat-square CRT

**\$499<sup>99</sup>** #89714 **Special! MacMall Price**

**PaperPort® vx** **visioneer**

- Scans paper in seconds
- Direct links to popular applications

**\$99<sup>99</sup>\*** #14609  
 \*After '50 mail-in rebate. Rebate expires 12/31/97.

**Memory**

**Starting as low as \$3<sup>12</sup> MB**



#65416 Prices subject to change. Please call for most current pricing.

**Macintosh PowerBook 3400c**  
 180MHz PowerPC™ /16MB RAM/1.3GB Hard Drive  
 12X CD-ROM/33.6 Modem  
 12.1" Active Matrix Display  
 Was \$3,999 **Now \$3,199!**  
 Order #22914

**up to 240MHz**



**Macintosh PowerBook 3400 Series**

#22915 PowerBook 3400c/200MHz/16MB/2GB HD  
 12X CD/33.6 Modem/12.1" Active Matrix Display Was \$4,499 **Now \$3,799**

#22916 PowerBook 3400c/240MHz/16MB/3GB HD  
 12X CD/33.6 Modem/12.1" Active Matrix Display Was \$5,499 **Now \$4,499**

**NEW Iomega® ZipPlus™ Drive!**

- 100MB SCSI/Parallel
- 28 X faster than a floppy drive
- 5 CD titles included

**\$199<sup>99</sup>** #14647



**Iomega® 1GB Jaz™ Drive External SCSI**

- FREE 1GB Cartridge w/ Jaz Tools included
- Up to 12ms access time

**\$289<sup>99</sup>** #15813  
 (Factory refurbished. Limit 5 per customer.)



**Fuji Zip Disks**  
**100MB Mac 10pk**  
**\$9<sup>99</sup>** per disk  
 after 20 mail-in rebate for 10-pk. 10 pack price before rebate is \$119\*  
 Ask for #88261



**D-220L Digital Zoom Camera**  
 ➤ 640 X 480 pixel resolution, 2MB

**New!** **\$499<sup>99</sup>** #14494  
**OLYMPUS**



**SOFTWARE EXCLUSIVE!**



**Only at MacMall... Mac OS 8 Upgrade & Speed Doubler 8 Plus—FREE RAM Doubler 2!**

**\$99<sup>99</sup>** only #11291  
 Price reflects \$30 mail-in upgrade rebate for users of Mac OS 7.6. Price before rebate is \$129

**Open 24 Hours**



**\$1.8 Billion Inventory Available!** **Over 45,000 Products!** **Custom Configuration!** **Fastest Overnight Delivery!**





# with any CPU purchase!

We'll beat any price from any authorized catalog reseller on any CPU we offer. Call us before you order from anyone else. We want your business!



**MOTOROLA**  
Authorized Computer Reseller

## Motorola StarMax 3000MT



200MHz PowerPC™  
603e/32MB RAM  
2.5GB Hard Drive  
8X CD-ROM  
Mini-tower  
(shown at left)

**\$849!**

#24009  
While supplies last.

#24012 StarMax 3000MT/200MHz/603e/32MB RAM  
4.3GB HD/8X CD/28.8 Modem/Mini-tower

'949



## New Low Prices! Motorola StarMax 5000MT

275MHz PowerPC™ 603e/32MB RAM/4.3GB Hard Drive  
16X CD-ROM/Zip Drive/Mini Tower model (shown above)

**\$2195!**

#22965

#24013 StarMax 5500MT/200MHz/604e/64MB RAM

'1599

#22966 StarMax 5000MT/300MHz/603e/32MB RAM

'2449

#22967 StarMax 5000MT/300MHz/603e/32MB RAM

'2849

All monitors on Motorola systems are sold separately

**UMAX**  
Computer Corporation

## UMAX C500/200LT

200MHz PowerPC™ 603e  
16MB RAM/2GB HD/8X CD

**\$995!**

#22926

(shown  
at right)

## Also Available UMAX C600 and S900

#22931 UMAX SuperMac C600/240MHz 603e/24MB RAM  
2.1GB Hard Drive/12X CD ROM

'1,395

#22917 UMAX SuperMac S900/200MHz 604e/32MB RAM  
2.1GB Hard Drive/8X CD ROM/4MB VRAM  
(shown at left)

'2,495

All monitors on UMAX systems are sold separately

**MacMall Exclusive  
Instant Rebates!**

Save up to  
an additional  
**\$250**

on Mac OS Systems and Powerbooks!  
No Mail-in Hassles!  
No Quantity Limits!  
Certain restrictions apply.  
Call for details.



**SuperMac  
C500**  
Up to 200MHz!  
for under \$1000!



**PowerComputing**

## Power Computing PowerBase 240MT

240MHz PowerPC™ 603e/ 16MB RAM  
2GB HD/16X CD ROM/2MB VRAM

**\$1,999!**

#22941 mini-tower (shown at left)



**While Supplies Last!**  
Call your Sales Representative  
for details.

Monitor sold separately.

**FREE!**

Marathon II Durandal  
w/any Software  
purchase from MacMall

Ask for #92532.  
2" shipping and handling fee.



## UMAX Astra 1200S Color Scanner

- 30-bit, single pass
- 600 x 1200dpi resolution
- Single-pass color CCD

was \$379 Now Only

**\$299**

#94333  
Includes Adobe PhotoDeluxe®, Presto! PageManager & Internet Software!

## Best Data 33.6K Data/Fax Modem

- 33.6K Data/14.4K Fax
- Create a customized voicemail system
- Free Data/Fax software

**\$48<sup>99</sup>**

#84415

\*After '20 mail-in rebate.



## Stylus Color Pro Printer

EPSON

Exclusive

- 720dpi print quality
- Optional PostScript & Network interface

**\$179<sup>99</sup>**

#96717 (factory refurbished)

#77043 Postscript Option for Stylus Pro

'69



## 56K Data/Fax Modem

- PnP installation
- Caller ID
- FREE Data/Fax software

**\$99<sup>99</sup>**

#95195

**NEW  
Low  
Price!**



## Adobe Illustrator 7.0 Upgrade

- New interface
- RGB color support
- Handles large images

**\$124<sup>99</sup>**

#94828



## Horton Utilities 3.5 CD

SYMANTEC

- OS 8 compatible
- Disaster recovery
- Ideal for large files and external drives

**\$59<sup>99</sup>**

Upgrade  
#15159



## Director 6 Upgrade CD

- 120 sprite channels
- Streaming Shockwave for Web multimedia
- Browser scripting
- Zooming & multiple views

**\$389<sup>99</sup>**

#91226



Order And Register to

**Win a NEW  
Mercedes SLK!**  
No purchase necessary.



Order Any Time! Open 24 Hours. Use Source Code #ZMWDB11

**1-800-217-9492**

Order Today by 11 pm EST—Get It Tomorrow by 10:30 am [www.macmall.com](http://www.macmall.com)

MacMall is not responsible for typographical errors or errors in content. Prices subject to change. Please call for most current pricing.

Circle 131 on reader service card

**MacMall**  
The Mall With It All... For Less!



# NEW PowerPC Blowouts



**Apple PowerBooks**  
AS LOW AS  
**\$2699!\***  
PowerBook 1400c/133MHz • CPU 0743  
While supplies last

**12X CD-ROM DRIVE!**

PowerBook 3400c/180MHz/  
16MB RAM/1.3GB Hard Drive/  
12x CD-ROM shown.

**PowerBook 3400c/180MHz**  
16MB RAM/1.3GB Hard Drive/33.6 modem/10Base-T Ethernet/12XCD  
CPU 0671 Was ~~\$3999~~ **Save \$800** Now **\$3199**

**PowerBook 3400c/200MHz**  
16MB RAM/2.0GB Hard Drive/33.6 modem/10Base-T Ethernet/12XCD  
CPU 0670 Was ~~\$4499~~ **Save \$700** Now **\$3799**

**PowerBook 3400c/240MHz**  
16MB RAM/3.0GB Hard Drive/33.6 modem/10Base-T Ethernet/12XCD  
CPU 0610 Was ~~\$5499~~ **Save \$1000** Now **\$4499**

**PowerBook 3400 Memory Upgrades**  
16MB CHP 0437 **\$249**  
32MB CHP 0439 **\$399<sup>95</sup>**

**THE SMALLEST, LIGHTEST, POWERBOOK EVER!**  
PowerBook 2400c/180MHz/16MB/1.3GB HDD/10.4" Active Matrix display  
CPU 0713 **\$3499**  
PowerBook 2400 Memory Upgrades  
16MB CHP 0474 **\$249**  
32MB CHP 0475 **\$399**

**PowerBook 1400c/133MHz/16MB RAM/1.3GB HD/8X CD/L2/11.3" Active Matrix Display**  
CPU 0743 Was ~~\$3999~~ **Save \$500** Now **\$2699**

**PowerBook 1400c/166MHz/16MB RAM/2.0GB HD/8X CD/L2/11.3" Active Matrix Display**  
CPU 0745 Was ~~\$3499~~ **Save \$300** Now **\$2999**

**PowerBook 1400 Memory Upgrades**  
16MB CHP 0410 **\$229**  
24MB CHP 0411 **\$329**  
32MB CHP 0498 **\$359**

\*While supplies last.

## PowerBook 3400:

- 180, 200 or 240MHz PowerPC 603e processor
- 16MB of RAM (expandable to 144MB)
- Internal 1.3, 2, or 3GB hard disk drive
- Internal 12X CD-ROM
- 256K Level-2 cache

**11.3" Active Matrix Color SVGA Display**



**8X CD-ROM DRIVE!**

PowerBook 1400c/133 16MB RAM  
with 8X CD-ROM drive shown.

## Huge Savings on Apple Power Macs

Prices slashed up to \$800!

- 250-300MHz PowerPC 604e processor
- 32MB-64MB RAM, expandable up to 768MB
- 4.0GB hard drive
- Omega 100MB Zip drive
- 24X CD-ROM drive
- 2MB-8MB VRAM
- 1MB Level-2 Cache
- Built-in 10Base-T and AAUI ethernet connections

GET UP TO A **\$300 REBATE!**  
WITH PURCHASE OF APPLE MONITOR!



**300MHz**

Monitor sold separately.

**Power Macintosh 8600/250MHz**  
32MB/4GB/24XCD/Omega Zip Drive  
CPU 0850 Was ~~\$3199~~ **\$2599**

**Power Macintosh 8600/300MHz**  
32MB/4GB/24XCD/Omega Zip Drive  
CPU 0784 Was ~~\$3699~~ **\$3099**

**Power Macintosh 9600/300MHz**  
64MB/4GB/24XCD/Omega Zip Drive  
CPU 0785 Was ~~\$4599~~ **\$3799**

† Price for Power Mac 8600 when purchased with any Apple monitor (excluding refurbished Apple monitors). Price reflects Apple mail-in rebate. See individual items for rebate amounts. Allow 6-8 weeks for delivery. Good for purchases between 10/31/97 and 1/16/98. Power Mac 8600 and Apple monitor may appear on same invoice. Ask for coupon #AAA0596.

## Power Mac 7300

- PowerPC 604e processor
- 16 or 32MB of RAM, expandable to 512MB
- 2GB fast SCSI Internal HD
- Internal 12X CD-ROM
- Built-in 10 Base-T and AAUI Ethernet connections
- 2MB VRAM

Monitor sold separately.

**Power Macintosh 7300/180MHz**  
16MB/2GB/12XCD CPU 0571 Was ~~\$2299~~ **\$1999**

**Power Macintosh 7300/200MHz**  
32MB/2GB/12XCD CPU 0572 Was ~~\$2699~~ **\$2199**

**Power Macintosh 7300/180MHz PC Compatible**  
180MHz Power PC 604e processor w/32MB RAM and 166MHz Pentium Processor with 32MB RAM/2GB HD/12XCD  
CPU 0676 **\$2999**

**Memory Upgrades for Power MAC 7300/8600/9600**  
16MB CHP 0383 **\$179<sup>95</sup>**  
32MB CHP 0382 **\$249<sup>95</sup>**  
64MB CHP 0392 **\$599**

## ORDER ONLINE! and Get FREE Software!

[www.warehouse.com](http://www.warehouse.com)

**3 Ways to Order:**  
1. Phone: 1-800-434-3036  
2. FAX: 1-732-942-2502  
3. Online: [www.warehouse.com](http://www.warehouse.com)

**30 DAY Money Back GUARANTEE**

- Our sales staff is ready to take your order 24 hours a day, 7 days a week.
- We accept the following major credit cards: Visa, MasterCard, Discover Card/NOVUS, AmEx. Your credit card will not be charged until each item is shipped (no surcharge).
- CT, IL, NJ, and OH residents add applicable sales tax.
- Overnight delivery just \$3.95 per order up to 3 pounds. For all orders over 3 pounds, shipping is \$1.25 per pound or fraction thereof. (Example: for a 4 pound

order is \$5.00). Please add an additional handling charge of \$3.00 for all orders under \$50.00.

- Place your order for "in-stock" items up to 12:00 midnight (E) (weekdays), and we will ship same day for overnight delivery (barring system failure, etc.).
- Many of our products come with a 30-Day Money Back Guarantee. All items we sell come with the MacWAREHOUSE 30-Day Guarantee Against Defects.

**30-DAY Guarantee Against Defects**

© Copyright 1997 Micro Warehouse, Inc. MacWAREHOUSE® is a division of Micro Warehouse, Inc. MacWAREHOUSE® and MicroWAREHOUSE® are registered trademarks and Data Comm Warehouse, Inc. Apple, the Apple logo, Mac and Macintosh are registered trademarks of Apple Computer, Inc. Item availability and price subject to change without notice. We regret that we cannot be responsible for typographical errors. All prices shown in U.S. dollars.

Choose one of these software packages when you place an online order with MacWAREHOUSE!  
\*Limit one per customer  
\$2.95 shipping & handling.  
Shipped in promotional packaging.  
While supplies last.

**WHILE SUPPLIES LAST**

**SUPER FAST CD-ROM DRIVES**  
Plus, get F/A 18 Hornet 3.0 FREE! when you buy an 8X or 24X CD-ROM Drive!

For FREE F/A 18 Hornet. Ask for item #AAA 0520

24X CD-ROM Drive-Item # DRI 2302 **\$189.95**  
12X CD-ROM Drive-Item # BND 2345 **\$149.95**

as low as **\$149<sup>95</sup>**

**ZIP DRIVES**

only **\$139<sup>95</sup>** Item # DRI 1050

100MB Zip Disks	1-9	10-19	20+
Ask for MED 0165	\$19.95ea	\$16.95ea	\$12.99ea

\*Reformatted by the manufacturer to meet original factory specifications

**LOWEST MEMORY PRICES EVER!**

as low as **\$19<sup>95</sup>**

1MB SIMMS Item # CHP 0022

**HP LASERJET 4000**

**New!** only **\$1499<sup>95</sup>** Item # PR12975

- 17ppm engine and 100MHz RISC processor
- HP FaxRes 1200 and HP PrintRes 1200
- Genuine Adobe PostScript Level 2 Software
- 8MB memory expandable



# from MacWAREHOUSE!

**UMAX G500LT/200**

- ★ 200MHz PowerPC 603e Processor
- ★ 16MB RAM
- ★ 2.0GB Internal Hard Drive
- ★ 8X CD-ROM Drive
- ★ 1MB VRAM
- ★ Two PCI Expansion Slots
- ★ Extended Keyboard & Mouse

**\$999!**

Monitor sold separately. Ask for Item # CPU 0836

**PERFORMA 6400/200 VIDEO EDITING EDITION**

- ★ 200MHz PowerPC 603e Processor
- ★ 32MB RAM
- ★ 2.4GB hard drive
- ★ 8X CD-ROM
- ★ 28.8Kbps fax modem
- ★ 1MB VRAM
- ★ Two fast PCI expansion slots
- ★ Avid Cinema Card! Create professional-looking movies right from your Mac!

**\$1599**

Monitor sold separately. Item # CPU 0552

Comes loaded with home, education, and home-business programs... PLUS a full collection of multimedia CDs!

**MacWAREHOUSE EXCLUSIVE!**

**PowerBase Low Profile 240MHz**

- ★ 240MHz PowerPC™ 603e processor!
- ★ 16MB RAM (expandable to 160MB)!
- ★ 2.0GB hard drive!
- ★ 16X CD-ROM drive!
- ★ 2MB VRAM graphics on board!
- ★ ADB keyboard and mouse!
- ★ Three fast PCI expansion slots!

**PowerBase Low Profile 240MHz**  
256K cache/16X CD-ROM  
Item # CPU0882..... **\$999\***  
**Power Computing 15" Multi Media Display Monitor**  
BND 2337..... **\$349.95**

as low as  
**\$999!\***  
CPU0882  
While Supplies Last!



\*Price for PowerBase 240 Low Profile when purchased with a Power Computing 15" monitor. Price reflects \$100 MacWAREHOUSE mail-in rebate. Price for PowerBase 240 before rebate is \$1099. Price for Power Computing 15" Multi Media Display monitor is \$349.95. PowerBase 240 Low Profile and Power Computing 15" Multi Media Display monitor must appear on same invoice. Offer expires 11/30/97 or while supplies last.

**NEW VERSION! NETSCAPE COMMUNICATOR 4.0 INTERNET ACCESS EDITION**

Everything you need to communicate on the Internet!

Upgrade for only **\$29.95!\***

Includes Netscape Navigator 4.0!

30 Days FREE Internet Access and Details Inside Box

Ask for item # COM 0837 (CD-ROM)

\*Price reflects publishers \$30 mail-in upgrade rebate for previous owners. Price before rebate is \$59.95. See coupon inside packaging for details. \*See details inside box for selected Internet service providers.

**UPGRADE TO MAC™ OS 8.0**

Only **\$69.95!\***

Get 5 CDs FREE!

Ask for item # UPG 0687 (CD-ROM)

Mac OS 8.0 requires 68040 or PowerPC based machine.

When you buy Mac OS 8.0 now. Ask for AA4054B. 5 FREE CDs include Ethernet Internet Access, Marathon, 3000 Mega DigArt Pack & more... \*\$2.95 shipping & handling applies. Shipped in promotional packaging. \*Qualifying products Mac OS 7.5 purchased or acquired through CPU purchase.

**HURRY! WHILE SUPPLIES LAST!**

**NEW VERSION! UPGRADE TO FILEMAKER PRO 4.0**

Create your own Relational Databases!

Only **\$99.95!\***

Ask for item # UPG 0722

\*Packaging may vary. Proof of ownership required.

**MacWAREHOUSE**

To order, call toll-free 24 hours a day, 7 days a week **1-800-434-3036**

Your #1 Source for Apple Products!

FREE CATALOG SUBSCRIPTION! Check the appropriate box(es) to receive your FREE 1-year catalog subscription(s) and mail this coupon to: 1720 Oak Street, P.O. Box 3013, Lakewood, NJ 08701

Name \_\_\_\_\_

Address \_\_\_\_\_ E-Mail \_\_\_\_\_

City \_\_\_\_\_ State \_\_\_\_\_ Zip \_\_\_\_\_

(Expect to receive your first issue(s) within 4-6 weeks.)

Yes, send me my FREE Power User's Tool Kit. Enclosed is my check for \$2.95 to cover shipping & handling.

MacWAREHOUSE  MicroWAREHOUSE  DataComm WAREHOUSE  MicroSystems WAREHOUSE

**For your FREE Canadian Catalog, call toll-free 1-800-603-5139!**



Circle 150 on reader service card



# MEGAHAUS OUR DRIVE PRICES CAN'T BE BEAT!

## • UNBEATABLE DEALS •

### IOMEGA JAZ DRIVE

Full retail package in Iomega case.  
1GB External w/1 disk [JAZX] \$374  
1GB Media any qty [JAZC1G1GMAC] \$82  
2GB External w/1 disk [JAZ2X] \$639  
2GB Media any qty [JAZC2G1GMAC] \$148

### SYQUEST SJAZZ DRIVE

Drive in our case. Ask about mail-in offer.  
External w/1 disk [SYJET15MEX] \$345  
Media any qty [SJ1.5C] \$84

### PCI WIDE CONTROLLERS

Adaptec Single [A2940MUW] \$269  
Dual Channel [A3940MUW] \$529

### 4.6GB OPTICAL DRIVE

Ext w/1 disk [SS4.6MAC] \$1199

### CDR74 BLANK MEDIA

5 PACK [CDR74-5] \$17  
20 PACK [CDR74-20] \$47  
50 PACK [CDR74-50] \$99  
100 PACK [CDR74-100] \$179  
Add 90¢ per disk for printable media.  
We will not be undersold on CD  
Recordable or CD ReWritable media!

### QUANTUM IDE DRIVES

3.2GB [FB33240AJ] \$200  
4.3GB [FB34320AJ] \$249  
6.4GB [FB36480AJ] \$327

### HITACHI 2.5" IDE DRIVES

2.1GB [DK225A21] \$240  
3.2GB [DK226A32] \$390  
4.0GB [DK227A41] \$call

We custom configure  
to your needs:

### RAID

### A/V

Call us

Super cooling drive fan. \$30 Alone  
or added to an external hard drive.



Hot Swappable drive kits. Available  
alone or added to an external unit.

## • SCSI HARD DRIVES •

### MICROPOLIS We will beat any advertised Micropolis price!

Capacity	Rotational	Seek	Model	Int	Ext
4300MB	10ms	5400rpm	512K MC4743	\$325	\$375
4550MB	7.9ms	7200rpm	512K MC4345	\$490	\$550
9091MB	8.5ms	7200rpm	512K MC3391	\$850	\$910

ULTRA SCSI A/V - Drives fine tuned for audio and video applications. 2MB Buffer!

4550MB	7.9ms	7200rpm	2MB MC4345AV	\$550	\$610
9091MB	8.5ms	7200rpm	2MB MC3391AV	\$890	\$950

### ULTRA WIDE SCSI

4300MB	10ms	5400rpm	512K MC4743W	\$330	\$410
4550MB	7.9ms	7200rpm	512K MC4345W	\$510	\$590
9091MB	8.5ms	7200rpm	512K MC3391W	\$870	\$950

ULTRA WIDE SCSI A/V - Drives fine tuned for audio and video applications. 2MB Buffer!

4550MB	7.9ms	7200rpm	2MB MC4345WAV	\$570	\$650
9091MB	8.5ms	7200rpm	2MB MC3391WAV	\$920	\$990

### Seagate

We will beat any advertised Seagate price!

2150MB	11ms	5400rpm	128K ST52160N	3yr \$225	\$275
2160MB	8ms	7200rpm	1024K ST32272N	5yr \$345	\$395
4550MB	9.1ms	7200rpm	512K ST34555N	3yr \$359	\$409
4550MB	8ms	7200rpm	512K ST34572N	5yr \$525	\$575
4550MB	7.5ms	10,000rpm	512K ST34501N	5yr \$609	\$659
9100MB	8ms	7200rpm	512K ST19171N	5yr \$869	\$919
9100MB	8ms	10,000rpm	512K ST19101N	5yr \$999	\$1049
23200MB	13ms	5400rpm	512K ST423451N	5yr \$1669	\$1769

### WIDE SCSI

2160MB	8ms	7200rpm	512K ST32272W	5yr \$375	\$465
4550MB	8ms	7200rpm	512K ST34572W	5yr \$549	\$639
4550MB	7.5ms	10,000rpm	512K ST34501W	5yr \$635	\$725
9100MB	8ms	7200rpm	1024K ST19171W	5yr \$889	\$979
9100MB	8ms	10,000rpm	512K ST19101W	5yr \$1025	\$1115
23200MB	13ms	5400rpm	512K ST423451W	5yr \$1689	\$1839

### Quantum We will beat any advertised Quantum price!

2151MB	10ms	5400rpm	128K FB32160S	3yr \$225	\$275
2275MB	8ms	7200rpm	512K VK32275S	5yr \$335	\$385
3228MB	10ms	5400rpm	128K FB33240S	3yr \$275	\$325
4310MB	10ms	5400rpm	128K FB34320S	3yr \$309	\$359
4550MB	8ms	7200rpm	512K VK34550S	5yr \$465	\$515
4550MB	8ms	7200rpm	512K XP34550S	5yr \$519	\$569
6448MB	10ms	5400rpm	128K FB36480S	3yr \$405	\$455
9100MB	8ms	7200rpm	512K XP39100S	5yr \$819	\$859

### ULTRA WIDE SCSI

2275MB	8ms	7200rpm	512K VK32275W	5yr \$335	\$425
4550MB	8ms	7200rpm	512K VK34550W	5yr \$465	\$555
4550MB	8ms	7200rpm	512K XP34550W	5yr \$519	\$609
9100MB	8ms	7200rpm	512K XP39100W	5yr \$819	\$909

### FUJITSU

4400MB	8ms	7200rpm	512K M2954S	5yr \$539	\$589
9100MB	8ms	7200rpm	512K M2949S	5yr \$899	\$949

### WIDE SCSI

4400MB	8ms	7200rpm	512K M2954W	5yr \$555	\$645
9100MB	8ms	7200rpm	512K M2949W	5yr \$965	\$1055

We stock a complete line of IDE drives including Toshiba 2.5" IDE Hard Drives!

## • CD RECORDERS •

Smart Storage Solutions CDR Drives Include  
5 FREE disks and Toll Free support!

Duo Master systems include 1 Free cartridge!

### 2x6 CD Recorder

- 2x record, 6x playback
- High quality Sony mechanism.
- Caddy loading
- Includes 5 FREE blank CDs.
- Includes #1 rated Adaptec Toast software.

Complete external only \$375

Duo Master with Jaz or SyJet Drive \$690 CD-R media only \$2.25ea w/ drive!



### 4x6 CD Recorder

- 4x record, 6x playback
- High quality Yamaha mechanism.
- Choose tray or caddy loading
- Includes 5 FREE blank CDs.
- Includes #1 rated Adaptec Toast software.

Complete external only \$489

Duo Master with Jaz or SyJet Drive \$805 CD-R media only \$2.25ea w/ drive!



### 2x6 CD ReWritable

- 2x record, 6x playback
- High quality Ricoh mechanism.
- Writes to CD-R or CD-RW media.
- Loading: Tray 1MB, Caddy 2MB.
- Includes 5 FREE rewritable CDs.
- Includes #1 rated Adaptec Toast software.

Complete 1MB external \$549

Duo Master with Jaz or SyJet Drive \$865

Complete 2MB external \$579

Duo Master with Jaz or SyJet Drive \$895

CD-R media only \$2.25ea w/ drive!

CD-RW media only \$18.25ea w/ drive!



### 4x12 CD Recorder

- 4x record, 12x playback
- High quality Teac mechanism.
- Tray loading. 1MB buffer
- Includes 5 FREE blank CDs.
- Includes #1 rated Adaptec Toast software.

Complete external only \$569

Duo Master with Jaz or SyJet Drive \$885

CD-R media only  
\$2.25ea w/ drive!



Signature  
CD COLOR PRINTER  
Printable media only  
\$2.95ea w/ printer!

- Better than ink markers and paper stick on labels.
  - Conveys a more professional image.
  - Highly water resistant. Easy to apply.
  - No more ruined or out of balance CD's.
  - Compatible with MacOS, Windows 3.1, 95, and NT.
- \$1069 (CDPRINTER)

## • CD ROM DRIVES • External

NEC 16X	100ms	256K	Tray	\$169 [CDR1610XM]
Nakamichi 16X	130ms	5 Disk Changer		\$289 [MJS16XM]
Plextor 20X	95ms	512K	Tray	\$275 [PX20TSM]
NEC 24X	85ms	128K	Tray	\$199 [CDR1810XM]
Pioneer 24X	90ms	6 Disk Changer		\$439 [DRM6324XM]
Teac 32X	85ms	128K	Tray	\$199 [CD5325XM]

## • SCSI TAPE BACKUP •

These tape drives include backup software and 1 FREE TAPE!

### EXABYTE

7-14GB, 8mm, DAT, 60MB/min	\$729 [EXB8700LTXM]
7-14GB, 8mm, DAT, 120MB/min	\$1549 [ELJANTXMX]

### SONY

4-8GB, 4mm, DDS-2 DAT, 44MB/min	\$759 [SDT5000XM]
4-8GB Pro, 4mm, DDS-2 DAT, 90MB/min	\$829 [SDT7000XM]
12-24GB, 4mm, DDS-3 DAT, 144MB/min	\$1109 [SDT9000XM]
32-64GB, 4mm, DDS-2 DAT, 8 tape loader. 90MB/min	\$1949 [TSL7000XM]

We sell all brands of - hard drives, tape drives, optical drives, CD duplicators, CD recorders, CD mastering software, CD towers, CD ROM, RAID adapters and software, controllers, enclosures, mounting brackets, PCMCIA adapters and drives, laptop hard drives, & much more. See our web site or call with your requirements.

Since  
The Drive Authority  
1987

# MEGAHAUS



# 1-800-786-1184

Sales lines open: M-F 8-8 Sat 9-3 CST

2201 Pine Drive, Dickinson, Texas 77539  
(281)534-3919 FAX (281)534-6580

http://www.megahaus.com

\*Price beating policy is for this magazine issue only, and retail drive only. Competitor must have drive in stock and must be a new drive with full warranty. Price beating policy is limited to 1 day per customer. Prices & specifications subject to change without notice. Shipping charges are non-refundable. Returns must be in new condition and original packaging. Defective items may not be returnable. No refunds on software or special orders (items not listed in ad). All refunds subject to 15% restocking fee. All trademarks are registered trademarks of their respective companies. Personal needs and preferences are. We reserve the right to modify any sale for any reason. Bundle price good only if sold as listed. ©1997 MegaHaus Inc.



# LEASE FROM Digital Graphix

**\$0 Down 100% Business Financing NO Payments for 90days!**

**9600/350**  
DTP Hi-End SOLUTION

9600/350 starting at \$4799!

- PowerPC 9600/350 w/ 24xCD
- 320MB RAM, 4GB HD, 1MB Cache
- Internal Zip, Apple keyboard
- Viewsonic 21" P810 monitor
- IMS 8MB PCI video card
- Microtek ScanMaker III/Trans/Photoshop
- GCC 808 800dpi 11x17 Printer & Enet
- SyJet 1.3GB Drive with 1 cartridge
- Wacom 12x12 Graphics Tablet
- Sony SDT-2500 DAT Tape Backup

**FREE!** \$200 MODEM

**ZERO DOWN!**  
**\$359** PER MONTH

**\$12 A DAY!!**

**FREE!**

**Go Custom**

7300/200 starting at \$1499!

- PowerPC 7300/200 w/ 12xCD
- 96MB RAM, 2GB HD
- Apple keyboard
- IOmega Zip 100 w/ 1 cart
- Viewsonic 17EA AV monitor
- Scanmaker V300 color scanner
- 4MB Video RAM
- Apple LaserWriter 4/600, 600 dpi printer w/ 2 AppleTalk connectors
- Wacom 6x8 Artz Graphics Tablet

**ZERO DOWN!**  
**\$109** PER MONTH

**\$4 A DAY!!**

**FREE!**

**8600/300**  
MIDRANGE DTP STATION

8600/300 starting at \$2399!

- PowerPC 8600/300 w/ 24xCD
- 160MB RAM, 4GB HD, 1MB Cache
- Apple keyboard
- Int IOmega Zip 100 w/ 1 cart
- Viewsonic 17EA AV monitor
- Scanmaker v300 color scanner
- ATI 4MB PCI video card
- GCC608 11x17, 600 dpi printer w/ Ethernet connectors
- Wacom 12x12 Graphics Tablet

**ZERO DOWN!**  
**\$199** PER MONTH

**\$6 A DAY!!**

**FREE!**

**9600/300**  
REAL TIME VIDEO CAPTURE SYSTEM

9600/300 starting at \$2799!

**60 Frames/Sec**

- PowerPC 9600/300MHz w/ 24xCD
- 448MB RAM, 4GB HD
- 1MB Cache
- Extended keyboard
- Internal Zip 100 w/ 1 cart
- Sony 20" Trinitron monitor
- IMS 8MB PCI video card
- TrueVision Targa Pro 1000
- Internal 18GB FW Disk Array with Adaptec SCSI Controller/Remis SW
- Yamaha 4x/6x CDR/10 carts/Toast SW

**ZERO DOWN!**  
**\$329** PER MONTH

**\$10 A DAY!!**

**FREE!**

**8600/250**  
3-D VIDEO/AUDIO WORKSTATION

8600/250 starting at \$2079!

- PowerPC 8600/300 w/ 24xCD
- 416MB RAM, 4GB HD, 1MB Cache
- Extended keyboard, Int. Zip Drive
- Radius 801HR 1600x1200 Monitor
- Radius Thunder 3-D PCI Video
- ScanMaker V300 color scanner
- Strata Studio Pro V2.0 3D Software
- GCC608 11x17, 600 dpi printer w/ Ethernet connectors

**ZERO DOWN!**  
**\$279** PER MONTH

**\$9 A DAY!!**

**FREE!**

### Lease System Specials

System Description	Price	Lease
Apple PowerBook 1400CS 133/16MB/1.3GB/8x/CD	\$1499	\$53.65
Apple PowerBook 1400C 133/16MB/1.3GB/6x/CD	\$1999	\$70.59
Apple PowerBook 3400C 200/16MB/2GB/12x/CD	\$2899	\$96.02
Apple PowerMac 6500 250/48MB/4GB/12x/CD/Zip/Mod	<b>\$1439</b>	<b>\$50.82</b>
Apple PowerMac 6500 300/64MB/4GB/12x/CD/Zip	\$1759	\$61.98
Apple PowerMac 7300 180/32MB/2GB/12x/CD	\$1439	\$50.82
Apple PowerMac 7300 200/32MB/2GB/12x/CD	\$1499	\$53.65
Apple PowerMac 8600 200/32MB/2GB/12x/CD/Zip	\$1899	\$67.77
Apple PowerMac 8600 250/32MB/4GB/24x/CD/Zip	\$2079	\$73.42
Apple PowerMac 8600 300/32MB/4GB/24x/CD/Zip	\$2399	\$84.04
Apple PowerMac 9600 200/32MB/2GB/12x/CD/MS 4MB	<b>\$2199</b>	<b>\$76.25</b>
Apple PowerMac 9600 300/64MB/4GB/24x/CD/Zip/IMS 8MB	\$2799	\$98.85
SuperMac S900L 250/32MB/4GB/16x/CD/IMS 8MB/Zip	\$2079	\$73.42
PowerTower Pro 250/128MB/8GB/16x/CD/IMS 8MB	\$1759	\$61.98

**Hurry Sale Only a Few Left at these Prices!!**

### Memory

**64 MB Only \$219**

**256K Cache Only \$29**

Size	DIMMS	SIMMS
4MB	N/A	\$19
8MB	\$34	\$29
16MB	\$59	\$57
32MB	\$109	\$109
<b>64MB</b>	<b>\$219</b>	NA
128MB	\$679	NA

**Lifetime Warranty**

**IOmega JAZ 1GB Ext \$299!**

**JAZ 1GB Carts \$79**



### Monitors

Sony 100SX 15", 1280x1024, .25mm	\$326
ViewSonic 15 E655, 1024x768, .28mm	\$278
ViewSonic EA 771AV, 1280x1024, .28mm	<b>\$529</b>
ViewSonic 17GA, 1152x870, .27mm	\$578
Sony 200SX 17", 1024x768, .25mm	\$603
Sony 200SF 17", 1280x1024, .25mm	\$699
Sony 205F IIT-300, 1600x1200, .30mm	\$1379
ViewSonic GT800 20", 1600x1280, .30mm	\$1069
ViewSonic P810 21", 1600x1200, .25mm	<b>\$1279</b>
ViewSonic P815 21", 1600x1200, .25mm	<b>\$1419</b>
RasterOps MC803 21", 1800x1440, .22mm	\$1799
RasterOps MC801 21", 1600x1200, .22mm	\$1549
Radius PressView 21SR, 1600x1200, .25mm	\$3189

### SyQuest & ZIP Drives

ZIP 100 External	<b>\$129</b>
SyJet 1.5GB External	\$299
SyQuest 200MB External	\$379

### Optical & CDR Drives

IOmega Jaz 1GB Ext./DG Jaz 1GB Ext	<b>\$299/269</b>
Jaz 1GB & 2x/6x CDR Combo Drive	\$799
Ricoh 2x/2x/6x Rewrite CDR with Toast/cart	\$599
Sony 2x/6x CDR with Toast/cart	\$449
Yamaha 4x/6x CDR with Toast/cart	\$599

### Hard Drives

Description (at SCSI-3 Ultra)	Internal	External
Quantum 2.1GB 5400 rpm Stratus 9ms	\$219	\$279
Quantum 2.2GB 7200 rpm Viking 7.9ms	\$379	\$439
Quantum 3.2GB 5400 rpm Stratus 9ms	\$319	\$379
Quantum 4.3GB 5400 rpm Stratus 9ms	<b>\$339</b>	<b>\$399</b>
Quantum 4.5GB 7200 rpm Viking 7.9ms	\$499	\$559
Quantum 9.1GB 7200 rpm Atlas II 7.9ms	\$899	\$949
Fujitsu 9.1GB 7200 Ultra SCSI 7.9ms	<b>\$879</b>	<b>\$999</b>
Seagate 4.5GB 7200 rpm Barracuda 4 7.9ms	\$719	\$779
Seagate 9GB 7200 rpm Barracuda 9 7.9ms	\$1089	\$1149
Seagate 4.5GB 10000 rpm Cheetah 7.9ms	<b>\$769</b>	<b>\$829</b>
Seagate 9.1GB 10000 rpm Cheetah 7.9ms	<b>\$1259</b>	<b>\$1319</b>

### Removable Cartridges

<b>JAZ 1GB</b>	<b>\$79</b>
Zip 100MB	\$12
Syjet 1.5	\$82
200MB	\$55
88MB	\$35
44MB	\$33

**JAZ 1GB Only \$79**

### Optical Cartridges

<b>74 MINUTE CD ROM RECORDABLE MEDIA</b>	<b>\$24.99</b> BOX OF 10
3EM 128MB	\$6.79
OEM 230MB	\$8.99
OEM 600/650MB	\$24.99
OEM 1.2/1.3GB	\$36.99

### Tape Drives

Sony 4GB - 5200	\$769
Sony 8GB - 7000	<b>\$899</b>
Sony 8GB - 5000	<b>\$799</b>
Sony 24GB - 9000	<b>\$1099</b>
Sony AIT 50GB	\$3295

### Scanners

LinoColor Jade Scanner 33bit	\$479
Agfa SnapScan/Color It	\$289
Agfa Arcus II/Transparency/Photoshop	\$1539
Agfa DuoScan/Transparency/Photoshop	\$3999
Epson Expression 636 Professional/Photoshop	\$1379
Microtek Scanmaker III/Trans/Photoshop	<b>\$1379</b>
Microtek Scanmaker V300/Color It	\$149
Microtek E6 Pro/ Full Photoshop	\$519

### Laser Printers

Epson Stylus Color 3000, 17x22, Serial, Ink, 1440dpi	<b>\$1739</b>
Epson Stylus Color 800, 8.5x11, Serial, Ink, 1440dpi	\$389
GCC EL 1212, 1200dpi, 8.5x11, Enet, 12ppm	<b>\$1429</b>
GCC XL 608, 600dpi, 11x17, Ethernet, 8ppm	\$2289
GCC XL 616, 600dpi, 11x17, Ethernet, 16ppm	\$2389
GCC XL 808, 800dpi, 11x17, Ethernet, 8ppm	\$2949
GCC XL 1208, 1200dpi, 11x17, Ethernet, 8ppm	\$3989
HP870CX1, 600dpi, 8.5x11, AppleTalk, Inkjet	\$374





**COMPUTER  
DISCOUNT  
WAREHOUSE**

**The right price.  
The right advice.**

**We're more**

**Call CDW**

today and get some honest, friendly, professional advice that will save you more than money.



**Apple® Power Macintosh® 8600/250**

- 250MHz PowerPC™ 604e processor
- 32MB RAM standard, expandable to 512MB
- 4GB Fast SCSI hard drive
- 24X CD-ROM drive

**Integrated iomega Zip drive!**

**\$2599.00**

Monitor sold separately  
CDW 95335



**Apple® Power Macintosh® G3 Series**

- 233MHz or 266MHz PowerPC™ G3 processor
- 66MHz system bus speed ■ 32MB RAM standard ■ 4GB or 6GB IDE hard drive ■ 24X Max CD-ROM drive
- iomega Zip drive (on select models)

**NEW!**



**As low as!**  
**\$1999.00**

Monitor sold separately  
CDW 99851

**HARDWARE, SOFTWARE & PERIPHERALS AT DISCOUNT PRICES!**

**COMPUTERS**

Apple® Power Macintosh® Series	
6500 225MHz PowerPC 603e	1599.00
32MB 3GB 12X CD	
6500 250MHz PowerPC 32MB	
4GB 24X CD	1999.00
6500 275MHz PowerPC 603e 32MB	
4GB 12X CD	2499.00
6500 275MHz PowerPC 32MB	
6GB 24X CD iomega Zip drive	2499.00
6500 275MHz PowerPC 48MB	
9GB 24X CD iomega Zip drive	2799.00
6500 300MHz PowerPC 603e 64MB	
4GB 12X CD	2499.00
6500 300MHz PowerPC 64MB	
6GB 24X CD iomega Zip drive	2999.00
7300 200MHz PowerPC 604e 32MB	
2GB 12X CD	2199.00
7300 PC compatible 180MHz PowerPC	
604e/166MHz Intel Pentium processor	3199.00
7350 Application Server Solution 180MHz	
PowerPC 604e 48MB 4GB 12X CD	2499.25
7350 Internet Server Solution 160MHz	
PowerPC 604e 48MB 4GB 12X CD	3079.36
7350 AppleShare Server Solution 180MHz	
PowerPC 604e 48MB 4GB 12X CD	3266.34
8600 250MHz PowerPC 604e 32MB	
4GB 24X CD Zip drive	2599.00
8600 300MHz PowerPC 604e 32MB	
4GB 24X CD Zip drive	3099.00
9600 300MHz PowerPC 604e 64MB	
4GB 24X CD iomega Zip drive	3799.00
9650 Application Server Solution 350MHz	
PowerPC 604e 64MB 2x4GB 24X CD	5389.99
9650 Internet Server Solution 350MHz	
PowerPC 604e 64MB 2x4GB 24X CD	5885.67
9650 AppleShare Server Solution 350MHz	
PowerPC 604e 64MB 2x4GB 24X CD	5999.70
Apple® Macintosh® PowerBook® Series	
1400c 133MHz PowerPC 603e 16MB	
1.3GB 11.3" active 8X CD	2699.00
1400c 166MHz PowerPC 603e 16MB	
2GB 11.3" active 8X CD	2999.00
2400 180MHz PowerPC 603e 16MB	
1.3GB 10.4" active	3499.00
3400c 180MHz PowerPC 603e 16MB	
1.3GB 12.1" active 12X CD	3199.00
3400c 200MHz PowerPC 603e 16MB	
2GB 12.1" active 12X CD	3799.00
3400c 240MHz PowerPC 603e 16MB	
3GB 12.1" active 12X CD	4499.00

**UMAX**

SuperMac Series Desktops	
C500LT 200MHz PowerPC 603e	
16MB 2GB 8X CD	995.00
C500e 200MHz PowerPC 603e	
16MB 2GB 12X CD 10BT	1095.00
C500i 200MHz PowerPC 603e	
16MB 2GB 12X CD	1095.00
J700 180MHz PowerPC 604e	
24MB 2 1GB 8X CD	1795.00
SuperMac Series Mini-towers	
C600 200MHz PowerPC 603e	
16MB 2 1GB 8X CD	1195.00
CP00LT 240MHz PowerPC 603e	
24MB 2GB 12X CD 10BT	1395.00
C600x 240MHz PowerPC 603e	
32MB 3GB 12X CD 10BT	1795.00
C600x 280MHz PowerPC 603e	
32MB 4GB 12X CD 10BT	2095.00
SuperMac Series Mini-towers	
S900 200MHz PowerPC 604e	
32MB 2 1GB 8X CD 10BT	2495.00
S900 233MHz PowerPC 604e	
32MB 2 1GB 8X CD 10BT	2895.00
S900L 250MHz PowerPC 604e	
32MB 2 1GB 8X E100	3495.00
S900DP 2x250MHz PowerPC 604e	
64MB 4GB 12X E100	6995.00

**HANDHELD COMPUTERS**

eMate 300	799.00
MessagePad 2000	965.83
MessagePad 2000 w/keyboard & case	1047.49

**MONITORS**

MultipleScan 15AV 15" 0.28mm	388.46
MultipleScan 720 17" 0.28mm	649.00
AppleVision 750 17" 0.25mm	849.00
AppleVision 850 20" 0.26mm	1849.00
AppleVision 850AV 20" 0.26mm	1999.00
MAG	
DJ530 15" 0.28mm	289.73
DJ702E 17" 0.28mm	499.23
DJ920 21" 0.28mm	1389.54
MAGNAVOX	
MB5314 15" 0.28mm	329.31
MB7000 17" 0.28mm	459.54
NEC	
A500 15" 0.28mm	319.01
E500 15" 0.25mm	374.91
A700 17" 0.28mm	567.43
E700 17" 0.25mm	659.18
P750 17" 0.25mm	785.91
E1100 21" 0.28mm	1249.22
P1150 21" 0.28mm	1388.76
SONY	
100sf 15" 0.25mm	368.32
100es 15" 0.25mm	369.96
200x 17" 0.25mm	604.03
200f 17" 0.25mm	709.67
202s 20" 0.30mm	984.31
ViewSonic®	
E641 14" 0.28mm	198.12
E655 15" 0.28mm	279.02
G653 15" 0.28mm	1099.09
E771 17" 0.27mm	479.46
EA771 17" 0.27mm black	524.59
G773 17" 0.26mm	529.87
17GA 17" 0.27mm	578.58
G775 17" 0.25mm	645.47
PT775 17" 0.25mm	696.75
G790 19" 0.26mm	865.87
G800 20" 0.26mm	1029.32
G810 21" 0.25mm	1199.98
P810 21" 0.25mm	1285.48
PT813 21" 0.28mm	1364.56
PT815 21" 0.25mm	1429.71

**VIDEO BOARDS**

Nexus GA 8MB PCI	496.20
Xclaim TV external TV tuner	79.79
Xclaim 3D 4MB PCI	177.03
Xclaim 3D 8MB PCI	225.32
Xclaim VR 2MB PCI	169.38
Xclaim VR 4MB PCI	239.98
Turbo TV video capture	98.19
Twin Turbo 128M2 2MB PCI	215.64
Twin Turbo 128M4 4MB PCI	309.66
Twin Turbo 128M8 8MB PCI	539.68

**COMMUNICATIONS**

Megahertz 33.6 Ethernet	299.16
10BT PC Card w/RJ11	76.62
Sportster Scope 33.6 external	139.07
Sportster 33.6 external	139.07
Sportster 56k x2 faxmodem external	217.99
Courier I-modem	339.78

**COMMUNICATIONS**

Delta Village	
TelePort 56K x2 external	149.46
TelePort 56K 56Flex external	149.60
56K bps fax/modem PC Card	249.11
56K bps fax/modem/Ethernet PC Card	349.14
Hayes	
ACCURA 336 external	137.56
ACCURA 56K external	176.51

**DATA STORAGE**

iomega	
Zip drive 100MB SCSI external	139.99
100MB Zip disk	19.95
100MB Zip disk 3-pack	49.95
Jaz Drive 1GB SCSI-2 external	399.95
1GB Jaz disk	124.95
1GB Jaz disk 3-pack	299.95
Jaz Jet PCI SCSI interface for Power Mac	99.95
LACIE	
2.1GB Quantum ST Ultra SCSI-3 internal	279.00
3.2GB Quantum ST Ultra SCSI-3 internal	349.00
4.3GB Quantum ST Ultra SCSI-3 internal	429.00
6.4GB Quantum ST Ultra SCSI-3 internal	569.00
9.1GB Quantum Ultra SCSI-3 internal	1139.00
1.2GB Apple drive Ultra SCSI-3 external	349.00
2GB Apple drive Ultra SCSI-3 external	469.00
3GB Apple drive Ultra SCSI-3 external	539.00
4GB Apple drive Ultra SCSI-3 external	599.00

**Quantum**

1.6GB Fireball ST Ultra-ATA	159.97
2.1GB Fireball ST Ultra-ATA	199.87
2.1GB Fireball ST Ultra-SCSI	239.15
3.2GB Fireball ST Ultra-ATA	235.52
3.2GB Fireball ST Ultra-SCSI	324.21
4.3GB Fireball ST Ultra-ATA	279.32
4.3GB Fireball ST Ultra-SCSI	367.07
6.4GB Fireball ST Ultra-ATA	384.93
6.4GB Fireball ST Ultra-SCSI	485.37

**SyQuest**

EZFlyer 230MB external	149.00
EZFlyer 230MB cartridge	24.99
SyJet 1.5GB SCSI internal	299.00
SyJet 1.5GB SCSI external	399.00
SyJet 1.5GB cartridge	125.00

**INPUT DEVICES**

AGFA	
ePhoto 307 digital camera	285.20
SnapScan 600 flatbed scanner	389.05
StudioStar flatbed scanner	818.80
Arcus 11 flatbed scanner	1319.72
ALPS	
Portable GlidePoint	43.38
Desktop GlidePoint	69.84
GlidePoint Keyboard	109.61
GlidePoint Keypad	115.18

**EPSON®**

PhotoPC digital camera	349.00
PhotoPC 500 digital camera	399.00
PhotoPC 600 XGA digital camera	799.00
Action Scanning System II	279.88
ES-1000C color flatbed scanner	299.24
Expression 636 Executive scanner	799.00
Expression 636 Artist scanner	999.00
Expression 636 Professional scanner	1399.00

**INPUT DEVICES**

HEWLETT-PACKARD	
HP ScanJet 6100cse flatbed scanner	799.00
Kodak	
DC20 digital camera	179.48
DC50 digital camera w/Zoom lens	289.34
DC120 digital camera w/Zoom lens	499.00
DC210 digital camera	899.00
MICROTEK	
Color PageWiz personal scanner	155.05
ScanMaker V300 scanner	139.41
ScanMaker E3 scanner	145.34
ScanMaker E6 Standard scanner	284.34
ScanMaker E6 Professional scanner	529.97
Nikon	
Coolpix 300 digital camera	674.04
AX-210 ScanTouch flatbed scanner	569.78
LS-20 Super CoolScan II	809.09
Super CoolScan film scanner	1759.31
Polaroid	
PDC 2000/40 digital camera	1445.40
SprintScan 35LE film scanner	796.54
SprintScan 35ES film scanner	1459.21
SprintScan 35s film scanner	1827.00
UMAX	
Astra 600S flatbed scanner	169.55
Astra 1200S flatbed scanner	279.07
w/Full Adobe PhotoDeluxe	279.07
w/Full Adobe Photoshop	519.31
PowerLook II	1395.00
VISIONEER	
PaperPort vx scanner	147.53

**PRINTERS**

LaserWriter 4/600 PS	819.71
LaserWriter 12/640 PS	1564.22
LaserWriter 16/600 PS	1799.52
LaserWriter 8500	2399.29
Color LaserWriter 12/660 PS	4286.57
Color StyleWriter 4100	237.03
Color StyleWriter 4500	325.18
Color StyleWriter 6500	469.68
EPSON®	
Stylus Color 600	369.00
Stylus Color 800	399.00
Stylus Color 1520	799.00
Stylus Color 3000	1999.00
Stylus Photo	499.00
HEWLETT-PACKARD	
HP DeskJet 340 portable ink jet printer	295.01
HP DeskJet 870Cxi printer	388.71
HP DeskJet 1600CM printer	1969.33
HP LaserJet 6MP printer	879.85
HP LaserJet 5M printer	1609.51
HP LaserJet 55i MX printer	3556.38

**UPS SYSTEMS**

PowerChute software for Novell NetWare	59.20
Back-UPS Office	139.15
Back-UPS 200	89.91
Back-UPS 400	144.44
Back-UPS 600	239.24
Smart-UPS 450NET	315.03
Smart-UPS 700NET	389.49
Smart-UPS 1000NET	538.15
Smart-UPS 1400NET	675.25
SurgeArrest P7 Home	9.92
SurgeArrest Personal	19.40
SurgeArrest Pro	28.15
SurgeArrest Network	29.95

**800-509-4239**

**www.cdw.com**

**Visit CDW® on the Internet for information on more than 12,000 products**



than just a great price... We're great **service** too!

**NEC**  
NEC Technologies  
**MultiSync A700**  
17" color monitor

- 17" flat square technology CRT, 15.6" viewable image size
- 0.28mm dot pitch
- Maximum resolution: 1280 x 1024 at 65Hz
- 3-year CRT, parts and labor warranty



**\$567.43** CDW 91661

**Zip™ drive**

- 100MB uncompressed/200MB compressed capacity on a single Zip disk
- 29ms seek time; up to 1.25 MB/second sustained transfer rate
- SCSI interface



**\$139.99**  
CDW 51390

**PRICE DROP!**

**NEW!** Zip Plus **\$199.95** CDW 94951

With AutoDetect™—the speed of SCSI and the flexibility of parallel connections

**EPSON®** Includes Look Your Best Color Pak  
**Stylus Color 600**



- 1440 x 720 dpi photo quality color and laser quality black text on premium paper
- 720 x 720 dpi photo quality color and laser quality black text on plain paper
- Print speeds: up to 6 ppm black; up to 4 ppm color

**PRICE DROP!** **\$269.00** CDW 80668

**CDW® CARRIES MORE THAN 20,000 PRODUCTS! IF YOU DON'T SEE IT, CALL!**

**SOFTWARE**

Acrobat V3.0.1 CD.....	179.73
After Effects V3.1 CD.....	509.05
Illustrator V7.0 CD.....	369.96
Illustrator V7.0 competitive upg CD.....	129.66
Illustrator V7.0 version upg CD.....	115.73
PageMaker V6.5 CD.....	549.48
PageMaker V6.5 competitive upg CD.....	178.17
PageMaker V6.5 version upg CD.....	89.87
PageMill V2.0 upg CD.....	95.32
Persuasion V4.0 CD.....	239.90
Persuasion V4.0 upg CD.....	115.72
PhotoDeluxe CD.....	49.47
Photoshop V4.0 CD.....	549.29
Photoshop V4.0 version upg CD.....	159.58
Premiere V4.2 CD.....	487.92
Premiere V4.2 upg CD.....	129.65
Type Manager Deluxe V4.0 CD.....	62.37
Type Reunion Deluxe V2.0.....	38.14

**ClarisWorks Office**  
**\$88.85** CDW 92035

\* \$30 mail-in upg/comp upg manufacturer rebate through 9/30/98. Restrictions apply, please call for details.

OmniForm V2.0.....	129.33
OmniPage Direct V2.0.....	57.64
OmniPage Pro V7.0 CD.....	475.36
OmniPage Pro V7.0 upg CD.....	115.10

Conflict Catcher V4.0.....	59.01
----------------------------	-------

ClarisDraw V1.0.....	179.75
ClarisImpact V2.0.....	79.00
ClarisWorks V5.0 CD.....	89.58
Emailer V2.0.....	42.17
FileMaker Pro V3.0 server.....	889.09
FileMaker Pro V3.0 server upg.....	276.60
Home Page V2.0 CD.....	86.99
Organizer V2.0.....	63.20

RAM Doubler 2.....	53.80
Speed Doubler 2.....	53.91
Speed Doubler 8.....	54.20
VideoPhone V2.0 (software only).....	54.66
Virtual PC w/PC DOS CD.....	64.90
Virtual PC w/Win 95 CD.....	134.76
Virtual PC w/Win V3.1 CD.....	132.76

**SOFTWARE**

Corel Gallery V1.0 CD.....	19.80
Corel Gallery V2.0 CD.....	34.96
Corel Mega Gallery CD.....	62.09
Corel Print House CD.....	28.88
Corel Stock Photo Library 1 CD.....	865.75
Corel Stock Photo Library 2 CD.....	869.80
Corel Stock Photo Library 3 CD.....	886.75
Corel Super Ten Select Photos CD.....	35.88
Corel WEB.GALLERY CD.....	61.61
Corel WordPerfect V3.5 CD.....	155.92
Corel WordPerfect V3.5 upg CD.....	79.92
CorelDRAW 6 Suite CD.....	369.01
CorelDRAW 6 Suite upg CD.....	135.23

Phone Search USA V3.0.....	28.60
Street Atlas USA V4.0.....	39.91
Street Atlas USA V4.0 and Phone Search USA V3.0 value pack.....	52.88
Tripmate.....	144.60

Canvas V5.0 3.5 + CD.....	385.29
Canvas V5.0 competitive upg.....	138.26
Ultra Paint Home V1.0.....	18.25

DeBabelizer Lite V1.1.....	64.00
DeBabelizer Toolbox V1.6.....	229.54
DeBabelizer Toolbox V1.6 5-user.....	929.50

Cyberpress V1.0.....	129.21
Intelligence V3.0 CD.....	89.78
MaskPro V1.0 CD.....	269.45
Page Tools V2.0.....	89.70
PhotoTools V2.0 CD.....	116.62
Portfolio V3.0 CD.....	89.27
Preflight Pro.....	89.78
QuarkXPress Power Trio.....	179.41
QX Effects.....	116.62
QX-Tools V2.0 CD.....	88.04
VectorTools V2.0 CD.....	89.64

**FileMaker Pro V4.0**  
Upgrade CD **\$88.52** CDW 96405  
CD **\$179.41** CDW 96404

CD-ROM Toolkit V2.0.....	48.24
Hard Disk Toolkit V2.01.....	48.66

Blueprint V5.0.....	189.53
MiniCAD V7.0.....	514.41

SoftWindows 95 V4.0 CD.....	174.99
SoftWindows for Performa.....	115.50
SoftWindows V3.0 CD.....	128.28

**SOFTWARE**

QuickBooks Pro V4.0.....	179.58
QuickBooks V4.0.....	109.53
QuickBooks Deluxe 98.....	41.93
QuickBooks Deluxe 98 CD.....	59.99

Authorware 4 CD.....	2048.29
Authorware 4 Interactive Studio CD.....	2065.72
Director 6 upg CD.....	385.35
Director Multimedia Studio 6 CD.....	929.66
Director Multimedia Studio 6 upg CD.....	479.57
Flash 2 CD.....	185.78
FreeHand 7 CD.....	379.42
FreeHand 7 competitive upg CD.....	135.17
FreeHand 7 upg CD.....	138.97
FreeHand Graphics Studio 7 CD.....	459.08
FreeHand Graphics Studio 7 competitive upg CD.....	199.45
FreeHand Graphics Studio 7 upg CD.....	184.65
SoundEdit 16 V2.0 CD.....	219.68
SoundEdit 16 V2.0 plus DECK II CD.....	339.58

**NEW!** **Speed Doubler 8** For Mac OS 8  
**\$54.20** CDW 95799

Art Dabbler.....	42.18
Bryce 2 Accessory Kit CD.....	47.95
Bryce 2 CD.....	179.00
Detailer CD.....	87.10
Expression CD.....	127.27
Kai's Photo Soap CD.....	41.91
Kai's Power Goo CD.....	49.95
Kai's Power Tools 3 CD.....	129.00
KPT Actions Accessory Kit CD.....	42.18
Painter V2.0 CD.....	259.16
Painter V2.0 upg CD.....	80.57
Poser V2.0 CD.....	119.79
Poser V2.0 upg CD.....	62.22
Ray Dream Designer V4.1.....	89.36
Ray Dream Studio V5.0 CD.....	259.08
Ray Dream Studio V5.0 upg CD.....	89.08
Infini-D V4.0 CD.....	499.14

CodeWarrior Discover Programming.....	62.90
CodeWarrior for BeOS.....	118.86
CodeWarrior for PalmPilot.....	298.53
CodeWarrior Latitude.....	328.71
CodeWarrior Professional CD.....	479.83
CodeWarrior Professional upg CD.....	359.78

Bookshelf 98 CD.....	43.73
Cinemania 97 CD.....	29.03
Encarta Deluxe 97 CD.....	67.18
Excel V5.0.....	298.83
Excel V5.0 upg.....	115.37
Flight Simulator V4.0.....	35.46
FrontPage V1.0 CD.....	134.24
Office V4.2.1 Small Business CD.....	449.76
Office V4.2.1 Small Business upg CD.....	269.77
PowerPoint V4.0 upg.....	115.72
Project V4.0.....	424.45
Project V4.0 upg.....	134.89
Visual FoxPro V4.0.....	445.46
Visual FoxPro V3.0 upg CD.....	267.42
Word V6.0.....	298.83
Word V6.0.1 version upg.....	115.71
Works V4.0.....	43.92

**SOFTWARE**

Select Phone Deluxe 97 CD.....	62.41
Select Phone 97 CD.....	43.22

**SYMANTEC.**  
**Norton Utilities V3.5**  
CD **\$92.93** CDW 88335

Quarkmedia V1.0 CD.....	669.96
QuarkXPress V3.32 CD.....	659.29
Studio Pro V1.75.....	856.86
Vision 3D V4.0.....	58.67

ACT! V1.0 for Newton.....	87.81
ACT! V2.5 upg.....	46.18
ACT! V2.8.....	147.63
Norton Disklock V4.0.....	71.85
Norton Utilities V3.5 CD.....	92.93
SAM AntiVirus V4.5.....	63.87
Suitcase V3.0.....	63.87

**CDW® DIRECTORY**

PC sales.....	800-650-4239
Mac sales.....	800-509-4239
Corporate sales.....	800-280-4239
Corporate software sales.....	800-294-4239
Government and Education sales.....	800-615-4239

**CDW® TELEPHONE HOURS**

Sales  
Monday-Friday 7 a.m.-9 p.m. CT  
Saturday 9 a.m.-5 p.m. CT  
Tech Support for Customers  
Monday-Friday 7 a.m.-9 p.m. CT  
Saturday 9 a.m.-5 p.m. CT

**BUY WITH CONFIDENCE**

**CDW® IS A NASDAQ TRADED COMPANY**  
TICKER SYMBOL CDWC D & B rated S&I Duns 10-762-7952



Credit card charges are not submitted until time of shipment. For your protection, we ship only to your credit card's verified billing address. Freight is calculated as the carrier's actual freight charge plus insurance and packaging material. The cost of insurance is 0.35% (0.0035) of the order total. Packaging materials will not exceed \$4.00 for single package shipments or \$6.00 for multi-package shipments. Before returning any product, you must obtain an RMA number. Non-defective returns are subject to a restocking fee. Software, chips and other electronic components are not returnable. Allow 10 business days for shipping when paying by personal check. All pricing subject to change. For all prices, products and offers, CDW reserves the right to make adjustments due to changing market conditions, product discontinuation, manufacturer price changes, errors in advertisements or other extenuating circumstances. All trademarks and registered trademarks are the sole property of their respective owners.

**CDW® is an Apple Authorized Catalog Reseller - call us for all of your Apple needs!**

**800-509-4239**

**www.cdw.com**

©1997 CDW Computer Centers, Inc.  
MW03048 (04) 300 N Milwaukee Avenue, Vernon Hills, IL 60061  
MACWORLD January 1998 153

Circle 2 on reader service card

**COMPUTER DISCOUNT WAREHOUSE™**



# J&R COMPUTER WORLD

Businesses, Lease Your Next Computer thru the J&R Corporate Sales Division (details below)

Giveaways!

Call (212) 238-9000 for Information.



## Modems

**Global Village 56K PCMCIA FaxModem**  
 •56Kbps Net-capable (K56Flex), 33.6Kbps data, and 14.4Kbps fax  
 •Designed for Apple PowerBooks with PCMCIA slot

**\$279<sup>99</sup>** (GLV 56KPCMCIA)

Global Village TelePort 56K x2 (GLV TELE56KX2) ..... **\$159.99**

Global Village TelePort 56K KFlex (GLV TELE56KFLX) ..... **\$159.99**

U.S. Robotics Ext. Sportster 56K PCMCIA (USR MACSPORT56) ..... **\$219.99**



## Apple Printers

Take off up to **\$100** when you buy this printer with a qualifying computer!

**Apple LaserWriter 4/600**  
 •600 dpi •PostScript level 2 support  
**\$799<sup>99</sup>** (APP M389LLA)

**LaserWriter 12/640 PS**  
 •4MB RAM •Prints up to 12-ppm  
**\$1599<sup>99</sup>** (APP M3977LLA)



## Apple Display

Take off up to **\$300** when you buy this display with a qualifying computer!

**Apple Multiple Scan 15AV Display**  
**\$399<sup>99</sup>** (APP M4614LL/A)

Multiple Scan 720 17" Display (16.1" V/S) (APP M6151LL/A) ..... **\$649.99**

AppleVision 750 17" Display (16.1" V/S) (APP M5238LL/A) ..... **\$849.99**

AppleVision 750-AV 17" Display (16.1" V/S) (APP M5239LL/A) ..... **\$949.99**

AppleVision 850 20" Display (19" V/S) (APP M5229LL/A) ..... **\$1849.99**

AppleVision 850-AV 20" Display (19" V/S) (APP M5228LL/A) ..... **\$1999.99**

## Macworld New York at J&R Computer World

**PRIZES!** **HOLIDAY SHOPPING SHOWCASE**  
**DECEMBER 4, 5, 6, 7, 1997**

**FREE In-Store Demos Show You What To Do with a Mac:**

- "Desktop and Media Creation" by MetaCreations
- "Web Page Designs" • "Video Editing" by Apple
- "Gaming and Edutainment" by IBM
- "CD-ROM Creation" by Philips
- "Digital Photography" by Olympus and MetaCreations
- "PDAs" by Apple Newton and 3COM
- "Internet" - Global Village • "Music Creation" by G-Vox

## The Apple Add-on Take-off Mail-in Rebate

\*Get up to a **\$300** mail-in rebate on select Apple Power Macintosh 6500 or 8600 systems purchased with any Apple Display! Offers good through Jan. 16, 1998.



**Apple Power Macintosh 8600/250**  
**32MB/4GB/24xCD/Zip™**

- 250MHz PowerPC™ 604e processor •32MB RAM •4GB hard drive
- 24x CD-ROM •Iomega™ Zip™ drive
- Monitor sold separately

**\$2599<sup>99</sup>** (APP M5905LL/A)

**\$250** mail-in rebate with the purchase of any Apple Display!

- Apple Power Macintosh 6500/250 ..... (APP M6189LL/A) ..... **\$1999.99 + \$200 rebate\***
- Apple Power Macintosh 6500/300 ..... (APP M6079LL/A) ..... **\$2299.99 + \$200 rebate\***
- Apple Power Macintosh 6500/275 ..... (APP M6191LL/A) ..... **\$2499.99 + \$200 rebate\***
- Apple Power Macintosh 6500/275 ..... (APP M6190LL/A) ..... **\$2799.99 + \$200 rebate\***
- Apple Power Macintosh 6500/300 ..... (APP M6192LL/A) ..... **\$2999.99 + \$200 rebate\***
- Apple Power Macintosh 8600/300 ..... (APP M6092LL/A) ..... **\$3099.99 + \$300 rebate\***

©1997 Apple Computer, Inc. All rights reserved. Apple, the Apple logo, LaserWriter, Macintosh, Power Macintosh, PowerBook, and QuickTake are registered trademarks of Apple Computer Inc. All other trademarks are the property of their respective owners. All Apple products are designed to be accessible to individuals with disabilities. For more information in the U.S. only, call 1-800-766-2333 or TDD 1-800-833-6223.

PowerPC and the PowerPC logo are trademarks of International Business Machines Corporation, used under license therefrom. Apple, the Apple logo, Macintosh, Power Macintosh, PowerBook, Apple SuperDrive & AppleDesign are registered trademarks of Apple Computer, Inc. Zip drive is a trademark of Iomega Corporation.



## J&R CORPORATE SALES BUSINESS LEASING:

**No Money Down, No Payments for 30 Days!**

- 1) Allows flexibility to add or upgrade equipment at any time
- 2) Conserves your capital
- 3) Saves time, credit decisions are quick and easy
- 4) Covers entire packages - equipment, software, service contracts, and peripherals

\*All lease payments are exclusive of applicable taxes. Minimum leasing payment is \$50 per month. All leases are subject to credit approval and require an administrative fee of \$49.95 to be billed on the first invoice. Leasing program administered by Dano Commercial Credit. Leases are Business Leases, 50 down, 36 month term with \$1.00 purchase option.



Call J&R Corporate Sales  
 1-800-221-3191 or  
 1-212-238-9080

(\$1,400 Minimum Lease Amount)

## Entertainment Software



**20th Century Fox Simpsons Virtual Springfield**  
**\$19<sup>99</sup>**

- Ariel's Story Studio by Walt Disney ..... **\$34.99**
- Cat In The Hat by Broderbund ..... **\$39.99**
- Click Art 125,000 Deluxe Image Pack by Broderbund ..... **\$49.99**
- Cosmopolitan Virtual Makeover by SegaSoft ..... **\$34.99**
- Creatures by Mindscape ..... **\$34.99**
- FA-18 Hornet (3.0) by Graphic Sim. .... **\$29.99**



**WizardWorks Quake**  
**\$42<sup>99</sup>**

- Guitar 101 by G-VOX ..... **\$39.99**
- Imperialism by Mindscape ..... **\$42.99**
- Links LS (for Power Macintosh) by Access ..... **\$44.99**
- Master of Orion II by WizardWorks ..... **\$42.99**
- Musician Plus by G-VOX ..... **\$119.99**
- CyberSound Studio 3.0 with Kybd. by CyberSound ..... **\$89.99**

## SUNCOM



**Suncom FX3000 Fully Programmable Joystick for Mac**  
 •Control panel allows creation, modification and saving custom functions or specific games  
 •Pre-programmed templates

**\$39<sup>99</sup>** (SUN FX3000MAC)



**Suncom SXF Plus Game Pad for Mac**  
 •Quick and responsive game control  
 •Comfortable, ergonomic design  
 •12 programmable action buttons  
**\$34<sup>99</sup>** (SUN SXFPLUS)

To Order Toll Free and Receive a Free Catalogue MAIL ORDERS: J&R Computer World

**800-221-8180**

• 59-50 Queens Midtown Expressway • Maspeth, Queens NY 11378  
 CALL 1-800-221-8180 for shipping information. DO NOT SEND CASH.

24 Hours, 7 Days, Anywhere In The USA or FAX us at 1-800-232-4432

Not responsible for typographical or pictorial errors. Some quantities may be limited. All merchandise brand-new, factory-fresh and 100% guaranteed!



**PRIZES!**

PHILIPS CLARIS

Call (212) 238-9000 for Information.

# J&R COMPUTER WORLD

One of America's Largest Authorized Apple Dealers

## Macworld New York at J&R Computer World

**HOLIDAY SHOPPING SHOWCASE** Giveaways!

DECEMBER 4, 5, 6, 7, 1997

**FREE Classes Show You What To Do with a Mac:**

- "Mac OS8, Features and Benefits" by Apple
  - "PC Compatibility" by Connectix
  - "Microsoft Office" by Microsoft
  - "ClarisWorks for Kids" by Claris
  - Question & Answer Sessions with Macworld Editors
- Classes are limited  
Call (212) 238-9000 for information

### Digital Cameras



- Olympus D-600L**  
Digital Still Camera  
**\$1299.99** (OLM D600L)
- Casio QV-70 ..... \$329.99 (CAS QV70)
- Panasonic PV-DC1000 (PAN PVDC1000) ..... \$379.99
- Minolta Dimage V Kit (MIN DIMAGE/KIT) ..... \$499.99
- Olympus D-320L (OLM D320L) ..... \$699.99
- Olympus D-500L (OLM D500L) ..... \$899.99

### Omega Jaz Drives



- Omega**  
2GB External Jaz Drive  
• Pack up to 2GB on each disk (4GB with compression) • Operates in DOS, Windows, Win95, WinNT, Mac environments • Includes 2GB disk  
**\$649.99** (BER JAZEXT2GIG)

- Omega Spare 2GB Disk preformatted for Mac (BER MAC2GIGCART) ... \$169.99
- Omega Spare 2GB Disk 3-Pack for Mac (BER MAC2GIGTR1) ... \$449.99
- Omega Jaz Insider 2GB Drive (BER JAZINT2GIG) ..... \$549.99

### Pacific Image Scanners



- Pacific Image**  
ScanAce III  
with Full Photoshop 4.0  
• Single-pass flatbed scanner • 600 x 1200 dpi optical res • Scans up to 8.5" by 14" • 68.7 billion colors (36-bit) • SCSI cable and terminator  
**\$899.99** after \$100 mail-in rebate (PCF ACEIIIHPH-MA) (Rebate expires 12/31/97)
- ScanAce II Mac Scanner (PCF ACEII-MAC) ..... \$279.99
- ScanAce II with full Photoshop 4.0 (PCF ACEIIHPH-MAC) ..... \$449.99

## The Apple® Add-on Take-off Mail-in Rebate

Receive an Apple® QuickTake® 200 camera or 32MB memory upgrade **FREE** with any Apple Macintosh® PowerBook® 3400 system!  
Mail-in offer good through January 16, 1998.

**Apple® Macintosh® PowerBook® 3400c/180 16/1.3GB/CD**  
• 180MHz PowerPC™ processor • 12.1" active-matrix SVGA display • 16MB RAM • 1.3GB hard drive • 1MB VRAM • 12x CD-ROM • 33.6Kbps modem  
**\$3199.99** (APP M4597LL/B)

Add on either a **FREE** 32MB memory upgrade or Apple QuickTake 200 camera, and more, with purchase!



**Apple® PowerBook 3400/200C/200** • 200MHz PowerPC™ processor • 12.1" active-matrix SVGA display • 16MB RAM • 2GB hard drive • 12x-speed CD-ROM • 1.4MB Apple SuperDrive® • 33.6Kbps modem..... (APP M4595LL/B) .... **\$3799.99 + Add-ons!**

**Apple® PowerBook 3400c/240 16/3GB/12xCD** • 240MHz PowerPC™ processor • 12.1" active-matrix SVGA display • 16MB RAM • 3GB hard drive • 12x CD-ROM • 256K level 2 cache • 33.6Kbps modem..... (APP M5550LL/A) .... **\$4499.99 + Add-ons!**

©1997 Apple Computer, Inc. All rights reserved. Apple, the Apple logo, LaserWriter, Macintosh, Power Macintosh, PowerBook, and QuickTake are registered trademarks of Apple Computer Inc. All other trademarks are the property of their respective owners. All Apple products are designed to be accessible to individuals with disabilities. For more information in the U.S. only, call 1-800-766-2333 or TDD 1-800-833-6223.

PowerPC and the PowerPC logo are trademarks of International Business Machines Corporation, used under license therefrom.

### Business Software

Business Software	Business Software	Business Software	Microsoft Office (4.21)
<b>Claris Works Office</b> \$89.99	<b>Intuit Quicken Deluxe 98</b> \$59.99	<b>Netscape Communicator (4.0) Internet Access Edition</b> \$64.99	<b>Office</b> \$479.99
Conflict Catcher (4.0) Casady & Greene... \$64.99	Illustrator (7.0) Action Pack by Adobe... \$399.99	Norton Utilities (3.5) by Symantec... \$99.99	QuickKeys (3.5.2) by CE... \$89.99
Cu See Me Enhanced (2.1) by White Pine... \$69.99	Intelligence (3.0) by Extensis... \$89.99	PageMill (2.0.1) CD-ROM by Adobe... \$99.99	RAM Doubler (2.0) by Connectix... \$59.99
Eudora Mail Pro (3.1.1) by Qualcomm... \$59.99	Japanese Language Kit (1.2) by Apple... \$139.99	PageMill (2.0.1) CD-ROM/floppy by Adobe... \$99.99	Suitcase (3.0) by Symantec... \$69.99
FileMaker Pro (4.0) by Claris... \$199.99	Kai's Photo Soap by MetaCreations... \$44.99	Phonebook America by Pro CD... \$9.99	Symantec AntiVirus for Mac (4.5) by Symantec... \$69.99
Flash 2 by Macromedia... \$199.99	Mac OS8 by Apple... \$89.99	PhotoTools (1.1) by Extensis... \$99.99	Virtual PC with Windows 95 by Connectix... \$149.99
Hard Disk Toolkit (2.06) by FWB... \$124.99	MacLinkPlus Translators Pro (9.7) by DataViz... \$89.99	QuarkXPress (3.32) by Quark... \$649.99	Works For Kids by Claris... \$39.99

Order Your Free Catalogue Now!

**J&R COMPUTER WORLD**

Apple eMate™ 300  
Only 4 lbs.  
1MB RAM  
2MB Flash RAM  
**\$799.99**

Apple Newton MessagePad™ 2000  
5MB RAM  
Hand-Writing Recognition  
**\$999.99**

Apple Newton MessagePad™ 2000  
5MB RAM  
Keyboard  
Backlit LCD  
**\$1099.99**

All Major Credit Cards Accepted

To Order Toll Free and Receive a Free Catalogue  
**800-221-8180**





# MacConnection

The Original Macintosh Mail-Order Source—Since 1984!

Order as late as 3 am. ET and STILL get Overnight Delivery!

Order Online: www.macconnection.com

Hurry! While Supplies Last

As Low As

**\$799**  
47995



Monitor sold separately

## PRICES SLASHED on StarMax™

**5 year warranty**

### FREE Software

- ✓ Conflict Catcher
- ✓ SAM
- ✓ Norton Utilities
- ✓ FWB Toolkit
- ✓ Adobe Acrobat

### StarMax 3000/5000 Series

- Up to 275MHz 603e PowerPC or 604e PowerPC 200MHz
- 32 or 64MB RAM expandable to 160MB
- Up to 4.3GB Hard Drive
- Up to 16X SCSI CD-ROM Drive
- Up to 50MHz Bus Speed!



StarMax 3000



47995 AMT-3200-N	.....	\$799
(200MHz 603e/32MB/2.5GB/8X/opt. modem)		
47996 AMT-3240-N	.....	949
(240MHz 603e/32MB/4.3GB/8X/28.8K modem)		

47992 AMT-53275EN	.....	\$1199
(275MHz 603e/32MB/2.5GB/16X SCSI/opt. modem)		
47991 AMT-53250EN	.....	1499
(250MHz 603e/32MB/2.5GB/16X SCSI/opt. modem)		
47993 AMT-54200N	.....	1499
(200MHz 604e/64MB/2.5GB/16X SCSI/opt. modem)		

## SAVE Up to \$1000!



Was \$5499  
NOW \$4499

### \$1000 Price Drop, Make It Yours! Apple PowerBook 3400 Series Features

- 603e Processor
  - 12.1" Active Color
  - 16MB RAM
  - 12X CD-ROM
  - 256K Cache
  - 33.6K modem w/10BT Ethernet
- Add an internal VST Zip Drive for only \$299<sup>95</sup>**  
38024
- |                             |       |        |
|-----------------------------|-------|--------|
| 41446 Apple PowerBook 3400C | ..... | \$3199 |
| (180MHz/16MB/1.3GB)         |       |        |
| 41445 Apple PowerBook 3400C | ..... | 3799   |
| (200MHz/16MB/2.0GB)         |       |        |
| 38464 Apple PowerBook 3400C | ..... | 4499   |
| (240MHz/16MB/3.0GB)         |       |        |

### ORDER TODAY!

**FileMaker Pro 4.0**

Create powerful databases and take them to the Web!

Only **\$99**

44990

**Quicken Deluxe 98**

Discover new ways to make the most of your money!

Only **\$39.95\***

46302

\*After \$20 mfr.'s mail-in rebate

**REUNION 5.0**

Dig up the roots of your family tree! Create family timelines, genealogy charts, more!

Only **\$99.95**

44177

**FREE Action Pack**

FREE! w/purchase of full version of PageMaker, Photoshop or Illustrator!

**Over \$1000 Value FREE!**

HURRY! Limited Time Offer While Supplies Last! Call for details

**Peripherals!**

**MOTOROLA Lifestyle 33.6**

**NEW! ONLY \$49.95**

47628

Surf the Net F-A-S-T for not a lot of money!

**Canon BJC-4550 Printer**

31539

Big, beautiful, photo-quality prints up to 11" x 17"!

Amazing 720 x 360 dpi color!

Incredible price for Canon Quality!

Only **\$299**

**NEW! Iomega ZipPlus**

Everything a Zip Drive has ... Plus!

• Faster performance

• One-drive-fits-all design

• Cool multimedia software

Only **\$199.95**

44705

**NEW! EPSON Perfection 600 Scanner**

46647

• New, versatile flatbed scanner for business!

• FREE award-winning premium software!

Only **\$299**

**NEW! Seagate Cheetah 9.1GB HD**

10,000 RPM

Internal Ultra Wide SCSI

4531

Only **\$1199**

**MAXpower Citation CPU Upgrade Card**

• Best-Value 604e Processor Upgrade!

• Easy plug-and-play installation!

Up to 260% faster!

47595

Only **\$349.95**

**USR PalmPilot Pro Bundle**

Get the best-selling handheld PC at a new lower price, PLUS FREE PalmPilot Hard Cover (a \$9.95 value!) PLUS "Pick-a-Present" promotion!

- 1MB of memory for storing over 8,000 records
- Easy one-time setup

Now only **\$349.95**

47566

**NEW! Economical 4-color printing! Apple Color StyleWriter 450**

• 600 x 600 dpi black and white; 600 x 300 dpi color

• Up to 5 pages per minute

• Includes a built-in 100-sheet paper tray, free software, and everything you need to get started

• Serial cable and cartridges include

Only **\$339**

42059

**7-Time Winner! Best Mail-Order**

1990-1996

OUR POLICY • VISA, MASTERCARD, AMERICAN EXPRESS, and NOVUS cards. No surcharge. • Most products are covered by manufacturer's warranty against defects for at least 30 days from the invoice date. • All returns require prior authorization; please call for an RMA. • We are not responsible for typographical errors. • Pricing and promotions are subject to change without notice. Continental U.S.: Shipping Charge: \$4.95 per order up to 3 pounds. On orders over 3 pounds, shipping is \$4.95 plus an additional \$1.25 per pound or fraction thereof. Please call for weight charge information. Items of excessive size and/or weight may require additional days to deliver via a freight carrier. Please check with your sales rep for more details. Barring events beyond our control, all credit card orders placed in weekdays by 3 a.m. ET will ship Airborne Express the next business day. Saturday delivery available to many areas upon request at no additional charge. Order all day Saturday thru noon Sunday for Monday delivery. Some areas require an extra day delivery. APO/FPO, International orders and Hawaii, Alaska, Canada, Puerto Rico, U.S. Virgin Islands: Shipping will require additional time and charges. All other areas: Call 803-446-4444 or FAX 803-446-7731. M-F 9 a.m.-5:30 p.m. ET. ©1997 PC Connection, Inc., Millard, NH. MacConnection & the raccoon characters are registered trademarks of PC Connection, Inc. All other trademarks remain the property of their respective companies.



# Get the Best for Less!

**NEW!**  
 Extended service plan  
 Supplements the manufacturer's warranty for a full 4 years from date of purchase!



**Newest, Hottest Version!**  
**Newton MessagePad 2100**

**Only \$999**

Everything you want in a portable computer, without the bulk, weight and short battery life!

**FREE**  
 With any MessagePad 2100 - Lunarlanding, SubPatrol and 2 WriteRights! (\$70 value)

- 162MHz StrongArm SA-110 RISC processor
  - 8MB RAM (4MB DRAM, 4MB Flash)
  - 8MB ROM
  - Built-in microphone and speaker
- 45215 8MB Flash Card FR ..... \$99.95  
 45220 16MB Flash Card FR ..... 169.95



**NEW! The Most Power-Packed Home Mac Ever!**  
**Power Mac 6500 Series**

**Start At Only \$1799\***

**\$200 Rebate!**  
 Call for details

Mac OS 8 included on NEW Models!  
 MS Office included on Business Models

- 45745 Apple Power Mac 6500 ..... \$1799\*  
 (250MHz/32MB/4GB/24X/56K modem)  
 45748 Apple Power Mac 6500 ..... 2299\*  
 (275MHz/32MB/6GB/24X/56K modem & Zip Drive)  
 45746 Apple Power Mac 6500 ..... 2599\*  
 (275MHz/48MB/6GB/24X/56K modem & Zip Drive)  
 45750 Apple Power Mac 6500 ..... 2799\*  
 (300MHz/64MB/6GB/24X/56K modem & Zip Drive)

\*After mail-in rebate when purchased with qualifying apple display.



**Start At Only \$1995**

**NEW!**

**UMAX J700**  
 The fastest, most upgradeable mid-range computing solution!

- 233MHz 604E PowerPC Processor
  - 24MB RAM
  - 2.0GB IDE HD
  - 24X CD-ROM
  - 512K L2 Cache
  - 33.6 External Modem
- 47170 UMAX J700 ..... \$1995  
 (233MHz 604E/2GB/24MB/24X/33.6K modem)

**Upgradeable Processor!**

## Best Deals on Hardware & Software!

<b>Utilities</b>	43866 Adobe PageMaker 6.5 ..... 539.95	<b>CD-ROM</b>	38365 La Cie Ext 2x6 CD-R Drive w/ Toast ..... 399
42673 Virtual PC w/Mech Warrior 2 ..... 147.95	44942 Adobe Illustrator 7.0 ..... 369.95	38347 MDS 12X External SCSI CD-ROM ..... 139.95	46415 Hi-Val Sountastic 24X CD-ROM ..... 189.95
37633 Conflict Catcher Mac ..... 64.95	31327 GoLive CyberStudio 2.0 ..... 289.95	46412 MDS 24X External SCSI CD-ROM ..... 179.95	
32164 Symantec Antivirus Mac (SAM) ..... 69.95		<b>Digital Cameras</b>	39582 Kodak DC120 Digital Zoom ..... 799
44801 Private File ..... 47.95	<b>Games</b>	45096 Ricoh RDC-300 Digital Camera ..... 499	43512 Sandisk 20MB Compact Flash w/PCMCIA Adapter ..... 299.95
44802 Aladdin Flashback ..... 27.95	43330 Civilization II ..... 47.95	43841 Fuji DX-5 Digital Camera ..... 299.95	
43375 FWB Storage Wizard ..... 34.95*	43329 Quake ..... 47.95	<b>Graphics/Video Cards &amp; Accelerators</b>	44886 ATI Nexus GA ..... 549
*After manufacturer's rebate	42144 Diablo for Mac ..... 46.95	440281 Imagine 128 Ser2 8M PCI ..... 799.95	37869 IMS Turbo TV PC & Mac TV Card ..... 99
43757 Miramar PC MacIn Remote ..... 159.95	40728 Duke Nukem 3D ..... 49.95	45169 MAXpower Pro ..... 1249	40465 RenderPix 502-A ..... 2995
41769 Dantz Retrospect ..... 149.95	42119 Starfleet Academy ..... 49.95	<b>Monitors</b>	28602 Hitachi MC20 20" ..... 1399
<b>Business</b>	<b>Personal Productivity</b>	38305 Mag Innovation 710V2 17" ..... 499	32695 Mag Innovation DX700T 17" ..... 699
43105 ClarisWorks Office for Mac ..... 99*	46966 Tripmate for Mac ..... 159.95	36276 Mitsubishi 91 TXM 21" ..... 1549	39386 ViewSonic Optiquest Q53 15" ..... 299.95
*\$30 rebate for upgrade tradeup customers	43723 Street Atlas USA 4.0 for Mac ..... 42.95		
32253 Quicken Deluxe 98 ..... 59.95	44178 Reunion 5 upgrade from Reunion 4 ..... 39.95		
39704 FastTrack Schedule 5.0 ..... 169.95	24643 Learn to Speak Spanish ..... 79.95		
45026 Employee Manual Maker 4.0 ..... 89.95	43258 Complete National Geographic Magazine 108 years ..... 169.95		
39315 Working Papers ..... 149.95	<b>Accessories</b>		
44990 FileMaker Pro 4.0 Tradeup/Upgrade ..... 99	39536 Kensington Orbit ..... 69.95		
<b>Graphics &amp; Design</b>	32497 Masterlock Notebook Security Cable ..... 39.95		
41786 Fusion 2.0 for Mac ..... 294.95	25696 Mouse in the Box ..... 39.95		
35801 Eye Candy 3.0 Power Mac (CD) ..... 119.95	33990 Solar Panel Mercury II ..... 299.95		
40602 Portfolio 3.0 ..... 94.95			
43868 Adobe Photoshop 4 ..... 539.95			

**RIVEN**  
 THE SEQUEL TO MYST

**Official Riven Solutions Guide**  
 47662

**In Stock!**  
**\$49.95**

45897

**Only \$8.95**

**FREE!**  
**CALL TODAY!**

for your FREE  
 C Connection  
 or MacConnection  
 catalog subscription!  
 mention source code 198MW)

800-600-8254

**SUPER LOW SIMMS!**

**8MB** as low as \$29.95

**16MB** as low as \$49.95

**32MB** as low as \$99.95

**Memory as low as \$3.12 per MB**

**FREE SERVICE!**  
 Custom Configured Systems

Call for details!

**Start Saving!**

ask about...  
**LEASING OPTIONS**  
 for BUSINESS  
 CALL 800-800-0014

**20,000 HOT PRODUCTS 24 HRS A DAY!**

**800-600-8254**

**www.macconnection.com**  
 Now shop on-line with a name you can trust!

**198MW**

Circle 145 on reader service card

MACWORLD January 1998 157



# ProDirect

## 800-524-9952

Service \* Performance \* Price \* Always



At ProDirect, we work closely with drive manufacturers to identify and optimize key internal mode settings. This enables our hard drives to operate at peak efficiency. We call it Speed-Tuning™ and it works. The proof is in the award. AGAIN!

May '97 June '97 Aug '97



"TEST DRIVE" ANY HARD DRIVE WE SELL FOR ALMOST 3 MONTHS WITH OUR UNBEATABLE 90 DAY PERFORMANCE GUARANTEE.



**ProDIRECT means...**

- Toll-Free Tech Support
- Same Day Shipping
- No Sales Tax Outside MN
- Reseller Pricing Available
- Educational and Government Discounts Available
- Never a Surcharge!

**FREE SHIPPING! Just Ask!**

Ad No. WD198

**MICROPOLIS**

**TOMAHAWK AV**

4.5GB Wide (M4345WAV) \$515

9.1GB Wide (M3391WAV) \$875

8ms Seek 2048K Buffer 7200 RPM 5 Year Warranty

**TOMAHAWK**

9.1GB (M3391) \$810

8ms Seek 512K Buffer 7200 RPM 5 Year Warranty

**CAPRICORN**

4.3GB (M3243) \$339

8.5ms Seek 512K Buffer 7200 RPM 5 Year Warranty

**STINGER** Value In 4 GB

4.5 GB (M4743N) \$325 \$375

9ms Seek 512K Buffer 5400 RPM

4.5 GB (M4743W) WIDE \$330 \$410

**TOMAHAWK AV**

WOW! 2MB AV BUFFER

4.5 GB (M4345AV)	\$505	\$565
4.5 GB (M4345WAV) WIDE	\$515	\$595
9.1 GB (M3391AV)	\$840	\$895
9.1 GB (M3391WAV) WIDE	\$875	\$955

8ms Seek 2048K Buffer 7200 RPM

**TOMAHAWK**

EXCELLENT VALUE & RELIABILITY

4.1 GB (M4341N)	\$465	\$525
4.5 GB (M4341W) WIDE	\$495	\$575
4.5 GB (M4345N)	\$485	\$545
4.5 GB (M4345W) WIDE	\$495	\$575
9.1 GB (M3391N)	\$810	\$870
9.1 GB (M3391W) WIDE	\$830	\$910

8ms Seek 512K Buffer 7200 RPM

**ULTRASTAR ES**

RELIABILITY \* SPEED \* VALUE

2.1 GB (DCAS32160S)	\$265	\$315
4.3 GB (DCAS34330S)	\$385	\$435
4.3 GB (DCAS34330W) WIDE	\$435	\$515

8ms Seek 512K Buffer 5400 RPM

**Seagate**

**CHEETAH**

FASTEST DRIVE RUNNING

THE CHEETAH FAMILY BOASTS A 10,000 RPM SPINDLE SPEED WHICH GREATLY ENHANCES ITS OVERALL PERFORMANCE.

4.5GB Wide (ST34501W) \$675

9.1GB Wide (ST19101W) \$1110

7.9ms Seek 10,000 RPM 512 CACHE BUFFER

**BARRACUDA**

4.5GB Wide (ST34572W) \$575

9.1GB Wide (ST19171W) \$965

8ms Seek 512K Buffer 7200 RPM 5 Year Warranty

**CHEETAH** 7.9ms Seek 10,000 RPM 512K Buffer

4.5 GB (ST34501N)	\$655	\$715
4.5 GB (ST34501W) WIDE	\$675	\$755
9.1 GB (ST19101N)	\$1085	\$1145
9.1 GB (ST19101W) WIDE	\$1110	\$1190

**BARRACUDA** LEGENDARY PERFORMANCE!

2.5 GB (ST32272N)	\$365	\$425
2.5 GB (ST32272W) WIDE	\$395	\$475
4.5 GB (ST34572N)	\$565	\$625
4.5 GB (ST34572W) WIDE	\$595	\$675
9.1 GB (ST19171N)	\$935	\$995
9.1 GB (ST19171W) WIDE	\$965	\$1045

**ELITE AWESOME CAPACITY!**

23 GB (ST423451N)	\$1775	\$1875
23 GB (ST423451W) WIDE	\$1805	\$1905

11ms Seek 5400 RPM 2048 Buffer

**Quantum**

CAPACITY FOR THE EXTRAORDINARY™

**VIKING**

4.5GB (Q34550VK) \$475

8.5ms Seek 512K Buffer 7200 RPM 5 Year Warranty

**ATLAS II**

2.5GB (Q32275) \$325

9.1GB (Q39100) \$855

8ms Seek 1024K Buffer 7200 RPM 5 Year Warranty

**VIKING** ULTRA VALUE & PERFORMANCE

2.5 GB (Q32275VK)	\$355	\$405
4.5 GB (Q34550VK)	\$475	\$535
4.5 GB (Q34550VKW) WIDE	\$485	\$565
2.5 GB (Q32275N)	\$325	\$385
2.5 GB (Q32275W) WIDE	\$335	\$415
4.5 GB (Q34550W) WIDE	\$555	\$615
4.5 GB (Q34550WV) WIDE	\$575	\$655
9.1 GB (Q39100N)	\$855	\$905
9.1 GB (Q39100W) WIDE	\$875	\$945

8ms Seek 512K Buffer 7200 RPM 5 Year Warranty

**STRATUS**

2.1 GB NEW HEIGHTS	\$229	\$279
3.2 GB OF PERFORMANCE	\$289	\$349
4.1 GB AND VALUE	\$335	\$385
6.4 GB	\$455	\$505

9.5ms Seek 128K Buffer 5400 RPM 5 Year Warranty

**Ultra SCSI Acceleration Cards**

ATTO Express PCI Ultra SCSI Channel. 31

ATTO DualChannel Express PCI Ultra SCSI 3 40 MB/Sec. 58

FWB JackHammer Fast/Wide 16BIT SCSI 2 for Nubus Macs. 48

FWB PCI JackHammer Single Channel. Ultra SCSI PCI 34

ADAPTEC PowerDomain 2940 UWM Single Channel PCI 24

ADAPTEC PowerDomain 3940 UWM Dual Channel PCI 23

# Get a PowerRAID™ for Maximum Mac Transfer Rates

**ProDirect** BEST BUY

MacUser 8/97

"The fastest array in this test, the ProDirect PowerRAID M18"

RAID Level 5 Available. Great for Servers!

**Seagate ProDirect PowerRAID**

8 GB DRIVES ACCEL CHANNEL FIXED HOT-SWAP

8	Barracuda ST3471W	Single	1895	2095
18	Barracuda ST19171W	Single	2895	2995
36	Barracuda ST19171W	Single	5295	5695
54	Barracuda ST19171W	Single	7995	8525
63	Barracuda ST19171W	Single	9295	9995

MICROPOLIS ProDIRECT PowerRAID

8	Tomahawk M4345WAV	Single	1795	1895
18	Tomahawk M3391WAV	Single	2795	2895
36	Tomahawk M3391WAV	Single	4995	5395
54	Tomahawk M3391WAV	Single	7795	8325
63	Tomahawk M3391WAV	Single	8895	9695

**Seagate ProDirect PowerRAID**

8 GB DRIVES ACCEL CHANNEL FIXED HOT-SWAP

8	Barracuda ST3471W	Single	1895	2095
18	Barracuda ST19171W	Single	2895	2995
36	Barracuda ST19171W	Single	5295	5695
54	Barracuda ST19171W	Single	7995	8525
63	Barracuda ST19171W	Single	9295	9995

MICROPOLIS ProDIRECT PowerRAID

8	Tomahawk M4345WAV	Single	1795	1895
18	Tomahawk M3391WAV	Single	2795	2895
36	Tomahawk M3391WAV	Single	4995	5395
54	Tomahawk M3391WAV	Single	7795	8325
63	Tomahawk M3391WAV	Single	8895	9695

**Seagate PowerRAID SC18**

18GB CHEETAH SPEED DEMON!

This RAID features drives rotating at 10,000 RPM which greatly enhances the overall transfer rate of this 18 GB RAID.

FIXED \$3375

REMOVABLE \$3575

**MICROPOLIS PowerRAID M18**

18 GB MICROPOLIS ULTRA WIDE

"The fastest array in this test, the ProDirect PowerRAID M18"

MacUser 8/97

FIXED \$2795

REMOVABLE \$2995

Incredible 4 MB Cache Buffer for Max. AV Transfers

**Seagate ProDirect PowerRAID**

8 GB DRIVES ACCEL CHANNEL FIXED HOT-SWAP

8	Barracuda ST3471W	Single	1895	2095
18	Barracuda ST19171W	Single	2895	2995
36	Barracuda ST19171W	Single	5295	5695
54	Barracuda ST19171W	Single	7995	8525
63	Barracuda ST19171W	Single	9295	9995

MICROPOLIS ProDIRECT PowerRAID

8	Tomahawk M4345WAV	Single	1795	1895
18	Tomahawk M3391WAV	Single	2795	2895
36	Tomahawk M3391WAV	Single	4995	5395
54	Tomahawk M3391WAV	Single	7795	8325
63	Tomahawk M3391WAV	Single	8895	9695

**Awesome Memory Prices**

HIGHEST QUALITY LIFE TIME WARRANTY

PRICES SLASHED!

DIMMS 168 PIN 60ns		SIMMS	
SIZE	5V0lt FAST PAGE EDO	3 V0lt 30 MIN. DELAY EDO	72 PIN, 30 PIN 60ns, 70ns
4 MB	n/a	n/a	18 24
8 MB	26 26	26 24	24 24
16 MB	53 53	53 53	46 99
32 MB	99 99	99 99	93 n/a
64 MB	199 199	199 199	n/a n/a
128 MB	call call	call call	n/a n/a

**REMOVABLE STORAGE DRIVES**

**Omega ZIP**

100 MB Removable with One Cartridge

External: \$148

Internal PowerMac: \$158

Internal Mac Clones: \$138

ZIP Cartridges \$15.95 ea.

\$12. ea. in 10-pack after rebate

**Omega JAZ**

1GB Removable with One Cartridge

External: \$399

Internal PowerMac: \$298

Internal Mac Clones: \$278

JAZ Cartridges \$88 ea.

**YAMAHA CD-R400**

6X Reader 4X Writer ONLY \$575

2MB Buffer with Toast Pro CD-R Software

650 MB CDR Media \$3.99 w/CDR Purchase

**SyQuest SyJet**

1.5 GB Removable with One Cartridge

External: \$489

SyJet Cartridges \$98 ea.

**Hot, New Tape Back-up Drives**

RETROSPECT SOFTWARE INCLUDED

WOW! INCREDIBLE DLT 4000 40GB

TRANSFER RATE: 150 MB/MIN

\$3995

IN STOCK TODAY

SPEEDY TAPE DRIVES PERFECT FOR AV WORK OR SERVER

SPECTACULAR SPEED 0053 DAT SONY 5000 24GB

TRANSFER RATE: 150 MB/MIN

\$1175

**ON THE FLY INSTANT BACKUP!**

CAPACITY	MODEL	TRANSFER RATE	SALE
8 GB	HP 1599	90 MB/Min.	1145
8 GB	CTD8000	60 MB/Min.	795
8 GB	Sony 7000	90 MB/Min.	975
24 GB	HP1554 DDS3	120 MB/Min.	1445
24 GB	Sony 9000 DDS2	120 MB/Min.	1175
48 GB	HP1553 DDS2	60 MB/Min.	2485
144 GB	SC ATITC 5025 2mm	120 MB/Min.	3995
150 GB	DLT™ 2500XT	150 MB/Min.	4895
210 GB	DLT™ 2700XT	150 MB/Min.	6535
200 GB	DLT™ 4000	180 MB/Min.	6525
280 GB	DLT™ 4700	180 MB/Min.	7995

Additional Discounts on Memory Apply with System Purchase. Ask for details.

ProDirect 10830 Nesbitt Ave South Bloomington, MN 55437

800-524-9952

Hours: M-F 8AM-7PM Sat. 10AM-3PM International Orders: 612-884-0012

ProDirect Fax: 612-941-1109 Toll Free Tech Support 800-524-9952 Internet: www.pdusa.com E-mail: info@pdusa.com

ALL PRICES ARE SUBJECT TO CHANGE WITHOUT NOTICE. RETURNED ORDERS ARE SUBJECT TO A RESTOCKING FEE. INTERNATIONAL CUSTOMERS PAY ALL SHIPPING CHARGES. ALL SHIPPING CHARGES ARE NON-REFUNDABLE. TO RETURN MERCHANDISE CALL FOR AN RMA NUMBER. ALL RMAs MUST BE RETURNED WITHIN 30 BUSINESS DAYS OF ISSUANCE. CUSTOMERS ARE RESPONSIBLE FOR SHIPPING CHARGES TO RETURN PRODUCT.





# The LLB Company, Inc.

## 1-800-848-8967



Email: sales@llb.com International:425.746.0229 Fax:425.746.5168

### DESKTOP MEMORY UPGRADES

#### 168-Pin 60ns DIMMs

PowerMac Series - 60ns		
Module	Item#	Price
128MB	12864	\$748
64MB	64764	\$199
32MB	32764	\$102
16/8MB	16764	\$55/36

#### EDO 3.3v 60ns DIMMs

Starmax & PowerM 4400		
Module	Item#	Price
64MB	64764EDO3.3	\$247
32MB	32764EDO3.3	\$112
16MB	16764EDO3.3	\$77
8MB	8764EDO3.3	\$46

#### EDO 5v 60ns DIMMs

Power Base Series		
Module	Item#	Price
64MB	64764EDO5V	\$205
32MB	32764EDO5V	\$114
16MB	16764EDO5V	\$59
8MB	8764EDO5V	\$55

#### 72-Pin SIMMs

PowerMac 6100...		
Module	Item#	Price
32MB	32632	\$98
16MB	16732	\$48
8MB	8032	\$30
4MB	4032	\$21

#### 30-Pin SIMMs

Mac Ili, si, se, IliX...		
Module	Item#	Price
16MB	1601	\$103
8MB	8888	\$50
4MB	4000	\$18
2MB	2000	\$12

### POWERBOOK MEMORY UPGRADES

#### POWERBOOK 2400

Module	Item#	Price
64MB	PB2400-64	\$382
32MB	PB2400-32	\$186
16MB	PB2400-16	\$93
8MB	PB2400-8	\$62

#### POWERBOOK 2300

Module	Item#	Price
48MB	PB2300-48	\$288
36MB	PB2300-36	\$250
20MB	PB2300-20	\$162
16MB	PB2300-16	\$118

#### POWERBOOK 3400

Module	Item#	Price
128MB	PB3400-128	\$662
96MB	PB3400-96	\$620
64MB	PB3400-64	\$320
32MB	PB3400-32	\$151
24MB	PB3400-24	\$145

#### POWERBOOK DUO

Module	Item#	Price
36MB	PBDUO-36	\$250
28MB	PBDUO-28	\$239
20MB	PBDUO-20	\$139
14MB	PBDUO-14	\$115
12MB	PBDUO-12	\$109

#### POWERBOOK 5300

Module	Item#	Price
48MB	PB5300-48	\$284
32MB	PB5300-32	\$182
16MB	PB5300-16	\$104
8MB	PB5300-8	\$65

#### POWERBOOK 1400

Module	Item#	Price
24MB	PB1400-24	\$159
16MB	PB1400-16	\$101
8MB	PB1400-8	\$60

#### POWERBOOK 500

Module	Item#	Price
32MB	PB500-32	\$146
16MB	PB500-16	\$80
8MB	PB500-8	\$72
4MB	PB500-4	\$62

#### POWERBOOK 150

Module	Item#	Price
28MB	PB150-28	\$218
20MB	PB150-20	\$160
8MB	PB150-8	\$70
4MB	PB150-4	\$45

### PRINTERS & SCANNERS



**UMAX**  
Computer Corporation

**\$299**

Astra 600 \$179  
Astra 1200 w/Full PS & Trans \$650

### EPSON

Stylus 600 Inkjet  
**\$319**



Stylus 800 Inkjet \$399  
Expression 636 Executive \$805  
Stylus Color 1520 \$807  
Stylus Color 3000 \$1922



Laserjet 4MV 600 DPI \$2795  
Laserjet 6MP 600 DPI \$927

### MODEMS



GLOBAL VILLAGE COMMUNICATION  
**As Low As \$159**

Teleport 56 K56 Flex Ext \$159  
Teleport 56K X2 Ext \$388  
Powerport 56k PCMCIA/Enet \$183

### DIAMOND

SUPRA Express 56e K56 Flex Sp \$195  
SUPRA Express 56e K56 Flex Ext \$166  
SUPRA Express v.34 Ext 14.4 S/R \$72



Sportster 56K X2 Ext Fax \$211  
Sportster 33.6 Ext w/voice(14.4 Fax) \$99  
Sportster 56K XJack PCMCIA \$249

### MONITORS

**HOT!**

NEC  
NEC A500 15" Multisync \$329  
NEC A700 17" Multisync \$677  
NEC E500 15" Multisync \$404

SONY  
SO 200SF 17" Multiscan \$799  
SO 300SFt 20" Triniton \$1618  
ViewSonic  
VS 15VGA 15" Optique \$277  
VS 17GS 17" 17GS \$583

### UMAX SUPERMAC SYSTEMS

SuperMac	Processor/Speed	Price
UCC 500L-200LT	603E 200MHz (LT)	\$997
UCC 600L-240LT	603E 240MHz (LT)	\$1397
UCC 600L-200	603E 200MHz	\$1076
UCJ 700L-180	603E 180MHz	\$1775
UCJ 700L-233	604E 233MHz	\$1945
UCS 900L-200	604E 200MHz	\$2492
UCS 910E-250	604E 250MHz (E)	\$4246
UCS 910E-250D	604E 250MHz (DP)	\$6759

### DRIVES

#### LACIE

Q 2.1 GB (Int) 5400RPM \$275  
Q 2.1 GB (Ext) 5400RPM \$374  
Q 4.3 GB (Ext) 5400RPM \$713  
Q 6.4 GB (Ext) 7200RPM \$634  
Q 9.1 GB (Ext) 7200RPM \$1149  
LaCie 24X Ext CD-Rom Drive \$199

**Jaz Drive**  
with 1 Free Disk  
**\$399**



Zip Drive w/Disk \$149

**newertech**  
**MAXPOWR PRO**  
**\$1248**



**NETCOM**  
1 MONTH OF FREE INTERNET SERVICE & \$40 WORTH OF CD-ROM SOFTWARE ONLY  
**\$1.99**  
WITH ANY LLB PURCHASE



**POWER3D**  
The New Exciting Graphics Accelerator from TechWorks  
**\$199**

- Perspective-corrected texture mapping
- Bi-linear and advanced texture filtering
- Gouraud shading and texture modulation
- Anti-aliasing and alpha blending
- Special effects: fog, transparency and translucency



1-800-848-8967

Electronic Orders: E-Mail:sales@llb.com · Web Site: Under Reconstruction...Please bear with us.... · PO's are accepted upon approval

· All major credit cards accepted and charged when order is shipped · No surcharge on credit cards · Prices subject to change

· Open 6am to 7pm M-F, 8am to 1pm Sat.PST · Returns subject to restocking fee · Not responsible for errors · We welcome International orders

· Orders received before 8:00p.m. EST weekdays shipped same day



**PRODUCT INDEX**

Category	Page No.	Category	Page No.
<b>Business Operations</b> . . . . .	<b>164-165</b>	<b>Peripheral Products</b> . . . . .	<b>168-169</b>
Bar Code		Cross Platform	
Inventory Management		Magnetic Media	
Print Utility		Security Systems	
Video/Display		Software Publishing	
<b>Communications/</b>		<b>Services</b> . . . . .	<b>193-194</b>
<b>Networking</b> . . . . .	<b>169</b>	Color Printing	
Cross Platform		Data Recovery	
<b>Education/</b>		Digital Production	
<b>Entertainment</b> . . . . .	<b>165-167</b>	Repair	
Discount Software		<b>Systems &amp; Peripherals</b> . . .	<b>169-188</b>
Music		<b>Account Managers</b> . . .	<b>800.825.4237</b>
<b>Memory &amp; Upgrades</b> . . . . .	<b>189-193</b>	Lisala Beatty . . . . .	212.503.5153
Memory Upgrade		lbeatty@zd.com	
<b>Digital Advertising Coordinator:</b>		Eric Birnbaum . . . . .	212.503.5043
Brian Mullin . . . . .	415.267.1735	ebirnba@zd.com	
brian_mullin@macworld.com		Monifa Kelly . . . . .	212.503.5155
		mkelly@zd.com	
		Michelle LeWinter . . . . .	212.503.5122
		mlewinte@zd.com	
		Jessica Turko . . . . .	212.503.5140
		jturko@zd.com	
		<b>Sales Manager:</b>	
		Tom Foran . . . . .	212.503.5145
		thomas_foran@zd.com	

**IF WE DON'T SELL IT, IT'S NOT WORTH LOOKING AT.**



**PANELIGHT IS YOUR ONE STOP SHOP FOR ALL LEADING BRANDS SALES, RENTALS, & LEASES • MONEY BACK GUARANTEE.**

**TRUSTWORTHY TECHNICAL GUIDANCE AND SUPPORT**

**QUICK DELIVERY**

**MONEY-BACK GUARANTEE**

- Epson
- CTX
- nView
- In Focus

**CALL PANELIGHT FOR OUR FREE CATALOG: 1-800-726-3599.**

MON.-FRI., 6:30AM-5:30PM P.S.T.  
24-HR. FAX: 415-986-3817  
OR E-MAIL: SALES@PANELIGHT.COM  
[HTTP://WWW.PANELIGHT.COM](http://WWW.PANELIGHT.COM)

PANELIGHT DISPLAY SYSTEMS, INC.,  
P.O. BOX 190940,  
SAN FRANCISCO, CA 94119.  
OR CALL 415-772-5800.

**TREMENDOUS SELECTION OF ALL LEADING PROJECTORS**

**SALES, LEASES OR RENTALS**

**DISCOUNT PRICES**

- Toshiba
- Polaroid
- Proxima
- Panasonic



**CALL THE EXPERTS AT PANELIGHT DISPLAY SYSTEMS, INC.**

CIRCLE 441 ON READER SERVICE CARD

**Bar Code Pro<sup>®</sup> v3.5 with Veribar<sup>™</sup>**



Create perfect PostScript (EPS) bar code graphics for Quark, PageMaker, Illus., etc.

Bar Code Pro<sup>®</sup> features:

- ✓ All popular bar code symbologies
  - ✓ Any printer resolution! No fonts required.
  - ✓ No prior bar code experience necessary.
  - ✓ No more bar code film masters.
  - ✓ Veribar built-in verification (optional).
  - ✓ Pays for itself in a single use.
- "Takes sixty seconds to install, five minutes to master!" — MacWorld

**CALL FOR FREE DEMO**

**SNX** [www.snx.com](http://www.snx.com) Tel: (800) 619-0299 Fax: (718) 768-3997  
(formerly SYNEX)

CIRCLE 444 ON READER SERVICE CARD

**Newton<sup>®</sup> Joins the Mac-Barcode<sup>®</sup> Family!**

One Stop Shopping with Friendly Support from the Experts



**Newton<sup>®</sup> Walk-About<sup>™</sup> Mac-Barcode ProLabel Software**  
SmartLaser/SmartScanner/SmartPen Thermal Transfer Printer  
Call for Literature & Free Demo Disk

The Mac-Barcode Co.  
**800-733-7592**  
<http://www.mac-barcode.com>

CIRCLE 442 ON READER SERVICE CARD

**Software Blowout!!!**  
**Tel: 1-800-785-0048**

<b>Microsoft</b>	
MS Office 4.21 (Word, Excel, Powerpt)	\$199
MS Word 5.0/6.0.1	\$75/125
MS Excel 5/Powerpoint 4	\$150
Front Page	\$75
MS Project 4.0	\$250
MS Office Win 97	\$295
<b>Adobe</b>	
Photoshop 4.0	\$335
Pagemaker 6.5	\$275
Illustrator 7.0	\$215
Premier 4.2	\$335
After Effects/Studio Bundle	\$335/1180
Framemaker 5	\$335

<b>Macromedia</b>	
Freehand 7.0/VectorEffects	\$215
Freehand Graphic Studio	\$299
SoundEdit 16 Deck II	\$275
Fractal Design Painter 4.0	\$235
Call for Corel, Claris, Caere, Metatools, Strata, Specular, Symantec, and Denaba products.	

**SUPER SOFTWARE**  
800-258-0297(FAX) 800-260-3988  
Call 9AM to 6PM PST Since 1983

**Bar Code Headquarters**



- Portable Batch Readers
- Cordless Interactive RF Bar Code Readers
- ADB Bar Code Readers
- Wand, Laser, CCD, Magstripe or Slot Badge
- PostScript Bar Code Fonts



**WORTHINGTON DATA SOLUTIONS**  
**1-800-345-4220**  
Or Call 408-458-9938  
Website: [www.barcodehq.com](http://www.barcodehq.com)

See us at Fall Comdex Booth #H1242

**POINT OF SALE INVENTORY CONTROL**

- Retail
- Rentals
- Service
- Manufacturing
- Multi Location

Bar Code/Magnetic Stripe Readers  
Receipt Printers • Cash Drawers  
Credit Card Auth. & Depositive Software  
Download Demos and Interactive Catalog at our Web Site: <http://www.posdirect.com>  
call, fax, or e-mail for a **FREE CATALOG**  
(800) 622-7670 sales@posdirect.com  
(618) 985-8237 TEL • (618) 985-3014 FAX  
Dealer Inquiries Welcome  
30 day MBG

CIRCLE 442 ON READER SERVICE CARD



# BAR CODE SOLUTIONS

- LABELING SOFTWARE
- BAR CODE FONTS
- SCANNERS/LASERS
- GRAPHIC UTILITIES

FREE EXPERT CONSULTATION  
FREE LIFETIME TECHNICAL SUPPORT  
MONEY-BACK GUARANTEE

UPC/EAN, CODE 39, ITF, POSTNET, 2-D

International Bar Code Expertise  
300,000 Customers Worldwide

**Bear Rock TECHNOLOGIES**

**800-232-7625**  
916-672-0244 FAX: 916-672-1103

"This is the best product of it's kind, and it's reasonably priced too."  
-MacUser on Printer For Macintosh

Visit Our Website At:  
**www.bearrock.com**

CIRCLE 443 ON READER SERVICE CARD

## Now...the official printing system of Santa!

Print for the serialMac data printing... using good to create greeting cards, in... (Screenshot of print utility interface)

Use our automatic booklet maker, or design your own and watch as your application adjusts to the new mini-paper size!

Toner control at the page or object level!  
Paper thickness control for proper booklets  
Head-to-toe & reversed printing

Automatic miniature, simply choose a layout  
Paper control that you wouldn't believe possible

"This simple extension has more printing power than most applications..." *Santa's Helper*

To boost the printing power of any application, call **(800) 648-6840** or try our demo at **www.mindgate.com**

**printChef**  
Introductory priced at \$45  
...so that everyone can make their printer sizzle right now!

60-day money-back guarantee

List Price: Base unit \$95  
Net: \$15-\$25/unit  
Worldwide: (931) 937-6800  
Fax Orders: (931) 937-6801

Order Direct: VISA, MasterCard, Discover, American Express, or thru MacWorld 800-255-6227

System 7+ required! For 680x0 & any PowerMac. Works with ANY printer & ANY application. printChef's miracles require only 32K of memory. QuickDraw GX is NOT required.

MindGate, printChef & its logos are registered trademarks. Fill-in-the-Blank is a trademark, & "It's not printing magic... it's printing science!" is a trademark of MindGate Technologies.

CIRCLE 440 ON READER SERVICE CARD

www.macworld.com/buyers/shframed.htm

## Mac shopper

Want bargains online?  
Bookmark the Mac Shopper at:

**Macworld Online**

Contact Macworld on how to advertise.  
**(800) 888-8622**

## MUSIC for the MAC

We sell the full range of music products for the Mac. Hard Disk Recording Specialists.

Best prices & customer support in the business!

**Mac BEAT!** **www.macbeat.com**  
FREE CATALOG ☎ 505-473-3434  
1314 Rufina Cr. Ste. #A4 Santa Fe, NM. 87505 Fax 505-473-4647  
**1-800-MAC-BEAT**

"A Macworld never goes by without me checking to compare prices. I always look to see if what I need is there."  
-Owner, Computer Consultants

**Macworld SHOPPER**

## STUDENTS, TEACHERS, SCHOOLS SAVE UP TO 80%

**Image** EDU-SOFT

**We'll Beat ANY Advertised Price!!!** Adobe, Microsoft, Lotus, & Borland products available.

**199.00** Macromedia FreeHand 7 Graphics Studio

Macromedia FreeHand 7 .149

3D Web Workshop . . . . . 99	FileMaker Pro 4.0 . . . . . 119	MiniCAD 7 . . . . . 319
4th Dimension 6.0 . . . . . 249	Final Draft 4.1 . . . . . 119	NetObjects Fusion 2.0 . . . . . 149
Authorware 4.0 . . . . . 749	Finale 97 . . . . . 249	Nisus Writer 5.0.1 . . . . . 85
Canvas 5.0.2 . . . . . 169	Fractal 3D Suite 2.0 . . . . . 299	OmniPage Pro 7.0 . . . . . 329
Claris HomePage 2.0 . . . . . 59	Fractal Dabbler 2.0 . . . . . 39	PageTools 2.0 . . . . . 69
Claris Works 5.0 . . . . . 79	Fractal Detailer 1.0 . . . . . 129	QuickKeys 3.5.2 . . . . . 85
Cliff Notes Studyware . . . . . 39	Fractal Expression . . . . . 99	QX-Tools 2.0 . . . . . 69
CodeWarrior Pro 1.0 . . . . . 119	Fractal Painter 5.0 . . . . . 209	Ray Dream Studio 5.0 . . . . . 119
Collage 2.0 . . . . . 59	Fractal Poser 2.0 . . . . . 79	Ray Dream 3D . . . . . 69
Conflict Catcher 4.0 . . . . . 59	Infini-D 4.0 . . . . . 329	Softwindows 95 4.0 . . . . . 199
CorelDRAW Ste 6.0 . . . . . 139	omega ZIP Drive . . . . . 149	Strata Media Paint 1.x . . . . . 179
Debabelizer Toolbox . . . . . 229	Kai's PhotoSnap . . . . . 49	Strata Studio Pro 2.1 . . . . . 549
Director 6 w/E-Doc . . . . . 329	Kai's Power Tools 3.0 . . . . . 85	SuperCard 3.0 . . . . . 129
Director MMS 6 . . . . . 679	Kodak DC120 ZOOM . . . . . 779	Total Xaos Bundle . . . . . 129
Director MMS Upgd . . . . . 399	KPT Bryce 2.0 . . . . . 119	Umax Astra 600S . . . . . 209
Electric Image Broadcast . . . . . 1349	KPT Vector Effects . . . . . 85	Wacom ArtPad 4x5 . . . . . 129
Encore 4.2 . . . . . 249	LightWave 3D 5.5 . . . . . 799	Wacom ArtZ II 6x8 . . . . . 265
EndNote Plus 2.x Stu. . . . . 99	Logomotion 2.1 . . . . . 39	Wacom ArtZ II 12x12 . . . . . 399
Epson Stylus 800 . . . . . 399	Mac OS 8.0 . . . . . 85	Web Graphics Studio . . . . . 79
Eye Candy . . . . . 79	Mathematica . . . . . 149	WordPerfect 3.5.1 . . . . . 39

WebSite **www.ElectronicImage.com** • Fax (510) 798-2464 • FREE Catalog

**TOLL FREE 1-888-EDU-SOFT**

CIRCLE 447 ON READER SERVICE CARD



# Student - Teacher - School Discounts!

WE WILL BEAT ANY ADVERTISED PRICE \* LATEST VERSION & FULL PACKAGES

18 Perfect People 1.0	\$199
3D AcuWorlds Models	\$79
3D Dizzy 1.0	\$69
3D HotText 1.0	\$99
3D Words 1.0	\$69
4th Dimension 6.0	\$249
Adam Comprehensive Student ED	\$99
Agfa SnapScan	\$279
Alias Sketch! 2.0.2	\$199
Amapi 3.0	\$249
Anubis Utility	\$49
ArchCad 5.0 Student	\$129
Astound 3.0	\$99
Astra 600S Scanner PhotoDeluxe	\$209
Authorware 4.0	\$749
Authorware Studio 4.0	\$2649
AutoCAD R12 w/Ame	\$199
BBEdit 4.5	\$79
Berserk 1.3	\$159
Bitstream Collection	\$129
Boris FX Limited 3.0	\$129
Canvas 5.0.2	\$179
ChemOffice Pro 4.0	\$299
Claris Draw 1.0	\$119
Class Action	\$65
Classic PIO Partners	CALL
ClearVideo 1.2	\$229
Cliff Notes StudyWare Geometry	\$25
Coda 1.0	\$249
Coda Finale 97	\$249
ColorDrive 1.5.3	\$89
Conflict Catcher 4.0	\$59
CorelDRAW Suite 6	\$169
Cricket Graph III 1.5.3	\$79
Cubase Audio XT/VST 3.5	\$399
Cubase VST 3.5	\$199
Cyclonist 1.0	\$249
Dabbler 2.0	\$39
DeBabelizer Toolbox 1.6.5	\$229
DeltaGraph 4.0	\$89
DesignWorkshop 1.7	\$199
Detailer 1.0	\$129
Digital Box Office	\$249
Director 6 Studio	\$679
DrawingSlate II 12x12	\$299
EPS Invigorator 1.5	\$249
Encore 4.1.1	\$249
EndNote Plus 2.2 w/EndLink	\$165
Epson Expression 636-Executive	\$769
Epson Stylus 600 InkJet Printer	\$289
Epson Stylus Color 3000 InkJet Print	\$1929
Epson Stylus Photo InkJet Printer	\$475
Eudora Pro 3.1	\$49
Expression 1.0	\$99
FastTrack Schedule 5.0	\$139
FileGuard 3.0	\$119
FileMaker Pro 4.0	\$139
Final Draft 4.1	\$149
Flash 2.0	\$149
Flo! 2.6.3	\$69
Form Z 2.92	CALL
FreeHand 7.0	\$149
Globalink 4In1 Power Translator 6.0	\$129
Hercules Animated StoryBook	\$39
Hollywood FX 3.0	\$359
HomePage 2.0	\$69
HyperCard 2.3.5	\$89
HyperStudio 3.1	\$119
Illuminaire Paint	\$749
Illuminaire Studio	\$1299
ImageAXS	\$59
Inspiration 5.0	\$79
Intelligence 3.0	\$69
Omega Jaz 1GB Ext Drive Ma/PC	\$389
Japanese Language Kit 1.2	\$129
Java Beat	\$75
Jmp 3.2	\$329
Judson-Rosebush Wildside Bundle 5	\$149
KPT Bryce 2.0 Kit	\$49
KPT Final Effects 3.0	\$399
KPT Final Effects AP 1.0	\$109
Kai's Photo Soap 1.0	\$39
Kai's Power Goo 1.0	\$39
Kai's Power Tools 3.0.2	\$85
KaleidaGraph 3.0	\$109

**\$599**

**Photo Design**

**Illustration**

**Page Layout**

Market-Leading Page Layout software  
Market-Leading Illustration software  
Market-Leading Photo Design software

From the world's leading desktop publishing software manufacturer... 3 market leading DTP Tools

**DeskTop Publishing Bundle**

**\$229**

**Boris FX Limited 3.0**

Plug-In for Adobe Premiere

**NEW!**

**\$79**

**Chromatica**

Photoshop Plug-In

**199**

**Dramatica Pro 2.0**

ScreenPlay Writing

**NEW!**

**\$89**

**ClarisWorks 5.0**

All Around Office Program

**\$49**

**Virex 5.7**

Anti-Virus Program

**\$159**

**Aurorix 2**

Plug-In for After Effects

**NEW!**

**\$179**

**CyberStudio 2.0**

BestWay to Build Web Sites

**\$549**

**MTropolis 1.1**

Authoring Program

**\$129**

**CodeWarrior Pro**

C/C++ Programming

**NEW!**

**\$85**

**Mac OS 8**

System 8.0

System Software for the Macintosh

**NEW!**

**\$329**

**Infini-D 4.0**

3D Modeling & Animation

**\$69**

**PhotoTools 1.1**

Photoshop Plug-In

**Call for FREE Catalog!**

**(800) 831-2295**

Includes Complete Price List & Free Product Info.

- \*\*SAME DAY SHIPPING ON MOST ITEMS.
- \*\*ADOBE, SYMBIANTIC & MICROSOFT PRODUCTS AVAILABLE TO QUALIFIED STUDENTS, TEACHERS & SCHOOLS.
- \*\*SCHOOL PURCHASE ORDERS WELCOME.
- \*\*NO SURCHARGE ON CREDIT CARDS.
- \*\*IBM & MAC PRODUCTS AVAILABLE.

Visit our **NEW** Web Site!!  
<http://www.swsonline.com>

\*Not responsible for typographical errors.  
\*\*Prices subject to change.  
\*\*\*The Software Searcher has the right to withdraw any order.



**1-800-831-2295**

1750 Brielle Ave, Unit A-2  
Ocean, NJ 07712  
PHONE (732) 695-2100  
FAX (732) 695-9371  
E-MAIL: SFTSWS@AOL.COM



# Student - Teacher - School Discounts!

WE WILL BEAT ANY ADVERTISED PRICE \* LATEST VERSION & FULL PACKAGES



**\$479**

**Artist's Dream Bundle**  
Wacom Art Z II 6x8 & Painter 5.0



**\$419**

**Epson Stylus 800**  
Color Inkjet  
High performance  
1440x720 dpi Printing



**\$119**

**Bryce 2**  
3D Terrain Program

**Your Career In 3D Animation Begins Here**

**\$1349**

**ElectricImage BROADCAST**  
Hi-Speed Rendering

**NEW**



**\$349**

**Director 6 E-Doc**  
Director 6 with Online Documentation



**\$79**

**Eye Candy 3.0.1**  
Photoshop Plug-in that contains several filters



**\$199**

**Freehand Graphics Studio**  
Includes FreeHand 7, Fontographer, Extreme 3d, and xRES



**\$149**

**NetObjects Fusion 2**  
Smart Way to Build Web Sites



**\$339**

**MiniCad 7.0**  
2D/3D Cad Software



**\$299**

**Fractal 3D Suite**  
Includes Ray Dream Studio, Bryce 2, Poser 2 & Detailer



**\$149**

**Iomega Zip 100 External Drive**  
Expand your Hard Drive Without Limits!

**NEW!**



**\$109**

**Retrospect 4**  
Backup Software



**CALL**

**LightWave 3D 5.5**  
Modeling & Animation

**Call for FREE Catalog!**  
**(800) 831-2295**  
Includes Complete Price List & Free Product Info.

**\*\*SAME DAY SHIPPING ON MOST ITEMS.**  
**\*\*ADOBE, SYMANTEC & MICROSOFT PRODUCTS AVAILABLE TO QUALIFIED STUDENTS, TEACHERS & SCHOOLS.**  
**\*\*SCHOOL PURCHASE ORDERS WELCOME.**  
**\*\*NO SURCHARGE ON CREDIT CARDS.**  
**\*\*IBM & MAC PRODUCTS AVAILABLE.**

Visit our **NEW** Web Site!!  
<http://www.swsonline.com>

Kidpix Studio	\$35
Kodak DC50 Digital Camera	\$649
Life Forms 2.1	\$199
Live Picture 2.6	\$199
Logic 2.6	\$229
M.Y.O.B 7.0	\$49
M.Y.O.B 7.0 w/Payroll	\$90
Mac Academy Tutorial Video	\$35
MacLink+ Translator Pro 9.7	\$95
Mad Scientist Collect	\$79
MagicMask	\$79
Mask Pro 1.0	\$199
MathType 3.5	\$99
Mathematica 3.0 Student	\$149
Matlab 5.0 Student	\$99
Mavis Teaches Typing 5.0	\$45
Media Cleaner Pro 2.0	\$249
MediaPaint 1.2	\$179
MeshPoint 3D 1.6	\$315
Mosaic 1.5	\$249
Movie Magic Scheduling	\$329
MovieFlo+ 2.0.4	\$369
MovieWorks Interactive 4.0	\$79
Myrmidon 1.2	\$35
Netscape Communicator 4.0.1	\$29
Netscape Communicator Pro 4.0.1	\$49
Nisus Writer 5.0.1	\$85
Now Bundle 3.6.5	\$69
Now Utilities 6.7	\$55
ObjectDancer 1.0	\$199
OmniForm 2.0	\$129
OmniPage Pro 7.0	\$329
Orbit Trackball	\$69
Overture 2.0.2	\$249
Paint Alchemy 2.0	\$79
Painter 5.0	\$219
Photo/Graphic Edges	CALL
PhotoVista	\$79
Pixar Showplace	\$139
Portfolio 3.0	\$69
Poser 2.0	\$79
PosterWorks 4.0	\$249
Presenter 3D 3.6	\$995
Printshop Dix Ensemble Mac CD	\$60
Quickeys 3.5.2	\$85
Ram Doubler 2.0	\$55
Ray Dream Studio 5.0	\$129
RubberBall Faces	\$199
SPSS 6.1 Student	\$99
Screen Caffeine Pro	\$75
Sculpt 3D 4.2	\$219
SoftWindows 95 4.0	\$199
SoundEdit 16+ Deck II	\$249
Speed Doubler 8	\$55
Spell Catcher 1.5	\$49
Sportster 56K Ext	\$209
Spring Cleaning 1.0.1	\$49
Squizz! 2.0	\$69
Storyboard Artist 1.5	\$329
Studio Effects 1.0	\$399
Studio VisionPro 3.5.4	CALL
StudioPro 2.1	\$549
Stuffit Deluxe 4.0	\$69
Stylist 1.0	\$85
SuperCard 3.0	\$129
SupraExpress 56K Ext	\$189
Terra Forma Regional 1,2 OR 3	\$129
Terrazzo 2.0 w/TubeTime	\$79
Textissimo 1.0	\$69
The Teacher's Tool Kit	\$69
Total Xaos	\$129
Trackman Marble	\$85
Tree EIAS Storm w/Tree Painter	\$449
TypeCaster	\$79
TypeShop Pro	\$129
Video/Graphic Edges 3.0	CALL
Video/Graphic Edges	CALL
Virtual PC	\$149
Wacom Art Z II 12x12 Ser Tablet	\$399
Wacom Art Z II 6x8 Adb Tablet	\$285
Wacom ArtPad II 4x5 Adb Tablet	\$129
Walkthrough Pro 2.6	\$229
WebPage Graphics	\$69
WebPainter 2.0	CALL
WildRiversSK 1.0	\$85
WordPerfect 3.5.1	\$69

**The SOFTWARE Source**

**1-800-831-2295**

1750 Brielle Ave, Unit A-2  
Ocean, NJ 07712  
PHONE (732) 695-2100  
FAX (732) 695-9371  
E-MAIL: SFTSWS@AOL.COM

**Priority Code: 3086**



## Secure Only The Computers You Want To Keep!

Secure-It, Inc. is a leader in computer security, having the highest quality and the largest selection of products to suit your needs. Our computer security staff is ready to assist you in solving your problem to minimize your risk. They can suggest an existing package, or assemble a special package just for you.

- Secure your:**
- Notebooks
  - Desktops
  - Peripherals
  - Internal Boards
  - Disk Drives
  - CD Roms
  - Etc.

For a **FREE** consultation, or a **FREE** catalog...  
Call Today!  
**800-451-7592 Dept. SE**



18 Maple Court, East Longmeadow, MA 01028, USA Phone: 413-525-7039 Fax: 413-525-8807  
Dealer inquiries invited • Mastercard accepted

CIRCLE 409 ON READER SERVICE CARD

for Mac & PC **We really make sense**

Complete lines of networking products: PCI, NuBus, PCMCIA/ Card bus & PDS network cards; Transceivers, Hubs, LAN Switches, Cable testers. Internet devices: Internet Sharing Hubs, ISDN Modems & Routers. Peripherals: SCSI Terminators & Game Controllers.

PCMCIA



FastEthernet Cards

FastEthernet Hubs, Switches.....



FunPad & FunStick



Distributor & reseller inquires welcome

Visit us at **Macworld Expo-SF, North Hall booth#4456**

Please call or email for **FREE** product catalog



Just Macsense Technology Inc.

Tel: 1-800-642-8860 Fax: 408-744-1060  
1290 Reamwood Ave. #B Sunnyvale, CA 94089  
www.macsensetech.com

**NEW YEARS SPECIAL!**  
Finally - A gift for you!

**MITSUI** Recordable  
**GOLD** CD-Rom media.

The best CD-R's in the world, backed by the only lifetime warranty in the business and isn't it time to buy a gift for **yourself** anyway?

**NEW YEARS SPECIALS**

- 10-disc sample pack \$24.99
- 100-disc case \$199.99

CALL AMC TODAY before these specials vanish as fast as 1997 did!



**888-558-3186**  
or fax: (425) 861-8391

## EXPERIENCE THE AMC QUALITY DIFFERENCE.

AMC. QUALITY. INTEGRITY. EXPERIENCE.

**AFFEX HARDCOPY COLOR INK JET PRINTER**

Call today for:

**Best Price!**

**ALL NEW!**  
AFFEX

The CD-4004 offers all the features of large scale CD-R duplicators at a fraction of the price.

Prices start at:

**\$499.**

**PLASMON CDR480**

The CDR480 is a quad speed (4x) recorder + an 8x CD-ROM reader that is compatible with all standard CD recording formats.



**AMC** Experience the Difference.

**ADVANCED MULTIMEDIA CONCEPTS**

P.O. Box 3456 Redmond, Washington 98073-3456 • 888-616-4589 www.mwm.amc-direct.com

**MediaFORM CD-ROM DUPLICATOR**

The cost effective CD printer. Print's CD's, Jewelcase liners and other media in brilliant 1440dpi color.

Prices start at:

**\$799.**

**AMC 2-HI JAZZ/CD-R COMBO**

The ultimate CD-ROM Mastering solution. Custom-built to your specifications with 2x6 or 4x6 CD-R drives, Jaz and/or A/V Hard Drives. All kits include Adaptec Toast Mastering software.

Prices start at:  
**\$2649.**



Ad Code  
MW21C

CIRCLE 408 ON READER SERVICE CARD



## Finally! Windows 95 and Macs Share Files and Printers Both Ways

Workgroups and small offices can now operate as efficiently as an enterprise with **PC MACLAN for Windows 95**. Low cost, plug and play installation, Network Neighborhood and long file name support, are just a few of the features that make sharing files, volumes and printers between Macs and PCs a snap.

"For peer-to-peer networking...  
**PC MACLAN 6.0 is the only choice.**"

— Macworld - Nov. '96

Create your own network or complement almost any pre-existing LAN. Sharing information between Windows 95 and Macintosh users is as easy as working off your local hard drive. Print jobs go to the printer of your choice regardless of its location on the network.

For ordering or information:  
**800-862-2526**

e-mail: [sales@miramarsys.com](mailto:sales@miramarsys.com)

Web: [www.miramarsys.com](http://www.miramarsys.com)

Please visit us at these upcoming shows:  
Seybold Seminars Oct. 1-3 — Booth # 2428  
CUE Conference Oct. 16-18 — Booth # 902



NOVEMBER 1996  
Macworld  
★★★★ 75



CIRCLE 446 ON READER SERVICE CARD

### Warehouse Clearance!

All Products in working condition



Take 15%-45%  
Off listed prices  
- Cash sales only -

### Power Computing 120

PPC 601 @ 120 MHz  
3 x 7" NuBus Slots  
Built-in Video & Ethernet  
Kybd., Mouse, Software Pkg.

From **\$399**

### Mac SE & Mac Plus

\*AS-IS, good working condition.  
Keyboard and mouse additional.  
Ram & Hard Drive Additional.  
(May contain cosmetic defects)

From **\$49**

## BIG Discounts-Year End Clearance

[All Products sold in \*\*AS-IS\*\* condition.]

<b>Mac II (CPU ONLY)</b>	From <b>\$49</b>	<b>Powerbook 140</b>	From <b>\$299</b>
<b>Mac IICX</b>	From <b>\$149</b>	<b>Powerbook 170</b>	From <b>\$399</b>
Mac LC	From \$139	HP Scanners	From \$99
Mac IISI	From \$199	QMS Laser Printers	From \$199
Quadra 605	From \$329	QMS Ram Upgrades	From \$29
Centris 610	From \$399	PowerMac AV Card	\$179
Quadra 630	From \$399	Power Computing Video Cards	\$79
Centris 650	From \$399	Powerbook Batt Recharger Base	\$29
Quadra 650	From \$449	Extended Keyboards	\$39
Quadra 660AV	From \$499	Apple 1.44mb Floppy Disks	\$5
Quadra 700	From \$449	Apple 8 • 24GC Video Cards	\$149
PB Duo 270c	From \$599	Powerbook Modems 2400 baud	\$25
WGS 80	From \$599	Comm Slot Modems	\$10
WGS 95	From \$999	Nubus Ethernet Cards	\$25
Apple 13" RGB	\$199	SE or SE/30 Ethernet Cards	\$25
Apple 14" Color Display	\$199	Pers. LaserWriter SC/NT → NTR Upgrade	\$59
Apple 14" Color Plus	\$199	Ethernet Transceivers	\$39
Apple 14" /w Touch Screen	\$229	Microsoft Works	\$10
Apple 15" MultiScan	\$299	Microsoft Word Upgrade	\$15
Apple 16" Color Display	\$399	Click Art CD	\$10
Apple 1710AV Display	\$599	Video Cards	From \$49
LaserWriter 300	\$229	Plastic CPU Cases	From \$15
LaserWriter 310	\$299	Software Bundles	\$10
LaserWriter IIf Upgrade	\$299	Large Selection of Parts	CLOSE-OUT
LaserWriter Engines	\$199		

\*Call for one of a kind items\*

Limited Time & Quantity / Prices and stock subject to change / No Refunds / Dealers welcome  
\*As is\* products are working, may be repaired / replaced within 14 days of purchase only, at Mgmt. discretion.

1150 W. Alameda Dr., Ste. #1  
Tempe, AZ 85282

**1-800-729-7031**

FAX: 602-858-0811  
[www.macsaleint.com](http://www.macsaleint.com)

CIRCLE 425 ON READER SERVICE CARD

# CD-R

\$1.99

100 Pc. Minimum  
w/jewel Case

# SONY

4x/6x  
CD Recordable Internal

# \$449

jaz \$82.95

MEDIA SUPPLY

[www.mediasupply.com](http://www.mediasupply.com)

**800-944-4237**

610-458-9100 • Fax: 610-458-9464

CIRCLE 445 ON READER SERVICE CARD

## COMPUTER REVELATIONS

NEW & USED BOUGHT & SOLD  
USED LASERWRITER IINT \$199

POWERMAC	
7300/180	\$1899
7300/200	\$2299
8600/200/300	CALL
9600/200/300/350	CALL
7200/7600/8500/9500/	CALL
PRINTERS	
LWRITER 12/640	CALL
LWRITER 4/600	\$889
HP 6MP	CALL
HP 1600 C/PS	CALL
HP 4MV	\$2699
STYLEWRITER 1500/2500	CALL
POWERBOOK	
3400	CALL
1400	\$2299
1400C/117	CALL
1400C/133	CALL
UMAX / SUPERMAC	
S90L	CALL
S900D	CALL
SCANNERS	
VISTA/S6E SOHO	\$279
POWERLOOK II	\$1829
EXPRESSION 636	\$1389
AFGA SNAPSCAN	\$329
AFGA ARCUS II	\$1589
MONITORS	
APPLE 1705	\$695
CPD200SX	\$689
PRECISION. 21"SR	\$3299
CPD 100SX	\$379

ALL APPLE PARTS & ACCESSORIES IN STOCK  
Leasing / Rentals / Supplies  
Service available in NYC area

1 800 275-9924  
in NY 516 737-0800  
FAX 516 737-0923  
331E DANTE COURT HOLBROOK NY 11471

CIRCLE 411 ON READER SERVICE CARD

Want bargains online?  
Bookmark the  
Mac Shopper at:

[www.macworld.com/buyers/shrfamed.htm](http://www.macworld.com/buyers/shrfamed.htm)

Advertise at (800) 888-8622

## Mac POWER

Sales & Service, Inc.  
BUY • SELL • TRADE  
UPGRADE • REPAIR  
New • Used • Refurbished

- Powrbooks
- PowrMacs
- Performas
- Quadras
- MacII-LC
- Monitors
- Printers
- Periph.
- Ram
- Parts

**888-275-POWER**  
San Jose, California, 95123

# FAST CASH

[www.mactraders.com](http://www.mactraders.com)

For ALL Macs, Memory & Peripherals — Working or not

## TOP DOLLAR PAID

Mac Traders (800)990-0995

(310) 576-2466 Mon.-Fri. 9 AM-6 PM Sat. 10 AM-4 PM (P.S.T.) Fax: (310) 394-7323  
1511 Lincoln Blvd. (bet. Broadway & Colorado), Santa Monica CA. 90401





**800 • 801 • 4MAC**  
**FAX • 310 • 533 • 0501**  
<http://www.microoutlet.com>  
[email:sales@microoutlet.com](mailto:sales@microoutlet.com)

VISA MasterCard Discover American Express

**Free Utilities CD's With Every CPU Order!**

**POWER MAC 9600/8600 SERIES**

**Power Mac 8600/300**  
 32/4GB/24XCD/ZIP  
**\$97.00**

9600/300	64/4GB/24XCD/L2/Zip	\$ 3359
9600/300	64/4GB/24XCD/L2	3275
9600/300	0/0/CD	2749
9600/233	32/4GB/12XCD/L2/VC	2919
9600/233	32/0GB/12XCD/KEY	2429
8600/300	32/4GB/24XCD/L2/Zip	2819
8600/300	32/4GB/24XCD/L2	2735
8600/250	32/4GB/24XCD/L2/Zip	2399
8600/200	32/2GB/12XCD/L2/Zip	2149

**POWER MAC 4400/7300 SERIES**

**Power Mac 6500/300**  
 64/6GB/CD/ZIP/MD  
**\$79.00**

4400/200	32/2GB/12XCD/33.6/MS	\$ 1499
4400/200	16/2GB/CD/1660DS/SB	2279
7300/200	32/2GB/12XCD/L2	1949
7300/180	16/2GB/12XCD/L2/Dos	2775
7300/180	16/2GB/12XCD/L2	1799
6500/300	64/4GB/CD/ZIP/33.6/Home	2299
6500/275	48/6GB/CD/Sm Business	2579
6500/250	32/4GB/CD/ZIP/56K/Home	1879
6500/225	32/3GB/CD/ZIP/33.6/HU	1499

**POWERBOOKS**

**Power Book 3400C/240**  
 16/2GB/6XCD  
**\$139.00**

3400C/240	16/3GB/12XCD/33.6	\$ 4049
3400C/200	16/2GB/6XCD/33.6	3170
3400C/200	16/2GB/12XCD/33.6	3399
3400C/180	16/1.3GB/6XCD/33.6	2799
2400C/180	16/1.3GB/Floppy/OS8	3125
1400C/166	16/1GB/6XCD	2499
1400C/133	16/1GB/8XCD	2394
1400CS/133	16/1.3GB/8XCD	1899

**SERVERS**

**Work Group 9650/350**  
 64/2X4GB/CD/AS/Enet  
**\$226.00**

**WORKGROUP SERVERS**

7350/180	48/4GB/12XCD/AShare	\$ 2649
9650/233	64/4GB/CD/Internet	4849
9650/233	64/2X4GB/12XCD	5128
9650/233	64/4GB/CD/DAT/AShare	5875

**NETWORK SERVERS**

500/132	32/1GB/CD	\$ 6725
700/150	48/4GB/CD/DAT/UNIX *	9248
700/150	32/1GB/CD/UNIX *	7365
*	= Requires AIX	1289

**Scanners**

**La Cie SilverScan IV Office**  
**\$899.00**

AGFA Arcus II Bundle	\$ 1525
AGFA SnapScan 600	379
AGFA SnapScan 310	225
Epson Express. 636 Artist	619
Epson Express. 636 Executive	735
Epson Express. 636 Profess.	1249
H.P. 5P Mac 600 dpi LE Photo	299
La Cie SilverScan IV Office	899
Linotype Linocolor Jade 600 dpi	479
Microtek Scanmaker E3	149
Microtek Scanmaker III w/Photo	1325
Umax Astra 600S 300 dpi	179
Umax Astra 1200S 600 dpi	379
Umax Powerlook II & Trans	1259

**Apple Multiscan 750AV 17"**  
**\$899.00**

**Monitors**

Apple Multiscan 15" AV	\$ 375
Apple SnapScan 750	799
Apple Applevision 750 AV	899
Apple Multiscan 850AV 20"	1825
Hitachi Superscan MC20	1325
Iiyama VisionMaster Pro 21	1469
La Cie Electron 21"	1479
Mitsubishi Diamond Pro 911xm	1429
NEC Multisync M700	740
Radius Pressview 21SR	3089
Sony Multiscan 200SF	659
Sony Multiscan 200SX	599
Viewsonic Optquest V773	499

**Apple LaserWriter 8500**  
**\$2349.00**

**Printers**

Apple Stylewriter 4100	\$ 239
Apple Stylewriter 4500	339
Apple LaserWriter 4/600	689
Apple LaserWriter 12/640	1249
Apple MD1000 Micro Dry Mac/PC	389
Epson Stylus Color 600 1440dpi	279
Epson Stylus Color 800 1440dpi	369
Epson Stylus Photo 8 Color/720dpi	439
GCC Elite XL 608 600 DPI	2259
GCC Elite XL 808 800 DPI	2839
GCC Elite XL 1208 1200 DPI	5599
HP LaserJet 6MP	879
HP Color LaserJet 5M	4685

**EXPANSION CARDS/CAMERAS**

**DOS CARDS**

Apple Pentium 166mhz	\$ 799
Apple Pentium 100mhz	499
Apple 586 100mhz	399

**PROCESSOR UPGRADE CARD**

Newer Tech. Max Power 604/450 Mhz	\$ 1099
Newer Tech. Max Power 604/225 Mhz	775

**DIGITAL CAMERAS**

AGFA Ephoto 307	\$ 289
Apple Quicktake 200	489
Epson Photo PC Mac Version	249
Epson 500 w/Flash Mac Digital Camera	399
Fujitsu DS-7	call
Kodak DC 120 Digital Camera	725
Olympus D320L 1024x768 Resolution	669
Sony DSC-F1 w/Flash 4mb Color LCD	589

**REMOVEABLE HARD DRIVES**

Omega Zip+ 100MB & Cartridge Ext.	\$ 189
Omega Zip 100MB & Cartridge Int.	166
Omega Jaz 1GB Retail & Cart. Int.	289
Omega Jaz 1GB Generic & Cart. Ext.	359
Omega Jaz 1GB Retail & Cart. Ext.	399
Omega Jaz 1GB Retail & 4 Cart. Ext.	589
Syquest EZ 230 MB & Cartridge	169
Syquest Syjet 1.5GB & Cartridge Int.	329
Syquest Syjet 1.5GB & Cartridge Ext.	429
Syquest Syjet 1.5GB & Cart. House Ext.	379
Fujitsu 840 MB Dynamo Int.	389
Fujitsu 840 MB Dynamo Ext.	449
Olympus 230 MB PowerMo Ext.	349
Olympus 2.6 GB PowerMo Ext.	1899
Pinn. Micro 4.8 GB Apex Ext.	1260
VST 230MB Opt. Dr. PB 3400	435
VST 230MB Opt. Dr. PB 1400	399
VST ZIP DRIVE Exp Bay PB 1400	315

**PERIPHERALS**

**CACHE CARDS**

256K L2 Dimm 6400/4400 Series	\$ 110
512K L2 Dimm 6400/4400 Series	155
256K L2 Dimm, 7200-8500 Series	39
512K L2 Dimm, 7200-8500 Series	139

**REMOVEABLE CARTRIDGES**

Nomol 200MB or 270MB	\$ 25
Verbatim 200MB or 270MB	25
Verbatim 200MB or 270MB	56/40
Syquest EZ 135MB / 230MB	18/25
Omega Zip 100MB/10 Pack	18/14
Omega JAZ 1GB Cart/5 Pack	83/399

**DRAWING TABLETS**

Wacom ArtZ II 8x8 w/Ultra Pen	\$ 280
Wacom ArtZ II 12x12 w/Ultra Pen	380
Wacom ArtZ II 12x18 w/Ultra Pen	645
Wacom ArtZ II 18x25 w/Ultra Pen	1815

**VIDEO EXPANSION**

**Video Cards**

ATI Exclaim 3D 4mb V-card	\$ 189
ATI Exclaim 3D 8mb V-card	249
IMS Twin Turbo 2mb V-card	199
IMS Twin Turbo 4mb V-card	325
IMS Twin Turbo 8mb V-card	525
Matrox Millennium 4mb V-card	236
Matrox Millennium 8mb V-card	345
Number 9 Imagine 128 8mb V-card	699
Radius Thunder 30/1600	475
Radius Thunder 30/1920	619
Radius Videovision V2.0	2248
TrueVision Targa 1000 w/Premiere	1599
TrueVision Targa 2000	2939
TrueVision Targa 2000 Pro	3289

**VRAM**

1MB 7300,8600,9500,9600 Series	\$ 29
--------------------------------	-------

**KEYBOARDS/MODEMS**

**KEYBOARDS**

Apple Design Keyboard	\$ 55
Apple Extended Keyboard II	79
Generic Extended Keyboard	29

**MODEMS**

Farallon Netopia (ISDN)	\$ 329
Global Village Teleport 56K Fax v.34 X2	159
Global Village Teleport 56K Fax v.34 K2	159
Global Village PowerPort 56K PC Card	259
Global Village PowerPort Plat 28.8 PC Card	219
Supra Express Modem 33.6	92.0
Supra ExpressFax Modem 56E V.34	129
Supra Express 56E Speakerphone	139
U.S. Robotics Sportster 56K V.34	129
U.S. Robotics Sportster 56K V.34	129
Zoom 33.6 Int. 14.4 Fax PC Card	155

**HARD DRIVES**

**Quantum Stratus 4.3 GB**  
**\$359.00**

DRIVE	INT.	EXT.
Apple 2.1 GB	\$ 199	\$ 259
Quantum Stratus 2.1 GB	239	299
Quantum Stratus 3.2 GB	317	372
Quantum Stratus 4.3 GB	359	419
Quantum Stratus 6.4 GB	489	549
Seagate Barracuda 4.2 1 GB	451	511
Quantum Atlas II 4.5 GB N	599	659
Quantum Atlas II 4.5 GB W	599	659
Seagate Barracuda 4.5 GB N	650	710
Seagate Barracuda 4.5 GB W	654	714
Seagate ST34501N Cheetah 4.5GB	719	819
Seagate ST34501W Cheetah 4.5GB	757	857
Quantum Atlas II 9.0 GB N	999	1059
Quantum Atlas II 9.0 GB W	999	1059
Seagate Barracuda 9.0 GB N	919	979
Seagate Barracuda 9.0 GB W	987	1047
Seagate Elite 23.0 GB N	2000	2100
Seagate Elite 23.0 GB W	2055	2155

**MEMORY**

**MEMORY SALE!**

4MB 72 Pin Simm	\$ 21
8MB 72 Pin Simm	34
16MB 72 Pin Simm	69
32MB 72 Pin Simm	119
8MB Powerbook 1400 Module	87
16MB Powerbook 1400 Module	125
24MB Powerbook 1400 Module	159
32MB Powerbook 1400 Module	200
16MB Powerbook 2400c Module	79
24MB Powerbook 2400c Module	159
32MB Powerbook 2400c Module	329
16MB Powerbook 3400c Module	133
24MB Powerbook 3400c Module	169
32MB Powerbook 3400c Module	179
64MB Powerbook 3400c Module	419
128MB Powerbook 3400c Module	799
8MB 168 Pin Dimm 60NS 5Volts	44
16MB 168 Pin Dimm 60NS 5Volts	79
32MB 168 Pin Dimm 60NS 5Volts	129
64MB 168 Pin Dimm 60NS 5Volts	219
8MB 168 Pin Dimm 60NS 3Volts	69
16MB 168 Pin Dimm 60NS 3Volts	84
32MB 168 Pin Dimm 60NS 3Volts	139
64MB 168 Pin Dimm 60NS 3Volts	245

**LEASING SPECIALISTS**

- Fast Approval
- Very Low Yield Rates
- Three Buyout Options
- Tax Deductible
- Business or Personal Leasing
- Ask for the Leasing Department

**BankVest**  
 A Division of Citicorp

**8600/300 MHz**  
 • 32MB RAM / Zip  
 • 4GB HD, 24 X CD  
 • Apple 750AV Mon.  
 • Keyboard

**\$128.00**

Per Month, For 36 Months

**3 Year Extended Warranty Available!**

**LEASE SPECIALS**

Model	Configuration	Buy	Lease
9600/300	64/4GB/CD/Zip	\$ 3359	\$ 115
8600/300	32/4GB/CD/Zip	2819	97
8600/250	32/4GB/CD/Zip	2399	82
8600/200	32/2GB/CD/Zip	2149	74
7300/180	16/2GB/CD/Dos	2775	95
3400C/240	16/3GB/CD/33.6	4049	139
3400C/200	16/2GB/CD/33.6	3259	112
3400C/180	16/1GB/CD/33.6	2899	99
2400C/180	16/1GB/OS8	3125	107
1400C/166	16/1GB/6XCD	2499	86
1400C/133	16/1GB/8XCD	2395	82

**3400C 200 MHz**  
 • 16MB RAM  
 • 2 GB HD  
 • 12 X CD  
 • 33.6 Modem

**\$112.00** Per Month, For 36 Months

**19800 Hawthorne Boulevard #258 TORRANCE, CA • 90503 PHONE: 310-533-0496 FAX: 310-533-0501**  
**BUSINESS HOURS: MONDAY-FRIDAY 7:00 AM to 7:00 PM PST SATURDAY 10:00 AM to 2:00 PM PST**

Due to publication time, the advertising prices may vary. All prices includes cash discounts. Not responsible for typographical errors. Shipping and service fees are non-refundable. No sales tax outside of CA. All returns subject to 15% restocking charge. All returns must have an authorization number (R.M.A.) Graphics shown do not necessarily represent actual product.



**RE-WRITE** **MS**

**CD-RW Technology Is Here!**

**A/D**  
CD RECORDERS

-2X write/6X Read  
-ReWrite up to 1,000 times!  
-Great Replacement to Tape Backup

-INTERNAL

**\$479**

**RECORD** **MS**

**4x/6x write read**

**Recordable CD**

**A/D**  
CD RECORDERS

-2MB Cache Buffer  
-250 ms access speed  
-Yamaha inside, Great for Audio  
-FREE software, cables & 1 piece of media!

-INTERNAL

**\$499**

**\$349** SONY **\$449**  
2X/6X write read 4X/4X -INTERNAL

**AS LOW AS \$2.49 EACH!**

**Now lower than ever! How about \$2.49 each for GOLD!**

**CD Recorders** int. ext.

AVD 4X/6X Yamaha	\$499	\$549
AVD 4X/4X Teac	\$449	\$499
AVD 2X/6X Sony	\$349	\$399
AVD 2X/6X ReWritable	\$479	\$529

**RECORD** **MS**

**Jaz 1GB or SyJet 1.5GB & CD-R Duo!**

**EXTREME**

-Keep your workspace clean with the Extreme  
-Simple Drag & Drop from SyJet or Jaz to CD-R  
-Complete w/ software, cables & media for Jaz or SyJet & CD-R!

-SONY 2X/6X

**\$749**

**NEW!** **Picasso LABEL** **MS**

**Print perfect color directly to your CDs!**

**Picasso**  
CD COLOR PRINTER

-Complete CD-R Printing Solution  
-Quick Dry Ink, Not Tacky!  
-Bright, Vibrant Colors  
-Accepts Most Printable Media

**FREE 10 PIECES OF PRINTABLE MEDIA!**

**\$1199**

**JAZ/CD-R Duo** ext.

JAZ 1GB & 4X/6X Yamaha	\$949
JAZ 1GB & 4X/4X Teac	\$899
JAZ 1GB & 2X/6X Sony	\$749
JAZ 1GB & 2X/6X ReWritable	\$949
Fast Audio Capture & CD Copy 4X Write/6X Read/12X Read 4X Write/6X Read/20X Read	\$849 \$899

**SYJET/CD-R Duo** **new** ext.

SYJET 1.5GB & 4X/6X Yamaha	\$949
SYJET 1.5GB & 4X/4X Teac	\$899
SYJET 1.5GB & 2X/6X Sony	\$749
SYJET 1.5GB & 2X/6X ReWritable	\$949

**OTHER** int. ext.

12X Read - Plextor CDROM	\$239	\$299
20X Read - Plextor CDROM	\$269	\$349
JAZ 1GB Drive + Cartridge	\$299	\$399
SYJET 1.5GB Drive + Cart.	\$299	\$399

**DATA STORAGE**

**NEW!**

**4.6GB Magneto Optical Drive!**

**Verbatim**  
A Subsidiary of Mitsubishi Chemical Corporation

-Fast 3.5MB/second data transfer rate!  
-About 2 cents per MB!  
-Complete w/ software, cables & 4.6GB removable media!

-EXTERNAL

**\$999**

**DUPLICATE** **MS**

**Standalone 50-CD Duplication**

**\$5999**

**new**

**Standalone 150-CD Duplication**

Available with two 4X CD Recorders **\$6999**

**MediaFORM CD-2-CD**  
Standalone, duplicate to any format **\$2699**

-Simple setup & operation!  
-Complete with 50 Caddys!  
-Press one button & leave!

**MEDIA**

128MB Optical \$6.99	SyJet 1.5GB \$89
230MB Optical \$9.99	Syquest* 44MB \$29
590MB Optical \$23.99	Syquest* 88MB \$34
640MB Optical \$27.99	Syquest 135MB \$19.99
650MB Optical \$27.99	Syquest* 200MB \$53
1GB Optical \$89.99	Syquest 270MB \$55
1.2GB Optical \$27.99	ZIP 100MB \$12.99
1.3GB Optical \$27.99	JAZ 1GB \$89
2.3GB Optical \$55.99	DLT 10/20GB \$39.99
2.6GB Optical \$55.99	DLT 15/30GB \$47.99
CD-ReWritable \$22.99	DLT 20/40GB \$106.99

\* = Syquest Compatible

**SOFTWARE**

CD-DA: Pro Audio Mastering	\$359
CD Copy: Copy any data/audio CD	\$99
Toast 3.5: #1 CD Writing Software	\$99
Toast/CD-Copy/CD-DA: Mega Pack	\$499
M-Pack: MPEG Encoding Software	\$399
Masterlist CD: Pro Audio CDs	\$499
Intech CD ROM Speedtools	\$20
PRO Tools: multitrack digital audio	\$599
Audiomedia III: PCI Audio I/O Card	\$699

**ORDER TOLL FREE!** Product Prices and Availability Subject To Change.

VISA MasterCard AMERICAN EXPRESS P.O.s

**800.555.5551**

Open Mon - Fri 7 a.m. - 6 p.m. (PST) • international phone 714-974-5551 • FAX 714-279-1690

**MEDIASTORE**  
www.mediastore.com

Ad Code: BB-101



**POWERMAC 9600**

300MHz 604e 64/4GB/24xCD

**\$2999****POWERBOOK 1400C**

166 Mhz/16/2GB/CD

**\$2389****ICN**

INNOVATIVE COMPUTER &amp; NETWORKING, INC.

**POWERBOOK 3400C**

240 Mhz/16/3GB/CD

**\$3599****POWERMAC 7300**

200MHz 604e 32/2GB/12XCD/L2

**\$1699****GENUINE APPLE 233MHz 604e PROCESSOR UPGRADE  
7300/7500/7600/8500/9500/9600**

Improves overall system performance by 158%.

Integrated floating\_point coprocessor, with 32K on\_chip cache

**\$390****POWERMACS****▶ 9600**

350MHz 604e/64/4GB/24xCD/KB .....\$4399

300MHz 604e/64/4GB/24xCD/KB .....\$2999

233MHz 604e/32/4GB/12xCD/KB .....\$2579

200 Mhz MP604e/32/4GB/12xCD/KB .....\$3329

200 Mhz 604e/32/4GB/12xCD/KB .....\$2469

**9500**

200MHz 32/2GB/CD\* .....\$1979

**▶ 8600**

300MHz 604e/32/4GB/24XCD/L2 .....\$2599

250MHz 32/4GB/24XCD/1MB Cache .....\$2179

200MHz 604e/32/2GB/12XCD/L2 .....\$1999

**▶ 7300**

200 Mhz 604e 32/2GB/12xCD/L2 .....\$1699

180MHz 604e 32/2GB/12xCD/PC COMPATIBLE .....\$2399

180MHz 604e 16/2GB/12xCD/L2 Cache .....\$1749

**▶ 6500**

300 Mhz 64/6GB/24XCD/L2/ZIP/56.6 Mod \$2999

275MHz 48/6GB/24XCD/L2/ZIP/56.6 Mod \$2799

275MHz 32/6GB/24XCD/L2/ZIP/56.6 Mod \$2499

250MHz 32/4GB/24XCD/ZIP/56.6 Mod \$1999

225 Mhz 32/3GB/12XCD/L2/33.6 .....\$1599

**▶ 4400**

200MHz 32/2GB/CD/L2 Cache/KB .....\$1349

**POWERMAC 8600**

250MHz 604e 32/4GB/24xCD/KB

**\$2179****APPLE VISION 20"  
850 DISPLAY****\$1469****UMAX**

SUPER MAC S900L/225 Mhz 604e/32/2.1GB/8XCD/IMS 8MB \$2299

SUPER MAC S900/250 Mhz DP 604e/64/2x2GB/12XCD/ZIP/KYBD \$6135

SUPER MAC S900/250 Mhz 604e/32/2x2GB/8XCD/ZIP/KYBD \$3129

SUPER MAC S900/233 Mhz 604e/32/2GB/8XCD/KYBD \$2729

SUPER MAC S900/180DP Mhz 604e/32/2GB/8XCD/KYBD \$2695

SUPER MAC J700/180 Mhz 604e/24/2GB/8XCD/KYBD \$1699

SUPER MAC C600/240 Mhz 603e/24/2GB/8XCD/KYBD/Modem \$1389

SUPER MAC C600/180 Mhz 603e/16/1GB/8XCD/KYBD/Modem \$1059

UMAX AUTHORIZED SERVICE CENTER

**POWERBOOKS**

3400c 240 Mhz/16/3GB/CD .....\$3599

3400c 200 Mhz/16/2GB/CD .....\$2899

3400c 180 Mhz/16/1.3GB/CD .....\$2749

2400c 180 Mhz/16/1.3GB .....\$2890

1400cs 133 Mhz /16/1.3GB/CD .....\$1779

1400c 166 Mhz/16/2GB/CD .....\$2389

DUO 2300c 100MHz/8/750\* .....\$1099

Apple Emate 300 .....\$759

PowerBook 100 &amp; 500 Series In Stock

**Duo Upgrade**

200 Series To 2300 Series

**\$599****QuickTake 200** Camera \$419

4MBSmartMedia Card

For QuickTake 200 \$89

FOR CURRENT PRICES VISIT OUR WEB SITE AT:

<http://www.icni.com>**1.888.505.2211**

Fax:(310)445-6611 Tel:(310)445-6600

FAX TOLL FREE FROM JAPAN: 00-31-114211

2045-B S. Barrington Ave. LA, CA 90025

**MONITORS**

APPLE VISION 850 .....\$1469

APPLE 20" Multi\* .....\$1099

APPLE VISION 750 .....\$779

APPLE VISION 750 AV .....\$859

APPLE 1705 Multi .....\$489

APPLE 15" AV Multi .....\$359

APPLE 15" Multi .....\$319

NEC E500/E700 .....\$379-659

NEC 21" P1150/E1100 .....\$1499-1399

SONY 15" 100SX/15"100SF .....\$339-369

SONY 17" 200SX/17"200SF .....\$609-649

SONY 20" 300SF/20"SE2 .....\$1379-1869

VIEWSONIC 15" GS/ GA .....\$329-379

VIEWSONIC 17" GA/ PT770 .....\$599-689

VIEWSONIC 20" P810/ P815 .....\$1289-1449

VIEWSONIC 20" PT813/ G810 .....\$1429-1249

**PRINTERS**

APPLE LaserWriter COLOR 12/660 .....\$3990

APPLE LaserWriter 12/640 .....\$1090

APPLE LaserWriter 8500 .....\$CALL

APPLE LW 16/600 .....\$1449

APPLE LW 4/600 .....\$789

APPLE SW Color 2200 .....\$279

APPLE SW 1500 .....\$169\*

APPLE SW 1200 .....\$99

APPLE SW Color 4100 .....\$249

APPLE SW Color 4500 .....\$339

APPLE SW Color 6500 .....\$445

EPSON STYLUS 600/800 COLOR .....\$279/\$379

**PERFORMAS**

6400 180MHz/16/1.6GB/CD/KB .....\$1099\*

6400 200MHz/16/2GB/CD/KB .....\$1299\*

6360 160MHz/16/1GB/CD/KB .....\$999\*

6200 75MHz/8/1GB/CD/KB .....\$599\*

**UPGRADES**

WITH ORIGINAL APPLE LOGIC BOARD

PM 8500 LOGIC BOARD UPGRADE

FROM Q800, Q840AV, PM 8100 TO 8500 \$895

PM 7600 LOGIC BOARD UPGRADE

FROM PM 7200 TO 7600 .....\$689

PM 5300/6300 UPGRADE L.B.(100MHZ)

FROM Q630, PF630, PF 5200 &amp; 6200 \$349

Workgroup Server 9150/80 L.B. Upgrade

FROM 950, 900 .....\$599

DUO UPGRADE 200 Series To 2300 .....\$599

200MHz MP Processor Upgrade .....\$989

Prices Subject to Change Without Notice

All Prices reflect 3% Cash Discount \* \* Refurbished



# 800-689-3933

Service (310) 479-0999  
Fax (310) 312-9041

# L.A.



## Computer center

### Monitors



**RASTEROPS**  
MC7515 19" .22DP  
1600X1200 Monitor  
**\$979.**

**RASTEROPS HITACHI**  
3 year warranty



Mc 620 17" .28dp 1152X870 499.  
Mc 6315 17" .22dp 1280X1024 649.  
Mc 7515 19" .22dp 1600X1200 979.  
Mc 801 21" .22dp 1600X1200 1449.  
Mc 801HR 21" .22dp 1600X1280 1649.

### SONY

Sony 100SF 339.  
Sony 100SX 15" 319.  
Sony 200SF 649.  
Sony 200SX 17" 579.  
Sony 300SF 20" 1329.  
Sony 20SE II 20" 1749.

**Corporate Accounts**  
Welcome  
**Business Leasing**  
Available  
**Reseller Inquiries**  
Welcome  
**Fortune 1000, University,  
School, & Government**  
Purchase Orders Accepted  
**We Also carry Toshiba,  
Compaq, IBM notebooks.**

### Scanners

Agfa Arcus II 1499.  
Agfa StudioStar w/ Full Photoshop 879.  
Agfa StudioScan Ili w/LE Photo 599.  
Agfa SnapScan 300 299.  
Umax Astra 8005 w/Photo Dlx. 179.  
Umax Astra 1200S w/Photo Dlx. 299.  
Umax Powerlook II w/ Photo Full 1199.  
Umax Powerlook 2000 3350.  
Umax Mirage II SE w/Trans. Adapter 3699.  
Microtek Scanmaker V300 199.  
Microtek Scanmaker III Full Photo/Trs. Ada. 1399.

### Monitors

**NEC**  
Multisync M700 17" 25mm 769.  
Multisync E1100 21" 28mm 1299.  
Multisync P750 17" 25mm 799.  
Multisync M500 15" 25mm 399.  
Multisync P1150 21" 25mm 1449.  
Multisync XV174 17" 28mm 699.  
Multisync XP37 37" 85mm 7199.

**radius**  
SuperMac 21TXL w/calibrated 1099.  
SuperMac 17XL 17" 399.  
Precision View 21" 1579.  
Presview 17" SR 2899.  
Presview 17" SR 1599.  
Thunder 30/1600 599.  
Thunder Power 30/1920 849.  
Thunder TX 1152 1049.  
Thunder 3D 1699.

### ViewSonic

15GS 15" 1280x1024 .27dp 349.  
15GA2 15" 1280x1024 w/spkr. 27dp 369.  
17EA 17" 1024x768 w/spkr. 27dp 499.  
17PS 17" 1280x1024 .27dp 599.  
17PS 17" 1600x1280 .25dp 649.  
GB80 20" 1600x1200 .28dp 1049.  
PB15 21" 1600x1200 .25dp 1399.  
GB10 21" 1600x1200 .28dp 1199.  
PB10 21" 1600x1200 .25dp 1299.

**Apple 1705  
17" Monitor  
\$499**

Apple 15" AV 359.  
Apple 15" 299.  
Apple 1710 17" 649.  
Apple 720 17" CALL.  
Apple 750 17" 799.  
Apple 750 AV 17" 899.  
Apple 850 20" 1449.  
Apple 850 AV 20" 1749.

### Apple Processors

Apple 132 MHz 604e 99.  
Apple 150 MHz 604e 149.  
Apple 200 MHz 604e 499.  
Apple 233 MHz 604e 599.

### Newer Technology

MAXpower 200MHz 604e with S+ 599.  
MAXpower 225MHz 604e with SBT 699.  
MAXpower Citation 200MHz 604e no SBT 349.  
MAXpower Citation 233MHz 604e no SBT 439.  
MAXpower Pro 250MHz 750 512k Bkstd. Cache 1199.  
MAXpower Pro+266MHz 750 1MB Bkstd. Cache 2099.  
NUPOWER 1400 183MHz 603ev 128K12 Cache 549.  
NUPOWER PB 500 183MHz 603ev 699.  
VIE/POWER PB1400 16bit video card 249.  
PC Card Video In/Capture 269.

### FedEx

**WE SHIP WORLDWIDE  
NEXT DAY SHIPPING  
- SAME DAY SHIPPING**

### Macintosh PowerMac's



**8600/300**  
• 32MB  
• 4GB  
• 24CD  
• KEYBOARD  
**\$2599**

**9600/300**  
• 64MB  
• 4GB  
• 24CD  
• 3MB VIDEO RAM  
**\$2999**

9600/350 64/4G/24CD CALL.  
9600/233 32/4G/12xCD 2699.  
9600/200 32/4G/12xCD 2399.  
9600/200MP 32/4G/12xCD 2999.  
9500/150" 16/2G/4xCD 1999.  
8600/300 32/2G/8xCD/ZIP 2799.  
8600/250 32/4G/12xCD 2099.  
8600/200 32/2G/CD 1999.  
8500/180" 32/2G/8xCD 1799.  
8500/150" 16/2G/CD 1499.  
7600/132" 16/1.2G/CD 1699.  
7300/200 32/2G/CD/KBRD. 1599.  
7300/180 16/2G/12xCD/ZIP 2299.  
7200/120" 16/1.2G/4xCD/DOS 1299.  
7200/90" 8/500/4xCD 1149.  
6100/66" 16/500/4xCD/DOS 749.  
4400/200 16/1.2G/12xCD/DOS 899.  
4400/200 16/2G/12xCD/KB/Ethernet 1249.  
4400/200 16/2G/12xMS office 1249.  
4400/200 32/2G/12xPentium 1999.  
6500/225 32/3G/12x 1399.  
6500/250 32/4G/12x/Zip Drive 1799.  
6500/250 48/4G/12x/MS Office 1879.  
6500/275 32/4G/CD/MDM 2099.  
6500/300 64/4G/CD/Zip 2099.

### Macintosh Performas



6360/120" 16/1.2G/CD 799.  
6400/200 16/2.4G/8xVDE 1599.  
6400/200 16/2.4G/8xVDE 1049.7/1199.  
6400/180 16/1.6G/8xVDE 899.7/1099.  
6400/3D0S" 12/500/CD/DOS 899.  
6320/120 16/1.2G/4xCD 1199.  
6320/120 16/1.2G/4xCD/TV/with monitor 1199.  
6220/75" 16/1.2G/4xCD 699.  
6200/75" 8/1.2G/4xCD 599.  
5400/120" 16/1.6G/CD/15" built in 1199.  
5200/75" 8/800/CD 699.  
LC580 8/800 699.

750MB MAC external 299.  
750MB MAC Cartridges 59.  
750MB MAC Cartridges 3-Pack 149.  
EZ135 MAC Cartridges 17.  
EZ135 MAC Cartridges 10-Pack 159.  
CD-R Media Single/10-Pack 5/35.

### NOMAD

Global Village  
GV 56K Teleport 299.  
GV 56K PCMCIA 269.  
GV 56K Platinum Pro + Ethernet 379.  
GV 19.2 Mercury PB 500 Series 149.  
GV 14.4 Gold PCMCIA 159.  
GV 14.4 Gold Teleport External 5/35.

### UMAX

S910DP 250MHz 64/4G RAID/24x8MBVR/ZipE100 6099.  
S900DP 250MHz 64/4G RAID/8x8MBVR/Zip108T 5999.  
S900/250MHz 32/2G/8x8MBVR/Zip108T 2999.  
S900/233MHz 32/2G/8x8MBVR 2499.  
S900/200MHz 32/2G/8x8MBVR 2149.  
J700/180MHz 24/2G/8x8MBVR/3.5 1599.  
C600X/280MHz 32/4G/12x2MBVR/108T/3.5 1999.  
C600X/240MHz 32/3G/12x2MBVR/108T/3.5 1649.  
C500L/200MHz 16/2G/12x1MBVR/3.5 1049.  
C500LT/200MHz 16/2G/8x1MBVR 999.

### Tektronix

Phaser 140 COLOR 949.  
Phaser 300X COLOR 4999.  
Phaser 350 COLOR 2999.  
Phaser 380 COLOR 7899.  
Phaser 450 COLOR 6099.

### Macintosh Powerbooks



**3400/200**  
• 16MB  
• 2GB  
• 12xCD  
**\$2699**

**3400/240**  
• 16MB  
• 3GB  
• 12xCD  
**\$3699**

1999. C: Active Color, CS: Passive Color  
2799. 2300C" 100MHz, 8/750  
2099. 2300C" 100MHz, 20/1GB/1.4  
1999. 1400cs 117MHz 12/750  
CALL. 1400cs 117MHz 16/750/6x Cd  
1999. 1400cs 133MHz 16/1.3GiBx  
1499. 1400c 133MHz 16/1GiB/CD  
1699. 1400c 166MHz 16/2G/CD  
1599. 2400c 180MHz 16/1.3G  
2299. 3400c 180MHz 16/1.3G/12X/Modem  
1149. 3400c 200MHz 16/2G/12x/Modem  
3899. 3400c 240MHz 16/3G/12x/Modem  
1999. 5300cs 32/1G  
1249. 5300c 16/750  
CALL. 5300c 8/500  
1999. **5300cs/100" 16/750/14.4 Modem**  
1399. 540c 4/320 Used  
1999. 520c 4/240  
1879. 520 4/240  
DUO250" 12/200/Modem  
DUO280" 12/240/Modem  
DUO280C" 12/240

### WACOM

AnZ 4x5 139.  
AnZ 6x8 289.  
AnZ 12x12 389.  
AnZ 12x18 599.

### IMS Video

8MB AT Video Card 229.  
4MB AT Video Card XClaim 329.  
4MB AT Video Card VR 379.  
8MB AT Video Card 479.  
2MB IMS Video Card 199.  
4MB IMS Video Card 299.  
8MB IMS Video Card 449.

### Fax Modems

Global Village  
GV 56K Teleport 299.  
GV 56K PCMCIA 269.  
GV 56K Platinum Pro + Ethernet 379.  
GV 19.2 Mercury PB 500 Series 149.  
GV 14.4 Gold PCMCIA 159.  
GV 14.4 Gold Teleport External 5/35.

### Memory

16MB Dimm PPC 79.  
16MB Dimm Performa/PC 79.  
16MB for PwBook 1400/9400 129.  
24MB for PwBook 1400 169.  
32MB Dimm PPC 149.  
32MB Dimm Performa/PC 149.  
32MB for PwBook 1400/9400 249.  
64MB Dimm PPC 249.  
64MB Dimm PwBook 3400 399.  
128MB Simm PPC 849.

### Asante

ASANTE 10b/T Ethernet 59.

### Macintosh Workgroup Servers



9650/350 64/4G/20X/4D Apple Share CALL.  
9650/233 64/4G/12x/Apple Share 5999.  
9650/233 48/4G/12x/Internet Ready 4999.  
9650/233 48/4G/12x/2GB Dat Drv. 5499.  
8550/200 32/2G/CD/Apple Share 4199.  
8550/200 32/2G/CD/Apple Share/Dat 4999.  
7350/180 48/4G/12x/Apple Share 3099.  
7350/180 48/4G/12x/Internet Ready 2899.  
7350/180 48/4G/12x 2449.  
7250/120 16/1.2G/CD/Networking 1299.

### Powerbook Hard Drives

1.4GB Toshiba 1401MAV 12ms 199.  
2.1GB Toshiba 2103MAV 12ms 279.  
3GB Hitachi Slim 12ms 449.

### iomega

Jaz 2GB Drive External SCSI 629.  
Jaz Drive Internal SCSI 299.  
Jaz Drive External SCSI 369.  
Zip Drive Internal SCSI 149.  
Zip Drive External SCSI 149.  
3 Pack Jaz Cartridges 240.  
10 Pack Zip Cartridges 130.  
Single Cartridges for Jaz 89.  
Single Cartridge for Zip 13.

### External Hard Drives

IBM Orion 2.1GB SCSI 3.5 279.  
**IBM Capricorn 4.3GB Ultra SCSI 3.5 349.**  
IBM Capricorn 4.3GB Ultra SCSI 3.5 499.  
Quantum Sonata 2.1GB SCSI 3.5 279.  
Quantum Sonata 4.3GB SCSI 3.5 359.  
Quantum Atlas 4.5 Ultra SCSI AV 3.5 599.  
Quantum Atlas II 4.5 Ultra Wide SCSI AV 3.5 699.  
Quantum Atlas III 4.5 Ultra Wide SCSI AV 3.5 899.  
Quantum Atlas IV 4.5 Ultra Wide SCSI AV 3.5 999.  
799. Seagate Cheetah 4.3 Ultra SCSI AV 10000RPM 899.  
Seagate Cheetah 4.3 Ultra W SCSI AV 10000RPM 899.  
Seagate ST14371W 4.3GB Ultra SCSI 3.5 AV 699.  
Seagate ST14371W 4.3GB Ultra SCSI 3.5 AV 699.  
Seagate Cheetah 9.1GB Ultra SCSI AV 10000RPM 1099.  
Seagate Cheetah 9.1GB Ultra W SCSI AV 10000RPM 1199.

### Software

Microsoft Office 97 299.  
Microsoft Word 97 199.  
Microsoft Excel 97 199.  
Microsoft PowerPoint 97 199.  
MacroMedia Director 499.  
MacroMedia Access 97 199.  
Adobe Photoshop 4.0 349.  
Adobe Pagemaker 6.5 349.  
Adobe Illustrator 299.  
MacroMedia Freehand 299.

### Printers

HP DeskJet 340 299.  
HP DeskJet 670C/692C 199/299.  
HP DeskJet 620C/618/707X 279/399.  
HP LaserJet 6L/16/7P/1 385/729.  
HP LaserJet 6MP/5M 849/1399.  
HP LaserJet 5/5N 949/1199.  
HP LaserJet 4V/4MX 1699/2399.  
HP LaserJet 5SI/5MX 2299/3399.  
HP Color LaserJet 5/5M 3799/4799.  
HP OfficeJet 500/1150C Pro 599/939.

### EPSON

Epson Stylus Color 600/800 289/389.  
Epson Stylus Color 3000 CALL.  
Apple Select 960" 899.  
**Apple Demo Ctr LaserWriter 12/660 24ms/24hd 1049.**  
Apple Laser 12/450 2499.  
Apple Laser 16/600PS 1199/1399.  
Apple LaserWriter 8500 CALL.  
Apple StyleWriter 1500 159/199.  
Apple StyleWriter 4100 229.  
Apple StyleWriter 4500 329.  
Apple StyleWriter 6500 379.

### Apple portable 2200 Color Style Writer

**\$279**

## PHILIPS/MAGNAVOX 4 YEAR ON SITE WARRANTY!

ASK YOUR SALES REP REGARDING EXTENDED ON-SITE WARRANTY ON NEW AND REBUILT PRODUCTS.  
THE ON-SITE WARRANTY BEGINS 31 DAYS AFTER THE INVOICE DATE IN MOST SITUATIONS.

\$701 to \$1200	\$1201 to \$2000	\$2001 to \$3000	\$3001 to \$4000	\$4001 to \$5000	\$5001 to \$7500	\$7501 to \$10000	\$10001 to \$15000
\$157.99	\$185.99	\$217.99	\$261.99	\$291.99	\$343.99	\$431.99	\$552.99

Visit Us At Our Web Site <http://www.LACC.com>  
24Hrs A Day -- On-Line Catalog & Ordering  
E-Mail us at: [lacc@lacc.com](mailto:lacc@lacc.com) or Call us at (800) 689-3933

We Beat, We Match, We Deal

Terms & Conditions: All prices are cash discounts. We accept VISA, MC, Amer & Discover. COD orders will be billed by Customer's Check. Money Order or Certified Check only. Purchase orders will be accepted from qualified companies upon approval. Customers must pay for all shipping & insurance fees. One business day shipping in the United States. Delivery is subject to change without notice. Not responsible for typographical errors. Prices given at the time of the sale are final. Shipping, insurance and COD fees are non-refundable. No returns will be given after 30 days. 15% restocking fee on all returns. All returns must have a 1584 number. All returns must have all original packing materials, manuals, warranty cards & all accessories. Trade-ins are required with their respective companies. No returns on software & hardware. Ask for warranty and details at the time you are placing an order.



MW  
0198



**COMPU.D** 1-800-929-9333  
International, Inc. www.compu-d.com

Sales: (818) 787-3282 Fax: (818) 787-5555

e-mail: csales@compu-d.com

All prices are based on C.O.D. order & subject to change!

**Apple PowerMacs**

9600/350	64-4GB, 24xCD	\$4295
9600/300	64-4GB, 24xCD, Zip	\$3145
9600/233	32-4GB, 12xCD	\$2595
8600/300	32-4GB, 24xCD, Zip	\$2695
8600/250	32-4GB, 24xCD	\$2345
8600/200	32-2GB, 12xCD	\$2145
7300/200	32-2GB, 12xCD	\$1695
7300/180DOS	32-2GB, 12xCD	\$2395
6500/300	32-4GB, 12xCD, Zip, 33.6	\$2245
6500/275	64-4GB, 12xCD, TV, Avid	\$2245
6500/250	32-4GB, 24xCD, Office	\$1845

<b>3400c/240 MHz</b>	<b>16/3GB, CD</b>	<b>\$3495</b>
<b>3400c/200 MHz</b>	<b>16/2GB, CD</b>	<b>\$2595</b>
<b>1400c/166 MHz</b>	<b>16/2GB, CD</b>	<b>\$2195</b>
<b>1400cs/133 MHz</b>	<b>16/1.3GB, CD</b>	<b>\$1795</b>
<b>233Mhz Proc. Card</b>		<b>\$395</b>

**Apple PowerBooks**

3400c/240	48-3GB, CD, 10B-T, 56K	\$3995
3400c/200	48-2GB, CD, 10B-T, 56K	\$3195
1400c/166	32-2GB, 8xCD, 33.6	\$2445
1400cs/133	48-2GB, 8xCD, 33.6	\$1995
Duo2300c	8-750 & 40-2.1GB	\$995/1395

**Printers & Displays**

LaserWriter 16/600 PS	\$1095
12/640 PS 12ppm, 600DPI	\$1095
Apple 1705/750 17" Display	\$499/699
Apple Vision 850/850AV	\$1395/1695

**Deals of the Month**

Adobe Photoshop 4	\$345
" PageMaker 6.5	\$345
" Illustrator 7.0	\$239
QuarkXpress 3.3.2	\$625
MS Office 4.2.1	\$259
UMAX Astra 600	\$159
UMAX Astra 1200	\$279
LaCie 2x6 CDR/Toast	\$379
LaCie 4x6 CDR/Toast	\$569

Visit our Web Site for Complete List of Products

**MacGlobal**

SYSTEMS AND PERIPHERALS • SALES AND SERVICE

<b>Performas</b>	<b>PowerBooks</b>
410/466/476 Call	520 4/160 \$850
550 5/160 \$700	520C 12/240/19.2 \$1195
580 5/500/CD \$800	540C 4/320 \$1,395
631 8/500/CD \$550	5300 8/500 \$995
6200 8/1G/CD \$675	
6200 8/500/CD \$995	<b>Quadras</b>
	630 8/250 Call
	650/800/840/950 Call

**Power Macs**

7200 8/500 Call	
7500 16/500 Call	
8500 16/500 Call	

**Printers**

Stylw II	\$185.00
Stylw 1200	\$175
Laser 300	\$299
Laser 320	\$490
Laser 4/600	Call

**Memory**

4 MB 72-pin	\$29
8 MB 72-pin	\$42
16 MB 72-pin	\$89

**Monitors**

14" Color	\$195
15" App. Multi.	\$265
17" App Multi.	\$450
20" GS	\$540

**WE REPAIR MACS!**

TOP DOLLAR paid for memory, PowerBooks and CPUs!

[800] 722-8864  
Phone: [408] 268-3300  
Fax: [408] 997-1400

**MacGlobal**

CIRCLE 423 ON READER SERVICE CARD

**POWERBOOK PRODUCTS**

**IDE PowerBook Drives**

1.0 GB TOSHIBA	\$ 179 <sup>00</sup> 3yr
1.4 GB TOSHIBA	\$ 199 <sup>00</sup> 3yr
2.1 GB TOSHIBA	\$ 249 <sup>00</sup> 3yr
3.2 GB HITACHI	\$ 439 <sup>00</sup> 3yr
4.0 GB IBM	\$ 599 <sup>00</sup> 2yr
5.0 GB IBM	\$ 699 <sup>00</sup> 2yr

**SCSI PowerBook Drives**

810 MB TOSHIBA	\$ 399 <sup>00</sup> 3yr
1.4 GB IBM (converted)	\$ 649 <sup>00</sup> 1yr
2.0 GB IBM (converted)	\$ 879 <sup>00</sup> 1yr

**External Drives**

1.0 GB JAZ DRIVE	\$ 369 <sup>00</sup>
Includes P.B. SCSI Adaptor	
1.0 GB JAZ MEDIA	\$ 85 <sup>00</sup>

For use in PB 3400, 2400, 1400, 6300, 190, 160 & Duo 2300

For use in PB 800 Series, Duo 200 Series, PB140-180c (except 150)

**Don't Trash your old drive!**  
Use our PC-card IDE case and save your megabytes \$129<sup>00</sup>

All MCE PowerBook hard drives carry a 30 day Money Back Guarantee & ship with 1) CharisMac Anubis Formatting Utility Software 2) Illustrated installation manual 3) Anti-static wrist strap, Torx T02 w/driver.

**newer tech**

NUpowr 500/183c (0MB)	- \$ 729 <sup>00</sup>
NUpowr 500/183c (24MB)	- \$ 899 <sup>00</sup>
NUpowr 1400/183	- \$ 549 <sup>00</sup>
NUpowr 500/167c (8MB)	- \$ 579 <sup>00</sup>

MCE powrUP 500/183c Bundle  
Includes: NUpowr 500/183c (24MB) PLUS  
Toshiba 810 MB 2.5" SCSI HD \$ 1239<sup>00</sup>  
Newer tech Ethernet Micro Dock \$ 179<sup>00</sup>

**FREE with every order!**

ADB Flexlight - Great for dark lecture halls, planes, cars or in the field \$29<sup>95</sup> separately

See our complete line of PowerBook Products & Upgrades at [www.PowerBook1.com](http://www.PowerBook1.com)

1-800-5000-MAC • 714-458-0800 • fax 714-458-1303  
30 Hughes Suite 203 • Irvine, CA • 92618  
Visa / MC / AmEx / Discover / P.O.'s

**MACS & POWERBOOKS WANTED**

**TOP \$\$\$ PAID FAST!**

**MAC Solutions**

1933 Wilshire Bl.  
W. Los Angeles, CA 90025  
[www.macsolutions.com](http://www.macsolutions.com)

Any Quantity  
Trade Ups Welcome  
FedEx check delivery  
We Buy, Sell & Trade  
New & Used Macs

**(800) 80-WE-BUY**

Tel: (310) 966-4444 Fax: (310) 966-4433

CIRCLE 427 ON READER SERVICE CARD

**J&J Computers**

14" Apple Multiscan	\$250.00
15" Apple Multiscan	\$275.00
17" Apple Multiscan	\$435.00
PB: 520 8/240	\$879.00
PB: 520c 8/240	\$995.00
PB: 540c 8/320	\$1125.00
PB: 5300 8/500	\$995.00

Buy • Sell • Trade

**1-888-868-1925**

**"Friends don't let friends use 'DOS!'"**

... Buy or Sell Any Macintosh Through Us!

**United Computer Exchange**

800.755.3033 770.612.1205  
Visit Our Online Exchange at [www.uce.com](http://www.uce.com)

CIRCLE 439 ON READER SERVICE CARD

**THE BEST IN REMANUFACTURED Macintosh**

**COMPUTERS & PARTS**

- GENUINE APPLE PRODUCTS AT BIG SAVINGS
- "LIKE NEW" REMANUFACTURED
- SYSTEMS & PERIPHERALS
- EXCHANGE REPAIR & STOCKING PARTS
- 180 DAY LIMITED WARRANTY
- WE BUY YOUR SURPLUS APPLE PRODUCTS

**Pre-Owned Electronics**

**1-800-274-5343**

Offices: 781-778-4600 Fax: 781-778-4848  
128 Middlesex Road, Haverhill, MA 01830

CIRCLE 435 ON READER SERVICE CARD

**MacBYTE**

**NO PAYMENT FOR 6 MONTHS!**

**BUY • SELL • TRADE**

- CASH FOR MACS
- NEW & USED MACS WITH WARRANTIES
- FEDEX OVERNIGHT SHIPPING

Visa/Mastercard/Amex/Discover  
Diners Club/COD

Local Area On-Site Consulting

**800-432-2983**

4223 Glencoe Ave., Suite C200  
Marina del Rey, CA 90292  
FAX: 310-448-4494  
E-MAIL: [MacByte@aol.com](mailto:MacByte@aol.com)

CIRCLE 429 ON READER SERVICE CARD



<b>Power Macintosh®</b> <b>4400</b> 200MHz 200 Office 16/2G/CD/KB 32/2G/CD/KB <b>\$1219 \$1489</b>	<b>Power Macintosh®</b> <b>7300</b> 180MHz 200MHz 16/2G/CD/KB 32/2G/CD/KB <b>\$1739 \$1839</b>	<b>Power Macintosh®</b> <b>6500</b> 225MHz 32/3G/CD/KB <b>\$1489</b>	<b>Power Macintosh®</b> <b>6500</b> 250MHz 250 Office 32/4G/24xCD/56k 48/4G/CD/Zip/KB <b>\$1789 \$1919</b>	<b>Power Macintosh®</b> <b>6500</b> 275MHz 300MHz 32/4G/CD/KB 64/4G/CD/Zip/33.6 <b>\$2239 \$2239</b>
--	--	--	--	--

<b>Power Macintosh®</b> <b>4400/PC</b> 200MHz 32/2GB/12xCD PC Card <b>\$2019</b>	<b>Power Macintosh®</b> <b>8600</b> 200MHz 32/2G/12xCD ZIP/KB <b>\$2079</b>	<b>Power Macintosh®</b> <b>8600</b> 250MHz 32/4G/24xCD ZIP/KB <b>\$2249</b>	<b>Power Macintosh®</b> <b>8600</b> 300MHz 32/4G/24xCD ZIP/KB <b>\$2599</b>	<b>Power Macintosh®</b> <b>9600</b> 200MHz 200MP 32/4G/CD/KB 32/4G/CD/KB <b>\$2369 \$3179</b>
--	---	---	---	---

<b>Power Macintosh®</b> <b>9600</b> 233MHz 32/4G/12xCD <b>\$2749</b>	<b>Power Macintosh®</b> <b>9600</b> 300MHz 64/4G/24xCD ZIP/KB <b>\$3429</b>	<b>Power Macintosh®</b> <b>9600</b> 350MHz 64/4G/24xCD KB <b>\$4899</b>	<b>PowerBook®</b> <b>3400c</b> 200MHz 16/2G/6xCD <b>\$3089</b>	<b>PowerBook®</b> <b>3400c</b> 240MHz 16/3G/12xCD <b>\$4079</b>
--	---	---	--	---

<b>PowerBook®</b> <b>1400cs</b> 117MHz 16/750/CD <b>\$1699</b>	<b>PowerBook®</b> <b>1400c</b> 166MHz 16/2G/8xCD <b>\$2459</b>	<b>SONY</b> <b>100sx/100sf</b> 15" Monitor .25 Dot Pch <b>\$327/349</b>	<b>SONY</b> <b>200sx/200sf</b> 17" Monitor .25 Dot Pch <b>\$585/639</b>	<b>SONY</b> <b>300sf/20SE2</b> 20" Monitor <b>\$1299/1689</b>
--	--	--	--	--

**PERFORMA**

**Sale!**

6360/160 16/1.6/CD/KB 929  
 6400/180 16/1.6/8XCD 1069  
 6400/200 16/2.4/8XCD 1199  
 6400/200 Video Edit. 1599

**WorkGroup®**  
WorkGroup Specialist!

6150/66 16/1.2/INTRNT 999  
 7250/120 16/2GB/INTRNT 1299  
 7350/180 48/4GB/12XCD 2369  
 7350/180 48/4GB/CD/INTRNT 2795  
 7350/180 48/4GB/CD/AShr 2979  
 9650/233 64/4GB/CD/INTRNT 4699  
 9650/233 64/2X4GB/CD 4949  
 9650/233 64/2X4GB/CD/AS 5679  
 9650/233 64/4GB/AS/DAT 5679  
 9650/350 64/4GB/CD/AS CALL  
 500/132 32/CD/BASE 6399  
 500/132 32/2GB/DAT/CD 7789  
 700/150 32/1GB/CD 7349  
 700/150 48/4GB/DAT/CD 9149  
 700/200 48/2-4GB/CD 10789

**Power Macintosh®**

6500/225 32/3GB/CD/33.6 1489  
 6500/250 32/4GB/CD/56k 1789  
 6500/275 32/6GB/CD/Zip 2249  
 6500/275 32/4GB/CD/VID 2239  
 6500/275 48/6/CD/Zip/OFC 2499  
 6500/300 64/4GB/CD/Zip 2239  
 6000/300 64/6/CD/Zip/56K 2519  
 6500/250 48/4/CD/Zip/OFC 1919

**HEWLETT PACKARD**

DeskWriter 680C 289  
 DeskJet 340 Portable 318  
 DeskJet 870CXi 375  
 DeskJet 1600CM 1599  
 LaserJet 6MP 839  
 Color LaserJet 5M 4799  
 LaserJet 4MV 2299  
 LaserJet 5M 1439  
 LaserJet 5SI MX 3349  
 ScanJet 6100C NEW 699  
 DesignJet 755CM Plotter Call

**UMAX**

Astra 600S 169  
 Astra 1200S Deluxe 399  
 Astra 1200S w/full Photo 499  
 PowerLook II Pro 1269  
 Mirage IISe/II 3159/6689

**POWERBOOK®**

Apple eMate 300 769  
 1400CS/117 16/750/CD 1699  
 1400CS/133 16/1.3G/8xCD 1849  
 1400C/133 16/1.3/6xCD 2269  
 1400C/133 16/1.3/8xCD 2439  
 1400C/166 16/2GB/8xCD 2459  
 3400C/180 16/1.3G/12xCD 2899  
 3400C/200 16/2GB/12xCD 3249  
 3400C/240 16/3GB/12xCD 4079  
 5300C/100 8/500/Active 1499  
 DUO 2300C 20/1.1/MDM \*1349  
 DUO 2400C/180 16/1.3G 3149

**UMAX**

C500/180 16/1.2/CD/28.8 1039  
 C600/200 16/2GB/CD/28.8 1199  
 J700/180 24/2GB/CD/33.6 1689  
 S900/200 32/2GB/CD/KB 2329  
 S900/233 32/2GB/CD/KB 2679  
 S900/250 32/2GB/Zip 3349  
 S900/200DP 32/2GB/CD 2959  
 S900/250DP 64/4GB/Zip 6149

**EPSON®**

Expression 636 Exec 699  
 Expression 636 Artist 909  
 Expression 636 Proff. 1249  
 Stylus Color 600/800 255/379  
 Stylus PHOTO/1520 435/729  
 Stylus Color ProXL 1369  
 Stylus Color 3000 1649

**GLOBAL VILLAGE**

Platinum 33.6 89  
 Teleport x2/K56 149  
 Powerport PC 199  
 Powerport Pro 285  
 Powerport PCsex 248  
 Powerport Prosex 285

**ViewSonic**

15GS 15" 329  
 15GA 15" 369  
 17GS 17" 569  
 17GA 17" 607  
 17PS 17" 629  
 GT170 17" 629  
 P810 17" 1349  
 PT170 17" 688  
 PT813 20" 1459  
 P815 21" 1499  
 G810 21" 1399

**Apple® Monitors**

MS 15" \*279  
 MS 15AV 349  
 MS 1705/1710 499/659  
 MS 1710AV 749  
 AppleVision 750 699  
 AppleVision 750AV 819  
 AppleVision 850 1439  
 AppleVision 850AV 1729

**Apple® Printers**

StylWrtr 2200 269  
 StylWrtr 1500/2500 169/209  
 StylWrtr 4100/4500 237/327  
 StylWrtr 6500 449  
 LsrWrtr 8500 2269  
 LsrWrtr 12/640 PS 1069  
 LsrWrtr 16/600 W/Tnr 1579  
 LsrWrtr 12/660Ps Kit 3789

**SONY**

100SX/100SF 15" 327/349  
 200SX/200SF 17" 585/639  
 220vs/17SE2 829/839  
 300SF 20" 1299  
 20SE2 1600X1280.25 1689  
 GDM-W900T 24" 4199

**AGFA**

Arcus II Le/Full 1249/1479  
 StudioStar LE/Full 749/899  
 StudioScanIIsi Le/Full 459/589  
 SnapScan 259  
 EPhoto Digital Camera 279

**WACOM**

Art Pad II 129  
 Art II 6x8 269  
 Art II 12 x 12 399  
 Art II 12 x 18 649

**TARGA**

Targa 2000 2685  
 Targa 2000 Pro 2899

**MICROTEK**

ScnMkr E3 185  
 ScnMkr E6 329  
 ScnMkr E6 Pro 499  
 ScnMkr III 1299

**MEGA**

ZIP 100mb drive 135  
 JAZ 1gb drive 369  
 100mb/1gb 1279

**IXMicro**

Turbo TV 95  
 4MB PCI 249  
 8MB PCI 445

**Nikon**

ScanTouch 569  
 CoolScan II 859  
 Super CoolScan 1639

**NEWTON**

2000 SMB 909  
 2000 SMB KB 979  
 2MB / 4MB 69/139  
 Keyboard 79

**FWB®**

SldgHmr 8200 2799  
 SldgHmr 17400 4589  
 Hmr DLT 15GB 2589  
 SldgeHammer PCI UW

**MAC TO GO** Toll Free! **1-888-MAC-TOGO**  
 E-Mail: [mactogo@knl.com](mailto:mactogo@knl.com) Customer Service: 310.444.1122 Facsimile: 310.444.1130

Gov't, Schools, Fortune 500 P.O.'s Welcome. \*\* denotes Refurb prod. Visa, MC, AMAX accepted. Prices are Cash Discounted for COD Cash/Cashier Check. Prices may change without notice. Limited stock. All Sales are Final.



**1800-533-9005**

E-MAIL US AT: [COMPAMER@aol.com](mailto:COMPAMER@aol.com)

(310) 446-1771 10435 Santa Monica Blvd  
 FAX Bids  
 (310) 475-7744 LA, CA 90025  
 We are open on Saturday!

# COMPU AMERICA

"The Computer Specialist"

**Check out our WEB!!!**

**UPDATED DAILY!!!** Shipping Estimates  
 Online Ordering International Sales  
 Stock/Availability Credit/COD/Leasing  
 Color Photos No Wait! No Hold!  
 Complete Specs Completely Accurate!

[HTTP://WWW.COMPU-AMERICA.COM](http://www.compu-america.com)

Government, University, and Fortune 1000 P.O.'s are welcome! International Orders Please call (310) 446-1771

## PowerMac 8600

**SPECIAL!**



**604e WITH 256K LV2 CACHE**  
 32MB RAM  
 3 PCI SLOTS  
 2MB VRAM  
 16-BIT STEREO SOUND  
 BUILT IN VIDEO IN/OUT  
 300MHZ 604E 250MHZ 604E  
 4GIGHD 2GIG HD  
 24XCD 12XCD

**\$2599 \$2099**

## PowerBook 3400C

**SPECIAL!**



**603e WITH**  
 256K LV2 CACHE  
 16 MB RAM  
 2 PCMCIA SLOTS  
 12.1" DISPLAY  
 800X600 RESOLUTION  
 16-BIT STEREO SOUND

240MHZ 3GIGHD 12XCD **\$3699** 200MHZ 2GIG HD 12XCD **\$2699** 200MHZ 2GIG HD **\$2599**

### NEW POWERMACS!

9600/350	64/4G/24X	CALL
9600/300	64/4G/24X	2999
9600/200MP32/4GIG/CD		2999
9600/233	32/4GIG/CD	2699
9600/200	32/4GIG/CD	2399
8600/300	32/4G/24X	2599
8600/250	32/4G/24X	2099
8600/200	32/2GIG/CD	1999
7300/PEN	32/2GIG/CD	2299
7300/200	32/4GIG/CD	1699
7300/180	16/2GIG/CD	1599
6500/300	32/4G/CD	2099
6500/275	64/4G/CD/ZIP	2099
6500/250	48/4G/CD/ZIP/O	1879
6500/250	32/4G/CD/ZIP	1699
6500/225	32/3G/CD	1399
4400/200	16/1G/CD/KEY	1099
4400/200	16/2G/CD/KEY	1249

### POWERBOOKS

3500C/350	64/5G/20XCD	CALL
3500C/300	32/5G/20XCD	CALL
3500C/275	32/5G/20XCD	CALL
3400C/240	16/2G/12X/MOD	3899
3400C/240	16/2G/12XCD	3699
3400C/200	16/2G/12X/MOD	2999
3400C/200	16/2G/12XCD	2699
3400C/180	16/1.2G/12XCD	2899
3400C/180	16/1.3G	CALL
2400C/180	16/1.3G	2699
1400C/166	16/2G/CD	2399
1400C/133	16/1G/CD	2299
1400CS/133	16/1G/CD	1699
5300CS/100	16/750/MOD	1199*
5300CS/100	8/750	1099*
DUO 2300C	20/1.2GB/14.4	CALL
DUO 2300C	8/750/14.4	CALL
DUO DOCK		479

### UMAX

S900/250DP64/4G/8XCD	4195	
S900/200DP32/2G/8XCD	2495	
S900/180DP32/2G/8XCD	1995	
S900/250	32/2G/8XCD	3199
S900/233	32/2G/8XCD	2399
S900/225	32/2G/8XCD	1699
S900/200	32/2G/8XCD	1799
S900/180	32/2G/8XCD	1595
J700/150	16/2G/8XCD	1299
J700/180	16/2G/8XCD	1499
C600/240	24/2G/8XCD	1199
C600/200	16/2G/8XCD	1049
C600/180	16/1G/8XCD	999
C500/180	16/1G/8XCD	949
VISTA Astra 600-LE		149
VISTA Astra 1200-LE		299
VISTA Astra 1200-PRO		499
VISTA Astra POWERLOOKII		1199
POWERLOOK 2000		3349
MIRAGE IISEW/TRANS		3699



DIMAGE V  
 DIMAGE SCAN  
 QUICKSCAN 35

### Tektronix

PHASER 140 COLOR	369
PHASER 380X COLOR	4899
PHASER 350 LASER COLOR	2999
PHASER 380 COLOR	7899
PHASER 450 COLOR	6099
PHASER 480X COLOR	14495
PHASER 550 LASER COLOR	3999
PHASER 600 WIDE COLOR	11999



XCLAIM ULTRA VR 4 MEG  
 XCLAIM ULTRA VR 2 MEG  
 XCLAIM TV TUNER



VIEWSONIC 15GA-2	369
VIEWSONIC 15G5	339
VIEWSONIC 17PS	649
VIEWSONIC 17GS	529
VIEWSONIC 17EA	579
VIEWSONIC G1770	639
VIEWSONIC PT775	689
VIEWSONIC PT770	659
VIEWSONIC PT813	1349
VIEWSONIC P810	1249
VIEWSONIC P815	1399
VIEWSONIC G810	1099

### EPSON

STYLUS COLOR 600	269
STYLUS COLOR 800	379
STYLUS COLOR 3000	1649
EXPRESSION/636/EXEC	749
EXPRESSION/636/ART	899
EXPRESSION/636/PRO	1199



TWIN TURBO 8 MEG PCI	449
TWIN TURBO 4 MEG PCI	299
TWIN TURBO 2 MEG PCI	199

### NEC

NEC 15XV+	449
NEC 17XV+	649
NEC C500 15"	429
NEC C400 14"	329
NEC E500 15"	389
NEC E700 17"	679
NEC M750 17"	879
NEC E1100	1199
NEC P1150	1299



ZIP DRIVE 100 MEG	139
JAZZ DRIVE 1 GIG	369
ZIP CART 10 PACK	129
JAZZ CART	89

### GCC TECHNOLOGIES

GCC ELITE 600ET (10PPM)	899
GCC ELITE XL-608	2199
GCC ELITE XL-616	2399
GCC ELITE XL-808	2699
GCC ELITE XL-1208	3999

### RASTEROPS

SUPERSCAN MC-6215	569
SUPERSCAN MC-6315	679
SUPERSCAN MC-7515	949
SUPERSCAN MC-20"	1169
SUPERSCAN MC-801	1399
SUPERSCAN MC-801-HR	1649



Global Village Plat 33.6 Voice	89*
Global Village Gold II PCM 14.4	49
Global Village Gold II 14.4EXT	49
Global Village 56.6 EXTERNAL	169
Global Village 56.6 PCMCIA	239
Global Cillage 56.6 ETH/PCM	359

### POWERMAC

7200/75	8/500/4XC	699*
7200/90	8/500/4XCD	749
7200/120	16/1.2G/8XCD	999*
7200/120	16/1.2G/DOS	1299*
7600/120	16/1G/4XCD	1299*
7600/132	16/1G/CD	1399*
8500/120	16/2G/4XCD	1499*
8500/132	16/1.2G/4XCD	1599*
8500/150	16/2G/8XCD	1699*
8500/180	32/2G/8XCD	1799*
9500/132	16/2G/8XCD/V	CALL
9500/150	16/2G/4XCD/VID	CALL
9500/200	32/2G/8XCD	1999*
9500/180	MP 32/2G/8XCD	2299
8100/100	8/700	999*
8100/100	16/1GIG/CD	1399*
8100/110	16/2G/4XCD	1499*

### PERFORMAS

6400/200V	16/2.4G/CD	1399*
6400/200	16/2.4GIG/CD	999*
6400/180	16/1GIG/CD	899*
6320/120	16/1GIG/CD	799*
6300/100	16/1.2G/4XCD	749*
6360/160	16/1.2G/8XCD	799*
6220/75	16/1G/CD/TV	649*
6200/75	8/1GIG/4XCD	599*
6116/66	8/700/4XCD	599*

### WorkGroup Servers

7350/180	48/4G/CD/SHA	2999
7350/180	48/4G/CD/INT	2799
7350/180	48/4G/CD	2499
500/132	32/1G/CD	6299
700/150	32/1G/CD	7399
700/200	48/2G/CD	995
9650/350	64/4GIG/CD/INT	CALL
9650/300	64/4G/CD/SHAR	CALL
9600/300	64/4GIG/CD/DAT	CALL
9650/233	64/4G/CD/SHA	5499
9650/233	64/4G/CD/INTER	4799
9650/233	64/4G/CD/DAT	5099

### Software Specials

ADOBE PHOTOSHOP	394
ADOBE PREMIER	349
ADOBE ILLUSTRATOR	294
ADOBE PAGEMILL	99
ADOBE PAGEMAKER	499
MACROMEDIA FREEHAND	299
MICROSOFT ACCESS	199
MICROSOFT WORD	249
MICROSOFT EXCEL	249
MICROSOFT POWERPOINT	199
MICROSOFT OFFICE	399
MICROMOTION DC30	779
QUARK XPRESS	639

### SONY

Sony 100SF/100SX	339/329
Sony 200SF/200SX	629/549
Sony 300SF	1299

### WACOM

ARTZ II 4 X 5	139
ARTZ II 6 X 8	295
ARTZ II 12 X 12	399
ARTZ II 12 X 18	679

### HEWLETT PACKARD

5SIMX	3499
5M	1499
5MP	599*
6MP	829
4MV	2299
Deskjet 680C	279
Deskjet 870CXI	389

### radius

PRECISION VIEW 21"	1499
PRESSVIEW 21SR	2699
Thunder 30/1600	499
Thunder color 30/1600	1699
Thunder Power 30/1600	799
Thunder Power 30/1920	999
Thunder 3D 1600 x1200	2499
VIDEO VISION STUDIO 2.0	2899
SupermatchTXL w/Calibrator	999*

All prices are cash discounted. Prices subject to change without notice. Not responsible for typos. An asterisk "\*" denotes refurbished product.

CIRCLE 410 ON READER SERVICE CARD



# DFI

### 20" Sony Color BLOWOUT MODEL!

Model GDM1960 SuperFine Pitch Trinitron Tube .28 DP

• 1 Year Warranty  
1024 x 768 Refurbished

• Tilt Swivel Base  
Only **\$649!**

We also carry 17" Sony Monitors as low as **\$299**

Call for Details **800-390-7020**

181 Salem Street, Malden, MA 02148



CIRCLE 414 ON READER SERVICE CARD

## Macintosh Specialists

### 12X CDROM SCSI

**\$99** \*external \$129

### HP 5MP (R) 600 dpi LaserJet

**\$549** \*toner add \$10

### System 8.0 Complete Upgrade

**\$52.99** Mac OS or 7.6 CD \$19.99

### 17" Color (R) Trinitron™ Blowout

**\$249** \*Hi-Res \$325

Apple StyleWriter 1200 w/Ink (R)	89.00	20" Trinitron™ Monitor (R)	649.00
Epson Stylus 600 (N)	279.00	17" PowerComputing MS (R)	499.00
Epson Stylus 800 (N)	399.00	15" MultiScan Mtr, Black (N)	249.00
Apple LaserWriter IIxt (U)	289.00	Apple 14" MultiScan Mtr (U)	179.00
HP LaserJet 5si w/toner (N)	2149.00	Apple 13" RGB Trinitron Mtr (U)	179.00
Ext. Hard Drive Enclosure w/cable(N)	49.00	ALPS Trackpad, Mac ADB (N)	19.50
40MB 3.5" x 1", SCSI (N)	25.00	ADB Mouse, Single Button, Mac (N)	16.50
2 GB 3.5" x 1", 7200av, SCSI (R)	199.00	Extended Keyboards, Mac ADB (N)	39.00

### PACKAGE DEALS

Color Monitor, Ext Keyboard, New Drive, New Mouse and SW1200 Ink-Jet Printer.	
Mac II 4/40 PACKAGE	269.00
Mac IIsi 5/160 PACKAGE	369.00
Mac IICI 4/160 PACKAGE	469.00

### BUY/SELL/LEASE

We accept... School & Gov't POs • V/MC/AMEX/DISC  
**800-673-6227**

PowerON computer services • 4323 Anthony Ct. #1 • Rocklin, CA 95677

# www.poweron.net

Prices subject to change without notice. All Prices include 3% cash discount.

(916) 652-1880 • (916) 652-1881 FAX Mon.-Sat. 10a-5p PST

CIRCLE 419 ON READER SERVICE CARD

## USED MACINTOSH!



- We match buyers and sellers of used MAC equipment!
- All MAC models available; SE to POWER PC.
- All hardware is tested and includes a limited warranty.
- Qualifying School, Gov't and Fortune 1000 POs Welcome
- We also specialize in used trade-ins

### The Computer Exchange

**800-304-4639**

www.compexch.com

Ph: 404-315-0897

Fax: 404-315-7840

2100 Cheshire Bridge Rd Ste E Atlanta, GA 30324

CIRCLE 438 ON READER SERVICE CARD

# 1-800-334-KIWI

## Kiwi Computers • Save on refurbished Macs

### Performas

630/12/1.2 Gig 4xCD	\$449
6200/75 8/1 Gig 4xCD	\$599
6300/100 16/1.2 Gig 4xCD 28.8	\$749
6360/160 16/1.2 Gig 8xCD 28.8	\$835
6400/180 and 6400/200	Call
5200/75, 5300/100, 5400/200	Call

### Power Macs

7600/132 16/1.2 Gig 8xCD	\$1475
8500/180 32/2 Gig 8xCD	\$2099

### Motorola Starmax

4000/160 604e Desktop 16/1.2 Gig 8xCD	\$1049
4000/200 604e Minitorver 32/2.5 Gig 8xCD	\$1449

### Memory

16mb 72 pin SIMM	\$45
32mb 72 pin SIMM	\$92
16mb, 32mb, 64mb 168 pin DIMM	Call

Visa/Mastercard/American Express No Surcharge.

Refurbished products have a 90 day warranty • Returns subject to a 15% restocking fee • Prices subject to change without notice.

Toll Free: 800-334-5494 International: 310-553-4507 Fax: 310-286-9667

Hours: Mon-Fri 8am to 6pm, Sat 9am to 2pm • Better Business Bureau Member

Kiwi Computers, P.O. Box 67381, Los Angeles, CA 90067

CIRCLE 420 ON READER SERVICE CARD

## PACIFIC COMPUTER EXCHANGE

### Used Macs Priced to Move

6300/100 16/1Gig CD	\$799	Color Classic	\$499
7100/66 8/250	\$699	Powerbook 190cs	\$1099
6100/66 8/500 CD	\$599	PB 540c 12/320 19.2 modem	\$1399
Quadra 840AV	\$599	Powerbook 520 / 520c	\$899 / \$999
Centris 650/660AV	\$499	Powerbook 180/180c	\$799 / \$899
Quadra 650	\$599	Powerbook 160/170	\$599
Quadra 700	\$399	Powerbook 145/150	\$499
Quadra 610/630	\$429/469	LaserWriter IIg	\$599
IIcx/IIvx	\$299	LaserWriter IIxt/ntx	\$299 / \$399
IIsi/IIcx	\$249	HP DeskWriter	\$159
LC/LCII/LCIII	\$199/249/299	Apple StyleWriter 2400	\$179
SE/SE30	\$199/349	ImageWriter II	\$159
Classic/ClassicII	\$199/299	NEW MultiMedia Speakers	\$39

Cash paid for your Mac via Fed Ex!

800.790.3881 ORDERS & PURCHASING INFO

We buy and sell used Macs!

SPECIAL!

Media Vision Refurbished 2X External CD ROM for Powerbooks \$ 79

NEW!! 14.4 Internal Modem for Powerbook 100 Series \$ 79

CIRCLE 434 ON READER SERVICE CARD



**HAWKE**  
BUSINESS SYSTEMS  
A Division of the CPS Services Group  
Flemington, NJ 08822

(800) 875-2610

Fax - (908) 782-7027

Email - MacHawke@AOL.COM

### Specialist in Refurbished Macintosh Equipment

Visit Our New Web Site - www.MacHawke.com - for Full Listing

Systems	Service Parts	Peripherals
Classic 4/40 w/ K&M - \$199.00	1.4 Meg Floppy Drive - \$79.00	Hp DeskWriter - \$79.00
Classic II 4/80 w/ K&M \$325.00	Se & Se/30 Power Sup \$29.00	StyleWriter II - \$99.00
Se/30 8/80 w/ K&M - \$325.00	Mac II, IIx, IIEx P/S - \$49.00	StyleWriter 1200 - \$129.00
	Mac Classic P/S - \$69.00	LaserWriter II Nt - \$349.00
	Apple 8 bit Video Brd - \$59.00	LaserWriter IIG - \$499.00
	EtherNet - Nubus RJ45 - \$39.00	LaserWriter Pro630 - \$699.00
	Mac IISI Nubus Adpt - \$49.00	
	Logic Board Exchange & Repair	Apple Portrait Mon - \$199.00
Quadra 650		Apple Hi Res Color - \$225.00
PM 6100/60		Apple 15" MultiScan \$289.00
PM 6205/ 75		Apple 17" Multiscan \$449.00
All Color Packages include Apple Color Monitor, ExtKvb & Mouse	6 Month Parts and Labor System Warranty	Apple 21" Color Mon - \$999.00

CIRCLE 412 ON READER SERVICE CARD



# CALL THE MAC EXPERTS!

Providing complete Macintosh solutions for graphics, pre-press, and video professionals

**PACKAGE DEAL BLOWOUT! ORDER ONE OF THESE COMPLETE SYSTEMS TODAY, OR CUSTOMIZE IT YOUR WAY!**

### Package 62W981

Factory Refurbished Performa 6220: 75 MHz w/24 Mb RAM, 1 gig drive, TV capture card, modem, 15" color display, commercial surge protector. Only **\$1088**, or just **\$43 per month!**



Only while supplies last!

### Package 64W981

Factory Refurbished Performa 6400/200: 200 MHz w/24 Mb RAM 2.4 gig drive, Geoport modem, commercial surge protector, 2 game CD set w/Descant, Blackthorn & more! Only **\$1499** or just **\$60 per month!**



Pictures may not match monitor in package

### Package 63W981

Factory Refurbished Performa 6320: 120 MHz w/24 Mb RAM, 1 gig drive, TV capture card, 28.8 modem, 15" color display, commercial surge protector. Only **\$1288**, or just **\$52 per month!**



### Package 5M6W981

SuperMac C600LT: 240 MHz w/40 Mb RAM, 2 gig drive, 15" color display, Astra 600S scanner w/PhotoDeluxe & Photoshop 2.5LE, commercial surge protector. Only **\$1799**, or just **\$72 per month!**



### Package 65W981

PowerMac 6500: 250 MHz w/48 Mb RAM, 4 gig drive, 12x CD, 15" color display, Astra 600S scanner w/PhotoDeluxe & Photoshop 2.5LE, commercial surge protector, **\$2488**, or just **\$99 per month!**



### Package S9W981

SuperMac S900/233 with 96\* Mb Ram, 4 gig drive, 12x CD-rom, int. Zip drive, 17" PowerMax Trinitron monitor, 8 Mb video card, commercial surge protector. Only **\$3588**, or just **\$137 per month!**

## PowerMax Trinitron™ Monitors

Model PM15T 25 mm dot pitch- up to 1280x1024	.....	<b>\$359</b>
Model PM17T 25 mm dot pitch- up to 1280x1024	.....	<b>\$649</b>
Model PM17TE+ 25 mm dot pitch- up to 1600x1280	.....	<b>\$849</b>
Model PM20T 30 mm dot pitch- up to 1600x1280	.....	<b>\$1449</b>
Model PM20T+ w/ 25 mm dot pitch!	.....	<b>\$1649</b>

PowerMax Trinitron™ monitors are designed specifically for the rigorous demands of the Macintosh. They ship complete with Mac-ready cables and adapters, a three year warranty, and our satisfaction guarantee: if the monitor is not just right, we'll replace it for you!



priced!" and "Nice price, nice image quality, nice controls - nice monitor!"

### MacUser Labs Said:

"Four Mice! A PowerMax Power Play" and "Not only do the PowerMax monitors display good-looking images, but (they) are affordably

Ask about our complete Apple PowerPC systems with monitor for under \$900!

### Ready-Made Mac Systems

Performa 4400/200 16/1 Gig/8x	.....	<b>\$1229</b>
Performa 4400/200 PC Compatible	.....	<b>\$2177</b>
PowerMac 6500/225 32/3000/33.6 Mod	.....	<b>\$1549</b>
PowerMac 6500/250 32/4000/24x/Mod	.....	<b>\$1955</b>
PowerMac 6500/250 48/4000/12x/Zip/Mod	.....	<b>\$1955</b>
PowerMac 6500/275 32/4000/12x/Zip	.....	<b>\$2365</b>
PowerMac 6500/300 64/4000/12x/Modem	.....	<b>\$2399</b>
PowerMac 6500/275 32/6000/24x/Zip	.....	<b>\$2445</b>
PowerMac 6500/275 48/6000/24x/Zip	.....	<b>\$2739</b>
PowerMac 6500/300 64/4000/12x/Modem	.....	<b>\$2399</b>
PowerMac 6500/300 64/6000/24x/Zip	.....	<b>\$2969</b>

### Customizable Mac Systems

PowerMac 7300/180 16 Ram/12x/KB	.....	<b>\$1599</b>
PowerMac 7300/200 16 Ram/12x/KB	.....	<b>\$1749</b>
PowerMac 8600/250 32 Ram/24x/0 Zip/KB	.....	<b>\$2128</b>
PowerMac 8600/250 32 Ram/24x/Zip/KB	.....	<b>\$2238</b>
PowerMac 7300/180 Pentium System	.....	<b>\$2899</b>
PowerMac 8600/300 32 Ram/24x/0 Zip/KB	.....	<b>\$2599</b>
PowerMac 8600/300 32 Ram/24x/Zip/KB	.....	<b>\$2699</b>
PowerMac 9600/200 32 Ram/12x/KB	.....	<b>\$Call!</b>
PowerMac 9600/233 32 Ram/12x/KB	.....	<b>\$2648</b>
PowerMac 9600/300 64 Ram/24x/KB/0 Zip	.....	<b>\$3288</b>
PowerMac 9600/300 64 Ram/24x/KB/Zip	.....	<b>\$3388</b>

Powerbooks! Powerbooks! Powerbooks! We stock all the 1400's, 2400's & 3400's at super low prices!

### Umax SuperMac Compatibles

SuperMac C500/200 16/2 Gig/CD/"Lite"	.....	<b>\$995</b>
SuperMac C500/200 16/2 Gig/CD/33.6 Mod	.....	<b>\$1095</b>
SuperMac C600/200 16/2 Gig/CD/33.6 Mod	.....	<b>\$1195</b>
SuperMac C600/240 24/2 Gig/CD/33.6 Lite	.....	<b>\$1395</b>
SuperMac C600x/240 32/3 Gig/12x/CD/33.6	.....	<b>\$1795</b>
SuperMac C600x/280 32/4 Gig/12x/CD/33.6	.....	<b>\$2149</b>
SuperMac J700 24/2 Gig/12x/CD/33.6 Mod	.....	<b>\$Call!</b>
SuperMac S900 200 MHz - customize!	.....	<b>\$2199</b>
SuperMac S900 233 MHz - customize!	.....	<b>\$2588</b>
SuperMac S900 250 MHz - customize!	.....	<b>\$3099</b>

## PowerMax External Hard Drives



Everything you need is included!

We customize high-end arrays for all Macs!

•Atto •Micronet  
•FWB •Optima

12X External CD Rom	.....	<b>\$149</b>
24X External CD Rom	.....	<b>\$179</b>
External Jaz One Gig Removable	.....	<b>\$349</b>
2x6 CD Recorder w/Toast Software	.....	<b>\$399</b>
4x6 CD Recorder w/Toast Software	.....	<b>\$569</b>
External 1.0 Gig Seagate 5400 RPM	.....	<b>\$279</b>
External 2.0 Gig Seagate 5400 RPM	.....	<b>\$309</b>
External 2.0 Gig Quantum 5400 RPM	.....	<b>\$319</b>
External 3.2 Gig Quantum 5400 RPM	.....	<b>\$399</b>
External 4.3 Gig Micropolis 5400 RPM	.....	<b>\$449</b>
External 4.3 Gig Quantum 5400 RPM	.....	<b>\$449</b>
External 2.2 Gig Quantum 7200 RPM	.....	<b>\$499</b>
External 6.4 Gig Quantum 5400 RPM	.....	<b>\$569</b>
External 4.5 Gig Micropolis 7200 RPM	.....	<b>\$699</b>
External 4.5 Gig Seagate 7200 RPM	.....	<b>\$819</b>
External 4.5 Gig Seagate 10000 RPM	.....	<b>\$899</b>
External 8.7 Gig Micropolis 7200 RPM	.....	<b>\$909</b>

### Why Buy From PowerMax?

- Most orders ship within 24 hours- even customized systems!
- We speak plain English; you'll talk to an informative, knowledgeable person with no technolalk or high pressure sales tactics!
- We offer flexible terms, and are experts on easy leasing!
- Aggressive purchasing and high volume means low, low pricing!
- We consult with you; we want to make sure what you buy is what you need. We'll probably ask you as many questions as you ask us!
- We're based in Portland, Oregon, where the people are friendly and polite, and where there is no sales tax!

We're out of room! Call for the absolute lowest prices and immediate delivery on the following products:

**Displays:** Apple, CTX, Hitachi, InFocus, LaCie, Mag, Magnavox, Mitsubishi, NEC, PowerMax, Radius, Samsung, Sony, ViewSonic  
**RAM:** We stock lifetime-warranted RAM for every model of Mac made!  
**Software:** Adobe, Acius, Claris, Deneta, MacroMedia, Microsoft, Mindscape, Netscape, Quark, Specular, Symantec and dozens more!  
**Scanners:** Agfa, Apple, Epson, Hewlett Packard, LaCie, Linotype, Microtek, Nikon, Polaroid, Umax, Visioneer  
**Printers:** Apple, Canon, DataProducts, Epson, Fargo, GCC, Hewlett Packard, Kodak, Lexmark, NewGen, QMS, Tektronix, Xante  
**Storage:** Atto, Iomega, Kodak, LaCie, Micronet, NEC, Olympus, Optima, PowerMax, Quantum, Seagate, StreamLogic, Sony, Syquest  
**Modems:** Boca, Dayna, Global Village, Hayes, Motorola, US Robotics  
**Video:** ATI, Focus, IMS, Media 100, Miro, Number 9, Radius, TrueVision



# 800-613-2072

Local line: (503) 624-1827 • Fax (503) 624-1635  
<http://www.powermax.com> • email: [powermax@europa.com](mailto:powermax@europa.com)

Prices subject to change without notice. Prices reflect cash discount. Credit card orders strictly verified against fraudulent use. With use of credit card as payment customer acknowledges that some products are subject to final sale.

We accept educational and corporate purchase orders, and are experts in financing for virtually any size business!







**SONY, FWB  
VIEWSONIC  
NEC, NEWER TECH  
RADIUS, AGFA  
SOFTWARE TOO!**



**HP, IMS, ATI  
MIRO, TARGA  
EPSON, WACOM  
TRUEVISION  
MICROTEC**



**CUSTOM CONFIGURATIONS**

a division of **BASEONE** computers.

**LEASING PLANS AVAILABLE**



**AWESOME NEW LOOK AND FEATURES!**

**WWW.MACBASE.COM**

**Forget INACCURATE print ads! Get up to the second real time pricing.**

**POWERMAC**

CALL FOR NEW G3 MODELS!!!  
4400/200 16/1.2GB/CD CALL  
4400/200 SMALL BUSINESS 1549  
4400/200 PC COMPATIBLE 2049  
5400/180 16/2G/8XCD CALL  
6500/250 48/4GB/CD/ZIP/OFF 1899  
6500/250 32/4G/24X/ZIP/HM 1899  
6500/275 48/6G/24X/ZIP/OFF 2599  
6500/275 32/6G/24X/ZIP/HM 2349  
6500/275 CREATIVE STUDIO 2249  
6500/300 64/6G/24X/ZIP/HM 2789  
7200/90 8/500/CD REF 699  
7300/180 16/2GB/CD 1699  
7300/200 DOS 32M/16D/2GB CALL  
7300/200 32/2GB/CD 1879  
8600/200 32/2GB/CD/ZIP 2299  
8600/250 32/4G/24XCD/ZIP 2359  
8600/300 32/4GB/24XCD 2659  
8600/300 32/4GB/24XCD/ZIP 2759  
9500/132 16/1GB/CD/VI REF 1689  
9600/200 0/0/CD 1699  
9600/200 32/4GB/CD 2399  
9600/233 32/4GB/CD 2759  
9600/300 64/4GB/24XCD 3299  
9600/300 64/4GB/24XCD/ZIP 3399  
9600/350 64/4GB/24XCD CALL  
9600/350 64/4GB/24XCD/ZIP CALL  
CALL FOR PRICES ON MEMORY  
ADDONS, HD UPGRADES, AND MORE.

**SOFTWARE**

ADOBE PHOTOSHOP 4.0 379  
ADOBE ILLUSTRATOR 7.0 319  
ADOBE PAGEMAKER 379  
QUICKEN 7.0 29  
MACROMEDIA FREEHAND 329  
MACROMEDIA DIRECTOR 5.0 759  
MICROSOFT OFFICE 249  
QUARK EXPRESS 629  
APPLE MAGIC COLLECTION CD 49

**PERFORMA**

6200 CD 8/1GB/CD REF 599  
6360/160 16/1.2GB/CD/REF 999  
6360/160 16/1.2GB/CD CALL  
6400/200 16/2.4GB/CD 1299  
6400/200 VIDEO EDITION CALL  
6200 14.4 MODEM INTERNAL 20  
CALL FOR MEMORY UPGRADES, ETC.

**PRINTERS**

Apple SW 2200 /2500 289/CALL  
SW 4100/4500/6500 249/349/479  
Apple LW 12/640 1149  
Apple LW 16/600 REF 1159  
Apple LW 16/600 1489  
NEW!! Apple LW 8500/20 (20PPM)2499  
Apple LW COLOR 12/660 3799  
EPSON STYLUS 600/800 289/389  
EPSON STYLUS 1520/PROXL 789/1359  
HP 8700CI / 6MP 379/899  
HP 5M / 4MV 1549 / CALL

**MONITORS**

Apple 15" / 15AV 299/369  
Apple 1705 / 1710 529/699  
Apple 1710AV 17" 799  
AppleVision 750 / 750AV 799/949  
Apple 850 20" / 850AV 1479/1799  
NEC C400/C500/M700 279/349/759  
NEC P1150 20" 1689  
Sony 100SF/200SF 369/699  
Sony 300 SFT 1299  
VIEWSONIC 17PS 739  
VIEWSONIC GT800 1189  
VIEWSONIC P810 1399  
VIEWSONIC PT770 739  
VIEWSONIC GB10 1249  
POWER 17 INCH REF 499

**POWERBOOK**

DUO 2300C 8/750 REF 989  
DUO 2300C 8/750 1099  
DUO 2300C 20/1GB/MOD/REF 1349  
DUO 2400C 16/1.3G 2979  
DUO DOCK II PLUS 449  
1400CS/133 16/1.3GB/CD 1899  
1400C/166 16/1GB/CD 2489  
3400C/180 16/1.3GB/6XCD 2799  
3400C/180 16/1.3GB/12XCD 2959  
3400C/200 16/2GB/6XCD 3279  
3400C/200 16/2G/12X/NOMD 3199  
3400C/200 16/2G/12XCD 3499  
3400C/240 16/3G/12X/NOMD 3999  
3400C/240 16/3G/12XCD 4099  
ACTION 28.8 PCMCIA 129  
ACTION 33.6 PCMCIA 149  
APPLE CARRYING CASE 19  
GLOBAL VILLAGE 56.6K PCMCIA 259

**STORAGE**

APPLE 4GB HD 3.5 SCSI 429  
EZ QUEST JAZ EXT. W/CART 349  
EZ QUEST JAZ INT. W/CART 309  
EZ QUEST JAZ & Y4X6 CDR 599  
IOMEGA JAZ DRIVE 379  
IOMEGA ZIP DRIVE 149  
IOMEGA ZIP DR. INT. 129  
IOMEGA ZIP CART 12  
IOMEGA JAZ CART 79  
IOMEGA SCSI TO PC CONNECTOR 19  
QUANTUM 2.1GB HD 3.5 SCSI 249  
QUANTUM 4.3GB HD 3.5 SCSI 399  
QUANTUM 6GB HD 3.5 SCSI 459  
QUANTUM 9.1GB ATLAS II 999  
SEAGATE 4.5GB CHEETAH 799  
SEAGATE 9.1GB CHEETAH 1699  
SEAGATE 2.5GB BARRACUDA 429  
SEAGATE 4.5GB BARRACUDA 799  
SEAGATE 9.1GB BARRACUDA 1099  
SEAGATE 23GB ELITE 2599  
EXT. HD CASE 59

**WORKGROUP SERVER**

CALL ABOUT OUR HUBS, & ETHERNET  
7350/180 48/4GB/CD 2499  
7350/180 48/4GB/CD/WEB 2899  
7350/180 48/4GB/CD/A.S. 3059  
9650/350 16/2X4GB UW/24X 6499  
9650/350 16/2X4GB UW/CD/AS6899  
9650/350 16/2X4 UW/CD/INT 6699

**SCANNERS**

AGFA ARCUS II TRANS & PHOTO \$1579  
STUDIOSTAR 829  
STUDIOSTAR LE 719  
SNAPSCAN 300 & 600 329/399  
EPSON EXPRESSION 636 EXEC 749  
EPSON EXPRESSION 636 ART 929  
EPSON EXPRESSION 636 PRO 1269  
MICROTEK SCANMAKER E3 219  
MICROTEK SCANMAKER E6 299  
MICROTEK SCANMAKER E6 PRO 1299  
MICROTEK SCANMAKER III 1349  
NIKON COOLSCAN 20E 829  
NIKON SUPERCOOL SCAN 1629  
UMAX ASTRA 600S 195  
UMAX ASTRA 1200S 389  
POWERLOOK II PRO 1349

**VIDEO CARDS**

ATI XCLAIM 2 MB 219  
ATI XCLAIM 4 MB 309  
ATI TV TUNER 99  
ATI XCLAIM 3D 8 MB 329  
IMS TWIN TURBO 8 MB 459  
IMS TWIN TURBO 4 MB 229  
IMS TWIN TURBO 2 MB 179  
We carry the full line of 3D & Photoshop Accelerated Graphics Cards by Radius.

**Real Prices! Real Products! Real People.**

**800-951-1230**

Int'l (714) 428-0777 University, School, Government & Fortune 1000 P.O.'s Accepted! FAX (714) 428-0778



Dealers inquiries welcome. Returns subject to restocking fee. Prices reflect C.O.D. or CASH and are subject to change without notice. P.O.'s subject to approval.



CIRCLE 422 ON READER SERVICE CARD



**800-345-1234**

**DATA**

**www.datamicro.com**

**Sales: (310)-398-3300**

**Micro Computer Inc.**

**Fax: (310)-391-2488**

Dealers & International Sales Welcome

3847 Grandview Blvd.  
Los Angeles, CA 90066

**e-mail: datamicro@earthlink.com**

**PowerMacs** Sale Lease

6100/66	8/500/CD	\$649	18
6100/DOS	16/500/CD	\$849	23
4400/200	16/2GB/CD	\$1085	37
7200/120	16/1GB/CD	\$1095	30
7300/180	16/2GB/CD	\$1785	48
7300/200	32/2GB/CD	\$1849	58
7600/132	16/1GB/CD	\$1385	41
8500 & 9500 Series			CALL
8600/200	32/2GB/CD	\$2469	71
9600/MP	32/4GB/CD	\$3175	99
9600/233	32/4GB/CD	\$2749	96
9600/300	64/4GB/CD	\$3149	123
9600/350	64/4GB/CD/Zip	\$4749	143

**PowerBooks**

1400cs/117	12/750	\$1499
1400cs/117	16/750/CD	\$1749
1400c/117	16/1GB/CD	\$2295
1400c/133	16/1GB/CD	\$2395
2300c	8/750	\$995
2300c	20/1GB/Modem	\$1389
2400c/180	16/2GB	\$2489
3400c/180	16/1GB/CD	\$2789
3400c/200	16/2GB/CD	\$2879
3400c/240	16/3GB/CD	\$3789

**Performas**

6116	8/700/CD	\$695
6116/DOS	16/700/CD	\$895
5200	8/500/CD/15"	\$795
6200	8/1GB/CD	\$649
6360	16/1GB/CD	\$895
6400/180	16/1GB/CD	\$969
6400/200	32/2.4GB/CD	\$1095

**Monitors**

Apple MultiScan 14"	\$229
MultiScan 15"	\$299
1705 (17")	\$599
MultiScan 20"	\$1475
radius 15" Grayscale	\$199
Pivot 15" Grayscale	\$295
20" Grayscale	\$695
17" Color	\$645
IntelliColor 20"	\$1099
Precision 21" Color	\$1495

**Printers**

Apple LaserWriter 16/600	\$1995
LaserWriter 12/660	\$3999
LaserWriter 12/640	\$1399
LaserWriter 360	\$1249
StyleWriters	Lowest Price.
HP LaserJet LJ. 5SIMX	\$3495
LaserJet 5M	\$1495

**Scanners**

Agfa Arcus II	\$1475
Agfa Studio Star LE	\$689
UMAX PowerLook II	\$1249
EPSON Stylus 3000	\$1649

**Call for Software & Accessories not listed**

**MOTOROLA StarMax**

4000/200	32/2.5GB/CD	\$1649
5000/275	32/4.3GB/CD	\$2195
5000/300	32/4.3GB/CD	\$2349
5500/200	32/4.3GB/CD	\$2595
6000Pro/266	32/4.3GB/CD/Zip	\$4149

**UMAX SuperMac**

500/600/700 Series	CALL	
S900/200	32/2GB/CD/MP	\$1899
S900/225	32/2GB/CD	\$1999
S900/233	32/2GB/CD	\$2189
S900/250	32/2GB/CD/Zip	\$3089

**We Specialize in Business Leasing** **Government, Universities & Corporations P.O.'s are accepted**

**DIGITAL**

Media 100qx	\$2195
Bravada 1000	\$629
Targa 1000PCI	\$1789
Targa 2000PCI	\$2698
IX Micro Twin Turbo SMB	\$595
Kodak DC 25	\$459
Kodak DC 50	\$859
Apex 4.6 Optical Drive	\$1685
Raid Array Hard Disks	CALL

**MediaGuide** Prices Listed Reflect a 3% Cash Discount

**(800) 463-0686 BUY/SELL/TRADE (800) 463-0686**

<p>Mac Plus 1/0.....\$59</p> <p>SE/30 8/40.....\$149</p> <p>Mac II 4/40/Video...\$69</p> <p>Ilci 8/40/Video.....\$99</p> <p>Ilcx 8/80.....\$149</p> <p>Mac IIfx 8/160.....\$199</p> <p>Q605 8/160.....\$349</p> <p>Q630 16/250.....\$399</p> <p>Q650 16/230.....\$449</p> <p>Q800 16/230.....\$479</p> <p>Quadra 660AV 16/230/CD.....\$499</p> <p>Quadra 840AV 16/230/CD.....\$649</p> <p>6100/60 8/230/CD.....\$549</p> <p>6100/66 8/230/CD.....\$599</p> <p>7100/66 8/230/CD.....\$649</p> <p>7100/80 8/230/CD.....\$699</p> <p>8100/80 8/500/CD.....\$799</p> <p>7200/75 8/500/CD.....\$649</p> <p>7200/90 8/500/CD.....\$749</p> <p>7500/100 16/1gig/CD.....\$1199</p> <p>Other Power Macs in stock.....CALL!!</p> <p>PB 140 4/40.....\$299</p> <p>PB 145 8/40.....\$399</p> <p>PB 170 8/40.....\$499</p> <p>PB 160 8/80/14.4.....\$529</p> <p>Powerbook 165 14/160/14.4.....\$599</p> <p>Powerbook 180 12/120/14.4.....\$699</p> <p>Powerbook 180c 10/240/14.4.....\$899</p>	<p>SE 4/40.....\$79</p> <p>Classic 4/40.....\$119</p> <p>LC 4/40.....\$119</p> <p>Ilsi 5/40.....\$99</p> <p>Ilx 8/80/Video.....\$119</p> <p>Ilvx 8/160.....\$179</p> <p>Q610 16/500.....\$399</p> <p>C650 16/230.....\$399</p> <p>Q700 8/230.....\$399</p> <p>Q900 8/230.....\$499</p> <p>Duo 230 12/120/14.4.....\$499</p> <p>Duo 270c 12/240/14.4.....\$699</p> <p>Duo 280 12/120/14.4.....\$649</p> <p>Duo 280c 24/320/14.4.....\$799</p> <p>Apple Duo Dock II.....\$299</p> <p>Powerbook 190 8/500.....\$799</p> <p>Powerbook 520 12/160/19.2.....\$799</p> <p>Powerbook 520c 12/160/19.2.....\$899</p> <p>Powerbook 540c 12/320/19.2.....\$1099</p> <p>Powerbook 1400-series.....BEST PRICES!</p> <p>Powerbook 5300-series.....LOWEST!</p> <p>Apple 12" Mono.....\$89</p> <p>Apple 13" RGB.....\$149</p> <p>Apple 15" MS.....\$299</p> <p>Apple 17" MS.....\$499</p> <p>Assorted 20" Color monitors.....from \$399</p> <p>Imagewriter II.....\$99</p> <p>Laserwriter IInt.....\$199</p> <p>Laserwriter IIf.....\$299</p> <p>LW Pro 630.....\$699</p> <p>Imagewriter LQ.....\$99</p> <p>External hard drive case w/cable.....\$29</p> <p>Seagate 2 gig int. hard drive (8.5ms).....\$279</p> <p>New Apple 8x CD-ROM.....int. \$99 / ext. \$149</p> <p>Apple Extended Keyboard II.....\$39</p> <p>HDI45 video cable for 6100/7100/8100.....\$25</p>	<p><b>• PARTS 'N MORE •</b></p> <p>Logic boards:</p> <p>Plus.....\$29</p> <p>Classic.....\$59</p> <p>Ilcx/Ilsi.....\$49</p> <p>Power supplies:</p> <p>Mac II, IIfx, IIfx.....\$29</p> <p>LC, 475, 605.....\$29</p> <p>Ilcx, IIfx, 650, 7100.....\$49</p> <p>SE, SE/30.....\$29</p> <p>Mac Plus analog board.....\$39</p> <p>Nuts 'n Gum.....together at last!!</p> <p>8-bit NuBus video card.....\$39</p> <p>NuBus ethernet.....\$29</p> <p>Ilsi or SE/30 ethernet card.....\$39</p> <p>NEW ADB mouse.....\$25</p> <p>NEW Global Village 14.4 PCMCIA.....\$59</p> <p>Digital video in/out cards.....from \$199</p> <p>VideoVision Studio (NuBus).....\$799</p> <p>800k floppy.....\$25</p> <p>1.44 floppy drives from only \$69</p> <p>Powerbook parts &amp; much more.....CALL!</p> <p>1MB VRAM.....\$21</p> <p>1mb 30-pin SIMMS.....\$5</p> <p>Astound 1.0.....\$25</p> <p>OmniPage Pro 5.0.....\$79</p> <p>MS Excel 4.0.....\$49</p>	<p><b>"SPICIER-HOT" BUNDLE SPECIALS:</b></p> <p>Mac IIfx 8/80, Apple 13" RGB, Ext. KB, mouse...\$299</p> <p>Mac IIfx 8/80, Apple 13" RGB, Ext. KB, mouse...\$329</p> <p>Mac Ilsi 5/80, Apple 13" RGB, Ext. KB, mouse...\$249</p> <p>Mac IIfx 8/80, Apple 13" RGB, Ext. KB, mouse...\$249</p> <p><b>BUNDLE-ICIOUS!</b> Add a 13" RGB and ext. keyboard to any CPU for only \$149</p>	<p>Santa Loves Ya...ho ho ho:</p> <p>Stylewriter 1200 \$69</p> <p>Plaintalk microphone \$7</p> <p>NEW Global Village 14.4 internal for PowerBk 1xx \$39</p> <p>256K L2 cache for 6100/7100 \$12</p> <p>120Mhz 604 daughtercard for 7500's \$25</p>
---	--	---	---	--

Fax: (303) 788-0651 • Local & Int'l: (303) 788-1400  
Hours: M-F 8-6, SAT 10-5 MST • 777 N. Santa Fe Dr., Denver, CO 80204  
Sales@MediaGuide.com • Purchasing@MediaGuide.com • http://www.mediaguide.com





# Macintosh Systems & Peripherals

## Guaranteed Low Prices • Huge Inventory

### Celebrating Over 10 Years in Business at the Same Location



## \*\* SOFTWARE \*\*

- Full Retail Versions • Not Upgrades
- Adobe Pagemaker 6.5 289
- Adobe Illustrator 7.0 299
- Adobe PhotoShop 4.0 325
- Microsoft Office 4.21 259
- MacroMedia Freehand 7.0 299

## POWERBOOKS POWERMACS



- Targus Carry Case \$39
- 33.6 Fax Modem Card \$149
- 33.6 Modem/Ether Card \$299
- 10BT Ethernet Card \$99
- 56k Fax Modem Card \$265
- 56k Modem/Ether Card \$345



Custom Configurations Available  
All Systems are New with Full Manufacturer Warranty  
We will Match or Beat any verified Competitors Price

Call For Unlisted Items Over 2500 Macintosh Products Available

## Storage Products

- Omega Zip Drive 139
- Omega Jazz Drive 1GB 375
- Omega Jazz Drive 2GB 579
- Syquest Stryte 1.5 GB 379
- La Cie 2.1 External 349
- La Cie 4.3 AV External 499
- Seagate Hawk 2 GB 249
- Quantum 4.5 Atlas 649
- Seagate 9 GB Barricuda 1199
- La Cie 9GB AV External 1199
- LaCie 18GB Raid Array 2950
- Atto Express PCI Wide 359
- JackHammer PCI Wide 379

- 1400cs/133 16- 1.3 GB 8xCD 1739
- 1400c/ 133 16- 1.3 GB 8xCD 2348
- 1400c/ 166 16- 2 GB 8xCD 2609
- 2400c/ 180 16- 1.3 GB 2650
- 3400c/ 180 16- 1.3 GB 12xCD 2783
- 3400c/ 200 16- 2 GB 12xCD 3305
- 3400c/ 240 16- 3 GB 12xCD 3914

- 6360/160, 16-1.2G - 8x - Mdm 799
- 6400/200, 16-2.4G - 8x - Mdm 1125
- 4400/200, 16-2 GB - 12x - Mdm 1185
- 4400/200, 32-2 GB - 12x - Mdm 1285
- 4400/200, PC Comp 32-2 G -12x 2087
- 6500/225, 32-3 GB -12x - Mdm 1399
- 6500/250, 32-4 GB -12x - Mdm-Zip 1545
- 6500/250, 32-4 GB -24x - 56k-Zip 1739
- 6500/275, Creative Studio Bundle 2174
- 6500/275, 32-6-24xCD-56k-Zip 2174
- 6500/275, 48-6-24xCD-56k-Zip 2435
- 6500/300, 64-4-12xCD-Mdm- Zip 2345
- 6500/300, 64-6-24xCD-56k-Zip 2599
- 7300/180, 16-2GB - 12xCD 1739
- 7300/200, 32-2GB - 12xCD 1899
- 8600/250, 32-4GB - 24xCD - Zip 2261
- 8600/300, 32-4GB - 24xCD - Zip 2696
- 9600/200 MP, 32-4GB -12xCD 2799
- 9600/300, 0 - 0 - 24xCD 2425
- 9600/300, 64-4GB - 24xCD - Zip 3305
- 9600/350, 64-4GB - 24xCD - Zip 4697

## Scanners & Cameras

- Apple Color Quick Cam 200 585
- Agfa SnapScan 3D 299
- Agfa Arcus II w/transp. 1585
- Epson Express 636 Exec 849
- Epson Expression 636 Pro 1239
- Hewlett Packard ScanJet 4C 699
- Kodak DC 25 / 50 /120 389/649/939
- Linotype LinoColor Jade 499
- Microtek ScanMaker E3 / E6 185/329
- Microtek ScanMaker III 1195
- Nikon CoolScan II 859
- Olympus D200L 549
- SprintScan 35LE/35ES/35+ 759/1429/1765
- Umax Astra 600S / 1200S 185/399
- Umax 1200S Pro with PS 4.0 589
- Umax Powerlook II Pro 1249
- Umax Powerlook 2000 3799

## PRINTERS



- Apple SW 4100 / 4500 239 / 335
- Apple SW 6500 459
- Apple LW 4-600 745
- Apple LW 12-640 1275
- Apple LW 8500 (20 ppm) 2225
- Apple Color LW 12-660 5450
- Epson Color Stylus 600 285
- Epson Color Stylus 800 399
- Epson Color Stylus 1520 739
- Epson Color Stylus 3000 1769
- Epson Color Stylus Pro XL 1389
- Hewlett Packard 870CSI 389
- Hewlett Packard 6MP 885
- Hewlett Packard 5M 1555
- Hewlett Packard 4MV 2495
- Tektronix Phaser 140/ 350 925/ 2765
- Tektronix Phaser 550 8099

## MONITORS

- Apple 15" AV Display 369
- Apple 17" 1705 / 720 525 / 599
- Apple 17" 750 / 750AV 789 / 875
- Apple 20" 850 / 850AV 1649 / 1775
- Nec 15" M500 379
- Nec 17" M700 745
- Nec 21" P1150 1499
- Radius 17" PressView 17SR 1695
- Radius 21" PressView 21SR 2899
- RasterOps 21" MC801HR 1739
- Sony 15" 100SX / 100SF 310 / 369
- Sony 17" 200SX / 200SF 589 / 635
- Sony 20" 300SFT 1325
- ViewSonic 17" EA / GA 599 / 675
- ViewSonic 17" PT 770 / 775 689 / 789
- ViewSonic 21" GT810 / PT815 1455 / 1649

## New G3 PowerMac's

- 7700/200, PPC 750 32-2G - 24x 1825
- 7700/233, PPC 750 32-4G - 24x 2465
- 7700/266, PPC 750 32-6G - 24x 2999

## MOTOROLA CALL CLEARANCE SALE MEMORY UPGRADES

- TECHWORKS - LIFE TIME WARRANTY
- 8 Meg Dimms & Simms 60ns 45
- 16 Meg Dimms & Simms 60ns 89
- 32 Meg Dimms & Simms 60ns 115
- 64 Meg Dimms 219
- PB 1400 8 / 16 / 24 75 / 99 / 185
- PB 1400 32 / 48 Modules 199 / 355
- PB 2400 16 / 32 Modules 119 / 199
- PB 3400 16 / 32 / 48 99 / 195 / 315
- PB 3400 64 / 128 Modules 389 / 735

## Video / Graphics

- TwinTurbo - 4 / 8 Meg 299 / 499
- #9 Imagine 128 8 Meg 749
- Xclaim VR - 2 / 4 Meg 199 / 299
- ThunderPower 30/1600 829
- Miromotion DC20 599
- Miromotion DC30 675
- Targa 1000 / 2000 1575 / 2985
- Targa 2000 PRO 3375
- VideoVision Studio 2.0 2299

## RCD & Optical Drives

- Fujitsu Dynamo 640 489
- FWB Hammer Dat 8000 1199
- Olympus 2.6 Power MO 1699
- Pinnacle Vertex 2.6 995
- Pinnacle Apex 4.6 1425
- VST 230 MB PB1400 425
- Yamaha CD 4X6 w/Toast 699

## Leasing

On Approved Credit to... Business and Individuals

Small Business Internet Solution only

**\$1625** **\$59** per mo.

4400/200 32 Mogs, 2 Gig 12xCD, 56k Modem  
15" AV Display, Ext. Keyboard & Mouse  
Microsoft Office, Web Workshop, Business Phone  
56k Fax Modem, Internet Connection Kit  
Netscape 3.0, Claris E-Mail Software, AOL

## Home-Work and Fun!

**\$2015** **\$68** per mo.

6500/225 32 Mogs Ram, 3G HD, 12xCD  
15" AV Display, Ext. Keyboard & Mouse  
SW 4100 Color Printer, 33.6 Fax Modem  
Internet Connection Kit, Quicken, Claris Works  
Touchbase / Date Book Pro, Encyclopedia  
3-D Atlas, Dictionary, Mayo Family Health  
Clip Art, 3-D Accelerated Games, and much more!

## Graphics Station

Speed Demon w/Adobe Bundle **\$4299**

**\$145** per mo.

8600/300 64 Mogs Ram, 1 MB L2 Cache  
24xCD Player, ATI 4 MB Accelerated Video  
Iomega Zip Drive, Apple 17" Display  
Apple Extended Keyboard & Mouse  
Adobe PhotoShop 4.0, Adobe PageMaker 6.5  
Adobe Illustrator 7.0

Cyber Shop & Product Info at... [www.digicore.com](http://www.digicore.com)

# DigiCore

Order Toll Free **800-858-4622** International & Dealers **818-785-2800**  
24 Hour Fax **818-785-3100**  
15500 ERWIN ST. VAN NUYS CA 91411

36 Month Lease w/Purchase Option				
\$2500	\$4000	\$8000	\$15,000	\$25,000
\$85	\$136	\$267	\$496	\$825

GE ON-SITE WARRANTY 2nd - 4th Year			
\$700 - \$1200	\$1201 - \$2000	\$3001 - \$4000	\$4001 - \$5000
\$129	\$159	\$219	\$249

\* Lease rates listed are for businesses - call for Individual rates • Leasing is O.A.C. • Prices listed are C.O.D. • Pricing & Availability subject to change • Call for best Price • Returns Require DigiCore RMA •





# YOUR BEST BUY

VISIT US ON THE NET AT [www.applemacnet.com](http://www.applemacnet.com)

- 1-CONSULT UPDATED PRICES! 2-ONLINE CATALOG, OFFERS & ORDERING 3-CREDIT CARDS, C.O.D., P.O. & LEASING  
4-CUSTOMER SERVICE 5-WORLDWIDE SHIPPING ON THE FLY 6-SCHOOLS, UNIVERSITIES & US GOVERN. WELCOME

## Power Macs

4400	200MHz/16MB/2GB/8XCD	\$999.00
7300	200MHz/16MB/2GB/12XCD	\$1,789.00
7300PC	200MHz/16MB/2.0GB/8XCD	\$2,599.00
8600	250MHz/32MB/4GB/12XCD/ZIP	\$2,399.00
8600	300MHz/64MB/4GB/Zip Drive/24XCD	\$2,699.00
9600	300MHz/64MB/4GB/24XCD	\$3,299.00

Buy a PowerMac and Add the Office Solution!

Microsoft Office 4.2.1 + 16MB Memory For Only \$299

**Power Mac 6500 series**

6500	225MHz/32MB/3GB/12XCD/33.6Mdm	\$1,499.00
6500	250MHz/32MB/4GB/12XCD/33.6Mdm/Zip drive	\$1,759.00
6500	250MHz/48MB/4GB/12XCD/33.6Mdm/Zip(Office)	\$2,099.00
6500	275MHz/32MB/4GB/12XCD/33.6Mdm/Avid cinema	\$2,399.00
6500	300MHz/64MB/4GB/12XCD/33.6Mdm/Zip drive	\$2,399.00

**PowerBooks**

1400cs	133MHz/16MB/1.3GB/8XCD/128 k L2	\$1,899
1400c	133MHz/16MB/2GB/8XCD/128 k L2	\$2,499
1400c	166MHz/16MB/2GB/8XCD/128 k L2	\$2,389
2400c	180MHz/16MB/2GB/8XCD/128 k L2	\$2,999
3400c	200MHz/16MB/2GB/12XCD/33.6 modem	\$3,099
3400c	240MHz/16MB/3GB/12XCD/33.6 modem	\$3,699

**Apple Servers**

1-AppleShare IP 5.0 advanced server soft. that enables you to incorporate a server into a Intranet easily to take full advantage of Internet technology & more

7250	120MHz/16MB/2GB/8XCD	\$1,399.00	\$1,699.00
7350	180MHz/48MB/4GB/12XCD	\$2,499.00	\$2,799.00
9650	233MHz/64MB/8GB/12XCD	\$4,599.00	\$5,299.00

YInternet Solution Includes: Claris Home Page, Open Door LogDoor, Apple MacDNS, NetClock, Netscape, BBEdit, WebSTAR/SSL, GO live/CyberStudio, Butler SQL & more

## UMAX COMPUTERS

C600	180MHz/16MB/1GB/8XCD/33.6	\$1009
C600L	180MHz/16MB/1.2GB HD/8XCD	\$1029
C600L	200MHz/16MB/2.1GB HD/8XCD	\$1099
C600L	240MHz/24MB/2.1GB HD/8XCD	\$1449
C600L	200MHz/32MB/2.1GB HD/12XCD	\$1599
C600L	240MHz/32MB/2.1GB HD/12XCD	\$1699
C600L	280MHz/32MB/4GB HD/12XCD	\$2099
C600X	240MHz/32MB/3GB HD/12X/33.6	\$1799
C600X	280MHz/32MB/4GB HD/12X/33.6	\$2099
J700	180MHz/24MB/2.1GB HD/CD/33.6	\$1599
S900	200MHz/32MB/2.1GB HD/CD/33.6	\$2399
S900	233MHz/32MB/2.1GB HD/CD/33.6	\$2799
S900	250MHz/32MB/2.1GB HD/CD/33.6	\$3199
S900/DP	250MHz/64MB/4GB HD/CD	\$5999

Call for latest prices and promo

## Memory

### Super Hot Deal

**32MB RAM \$89**

SIMMS		DIMMS	
8MB	\$25	8MB	\$33
16MB	\$45	16MB	\$53
32MB	\$89	32MB	\$99
64MB	\$199	64MB	\$189
		128MB	\$699

## Modems

**Supra 33.6**

**\$89**

Global Village Teleport 56Kbps	\$149.00
Supra Supra Express 56e w/ speaker	\$139.00

**U.S. Robotics Modem**  
56K 2X Tec.  
For Only **\$139**

**Quick Cam**

The Ideal Digital Video Tool

**\$199**

- Animate WebPages
- Videoconference
- Millions of colors
- Internet videochat and a lot more..

## Monitors

**Apple 15AV** **\$389.**

**Viewsonic 17EA 17"AV** **\$513.**

Apple Multiscan 750	\$789.00
Multiscan 750AV	\$889.00
Multiscan 850 20"	\$1,499.00
Multiscan 850AV 20"	\$1,659.00

**Sony 17" 200SX** **\$589.**

Sony 100SX 15"	\$339.00
100SF 15"	\$369.00
200SX 17"	\$589.00
200SF 17"	\$669.00
300SF 20"	\$1,299.00
SE2 20"	\$1,699.00

3 Year Warranty

## Printers

**Apple Stylewriter 1500**

**\$139.**

Apple Color Stylewriter 2500	\$199.00
Laserwriter 4/600	\$679.00
Laserwriter 12/640	\$1,199.00

**Epson**

Stylus Photo	\$449.00
Stylus Color 600	\$285.00
Stylus Color 800	\$409.00
Stylus Color 1520	\$729.00
Stylus Color PRO XL	\$999.00
Stylus 3000	\$1,699.00

**HP**

DeskJet 340c	\$269.00
--------------	----------

## Epson Stylus 800

**\$409**

## Scanners

**MICROTEK**

Better Images Through Innovation.

ScanMaker E3	\$149.00
35T 35MM Slide	\$659.00
ScanMaker E6	\$279.00
ScanMaker III	\$1,199.00

Model not shown!

## ScanMaker V300

**\$129**

- 24-bit color depth
- Single-pass speed
- 300x600 dpi optical resolution

**Agfa**

SnapScan	\$269.00
StudioStar	\$699.00
Arcus II (PhotoLook)	\$1,299.00

**Umax**

Astra 600	\$179.00
Astra 1200 (soho)	\$299.00
Astra Transp. Adapter	\$179.00
PowerLook II	\$899.00
Power Look 2000	\$1,999.00

√ after manufacturer's rebate

## ArtPads

**4" X 5" art Z II**

**\$129**

**WACOM ArtPad II 4"X5"**

Art Z II 6"X8"	\$299.00
Art Z II 12"X12"	\$399.00
Art Z II 12"X18"	\$659.00
Art Z II 18"X25"	\$1,699.00
Ultra Pen	\$65.00
4-button puck	\$38.00

## Apple Message Pad 2000

• 160MHz RISC proc.  
• 16-level Hi-resol. screen  
• 2 PC Slots for memory and wireless modem or any other compatible card.

**\$899.**

\*Modem not included.

**CALL 1-800-404-9976**

Schools & Corp. P.O.s are Welcome Customer Service Toll-free number : 1-800-743-2998 McNet is not responsible for typos!  
ALL PRICES ARE CASH DISCOUNTED. Prices & product availability subject to change without notice - Any merchandise returned is subject to a restocking fee! When returning, call for a RMA# first! Thank You!





# ON THE MAC MARKET!

## Software

### Business

Microsoft Office 4.2.1  
Full version

**\$299.**

- Microsoft**
- Microsoft Office 4.2.1 (full version).....\$299.
  - Office 4.2.1 (upgrade).....\$199.
  - Microsoft Word 6.0.1 (full version).....\$269.
  - Microsoft Excel 5.0 (full version).....\$269.
  - Microsoft Excel 5.0 (upgrade).....\$119.
- Now Software**
- Now Contact and Up-to-Date 3.6.5.....\$79.
- Shana**
- Informed Designer 2.0 (form designer).....\$189.
  - Informed Filter (form filler).....\$129.
- Timeslips**
- Timeslips 4.0.....\$279.

### Design / Graphics

Adobe Photoshop 4.0  
Upgrade

**\$129.**



Adobe Photoshop 4.0

### Adobe Systems

- PageMaker 6.5 (full version).....\$389.
- PageMaker 6.5 (upgrade).....\$89.
- Photoshop 4.0 (full version).....\$389.
- Photoshop 4.0 (upgrade).....\$129.
- Illustrator 7.0 (full version).....\$299.
- Illustrator 7.0 (upgrade).....\$89.
- FrameMaker 5 (full version).....\$479.
- Streamline 4.0 (full version).....\$129.

- Artifice**
- Design Workshop 1.5.....\$569.
- Astound**
- Astound 3.0 (presentation w/ multimedia).....\$126.

- Deneba**
- Canvas 5.0 (design & illustration).....\$379.

- Engineered Software**
- Power CADD 3.0 (pro-level draft-prog.).....\$639.

- Fractal Design**
- Detailer (Paints 3D models).....\$289.
  - Expression 1.0 (object-oriented drawing).....\$289.
  - Painter 5.0 (full version).....\$259.
  - Painter 5.0 (upgrade).....\$89.
  - Poser2.0 (human-models in 3D enviro).....\$129.

- Graphsoft**
- MiniCad 7.0.....\$499.
  - BluePrint 5.....\$199.

## Painter 5.0



The World's Most Creative Design Tool!

**\$269.**

Radical New Features for Unlimited Creative Freedom!

**ImageXpress**

ScanPrepPro 3.1 (automates image-process).....\$639.

**IMSI**

Turbo CAD 2D/3D 3.0 (semi-pro CAD soft).....\$129.

**Macromedia**

Director 6 multimedia studio (full version).....\$899.

Director 6 multimedia studio (upgrade).....\$459.

Macromedia xRes 3.....\$299.

Director 6 (upgrade).....\$369.

Extreme 3D 2.0 (3D-design,print,animation).....\$349.

### FreeHand 7 - graphics studio

Upgrade

**\$169.**



Free Hand V7.0 (full version).....\$199.

Free Hand V7.0 (upgrade).....\$135.

SoundEdit 16.2 (full version).....\$269.

Macromedia Flash (full version).....\$189.

Fontographer (full version).....\$299.

## Quark Xpress 4.0



The Best price on the Market!

Only **\$699.**

Quark

QuarkXpress 3.3.2 (publishing).....\$619.

QuarkXpress 4.0 (publishing+Web).....\$699.

**Specular**

Infini-D 4.0(3D/Animation/modeler).....\$399.

Infini-D 4.0(upgrade).....\$419.

Collage 2.0 CD.....\$79.

**Others**

Eye Candy 3.0 (Photoshop filters).....\$189.

Object Dancer 1.1 (Object-oriented animat.).....\$419.

Phototools 1.1(Photoshop filters).....\$94.

Texture Creator 2.0 (Pro Level 3D graphics).....\$125.

Walkthrough 2.6 (Architectural design).....\$449.

## Internet / Database

\*Instant Database publishing on the Web/  
\*Desktop publishing with Database content/  
\*Launch Java applets and much more...  
Upgrade

**\$95.**

### FileMaker 4.0



Claris FileMaker Pro 4.0 (FullVersion).....\$189.

Claris Home Page.....\$94.

Claris Works Office.....\$94.

Claris E-Mailer 2.0 (e-mail manager).....\$39.

**Farallon Communications**

Timbuktu Pro 3.0.....\$125.

**Net Objects**

Net Objects fusion 2.0(Website builder).....\$449.

**RUN**

RunShare 2.1(AppleTalk network 2-users).....\$289.

**StarNine tech.**

Quarter Deck Mail 4.0 (Mail server).....\$299.

Quarter Deck Mail 4.0 (5-user pack).....\$199.

**Symantec**

Symantec Visual cafe.....\$194.

Symantec Visual Page.....\$94.

**Adobe Illustrator 7**

Upgrade from V.5.0 or later

• A Solid • reliable • complete • graphics • Application

Adobe Illustrator 7.0 • Application **\$89.**

**Utilities/Programming**

**Apple Computer**

MAC OS 8 (Macintosh operat. system).....\$95.

Share IP 5.0 (Network manager).....\$699.

**Caere**

Omni Page Pro 7 (OCR soft. pack).....\$439.

**Casady & Greene**

Conflict catcher 4.0.2 (Start-Up tool).....\$69.

**Connectix**

Speed doubler 2.0.1. (file transfer utility).....\$89.

RAM doubler 2.0.1. (Doubles your RAM).....\$89.

**Datawatch**

Virex 5.7 (great features in virus-detection).....\$67.

**Metroworks**

Code Warrior 1.0 gold(programming).....\$339.

**mfactory**

mTropolis 1.1 (authoring tool).....\$1099.

**Now soft.**

Now utilities 6.7.....\$85.

**Starnine tech**

ListStar 1.1 (mailing-list management).....\$429.

**Symantec**

SAM 4.5 (virus protection).....\$49.\*

## Effects/Plug-ins/Media

### Adobe After Effects 3.1



•Broadcast multimedia and Film production Tool!

Save \$200

**\$399.**

**Adobe**

Premiere 4.2 (full version).....\$399.

Persuasion 4.0 (full version).....\$299.

**Allegiant Tech**

SuperCard 3.0 (authoring tool w/ web plug-in).....\$299.

**Artel Software**

Boris Effects 2.1 MP (Adobe plug-in).....\$499.

**DigiEffects**

Aurorix 2.0 (full version).....\$249.

Berserk 1.3 (full version).....\$249.

Cyclonist 1.0 (particle-generation soft.).....\$429.

**Extensis**

OX-Tools 2.0 (Xtensions-collection).....\$94.

**Knoll soft.**

Lens Flare Pack 1.5 (after effects plug-in).....\$139.

**MetaTools**

Bryce 2.....\$168.

Final Effects AP 1.0 (particle-generation).....\$189.

KPT Final Effects 3.0.1 (effects collection).....\$659.

Studio Effects 1.0 (3D particle-generator).....\$659.

**M.M.M. Soft.**

HoloDozo 1.0 (Adobe Premiere plug-in).....\$129.

**NewTek**

LightWave 3D (Pro-Level animation).....\$1399.

**The Valis Group**

Movie Flow 2.0.2. (image distortion soft.).....\$639.

**XaosTools**

TypeCaster 2.0 (3D text-plug-in).....\$169.

Most widely used desktop web server software on the Internet!

**\$399**

**W/Free! Bundled Software**

**Others/Various**

Delta Graph 4.0.....\$135.

Dantz Retrospect 4.0 (net. back-up).....\$139.

Letter Rip 1.0.2 (Superb mail-list server).....\$269.

Live Picture XT.....\$138.

Prism 2.0 (ideal statistics package).....\$459.

QuickKeys 3.5.2 (Powerful Macro Utility).....\$115.

Roaster Release 3 (Java Tools).....\$95.

SoftWindows 95 v4.0.....\$299.

Ultimate for Mac 2.0 (Keying prog. tool).....\$199.

Wingz 2.1.1 (Powerful prog. tool).....\$369.

## STORAGE - MEDIA & HARD DRIVES

### JAZZ DRIVE



**\$389**

Jaz Drive w/ 1 cartridge.....\$389

Internal Jaz Drive.....\$219

1GB Jaz Cartridge.....\$82

**JAZ & CD-RECORDER DUO**

Jaz Drive & LaCie 2X/6X CD-R.....\$799

**SYJET & CD-RECORDER DUO**

SyJet 1.5G & LaCie 2X/6X CD-R.....\$799

### ZIP DRIVE



**\$129**

Zip drive w/ 1 cartridge.....\$129

Zip 100MB cart. (10-pack).....\$125

Internal Zip drive.....\$145

100MB Zip cartridge.....\$13

### CD/CD-R/Removables



**\$379**

Catch the CD-R Wave!

•For large file transfers, or mass distribution of media,(sound/image) CD-R provides the least expensive solution!

•Comes w/ Toast Pro software (a super value).

### Magneto-Opticals

230MB Olympus SYS 230.....\$329

640MB Fujitsu 640 Optical.....\$469

2.6GB Sony 2.6GB Optical.....\$1,499

**Syquest/Microtech/Maxwell**

SyJet 1.5GB drive.....\$369

SyJet 1.5GB cartridge.....\$95

200 Megabytes cartridge.....\$52

270 Megabytes cartridge.....\$45

**CD-ROM**

2X/6X CD-R w/Toast software.....\$389

4X/6X CD-R w/Toast software.....\$659

LaCie 12X CD-ROM (free LaCie FM Radio).....\$179

LaCie 24X CD-ROM.....\$199

## Capacity Model Access RPM Interface Drive cache Int. Ext.

Capacity	Model	Access	RPM	Interface	Drive cache	Int.	Ext.
2.1 GB	Quantum TM2110S	11 Ms	4500	Ultra SCSI-3	128k	\$229	\$279
	Seagate 32151N	9 Ms	5400	Ultra SCSI-3	256k	\$299	\$349
	Quantum ST2160S	10 Ms	5400	Ultra SCSI-3	128k	\$229	\$279
	Quantum Atlas 32275	8 Ms	7200	Ultra Wide SCSI-3	512k	\$289	\$339
	IBM 32160W	8.5 Ms	5400	Ultra Wide SCSI-3	512k	\$229	\$279
3.2 GB	Quantum M3240S	10 Ms	5400	Ultra SCSI-3	128k	\$309	\$359
4.3 GB	Conner CFP4207W	10 Ms	7200	Fast Wide SCSI-2	512k	\$499	\$549
	Fujitsu M2934SAU	8 Ms	7300	Fast SCSI-2	512k	\$559	\$599
	Fujitsu M2954SYU	8 Ms	7300	Ultra SCSI-3	512k	\$599	\$649
	IBM DCAS-34330	8.5 Ms	5400	Ultra SCSI-3	512k	\$399	\$449
	IBM DCAS-34330W	8.5 Ms	5400	Ultra Wide SCSI-3	512k	\$399	\$449
Quantum CY54353A	14 Ms	3600	EIDE-4	128k	\$259	\$319	
4.5 GB	Seagate ST34501W	8.5 Ms	10033	Ultra Wide SCSI-3	512k	\$699	\$749
	Micropolis MC4345WS	7.9 Ms	7200	Ultra Wide SCSI-3	512k	\$599	\$649
	Seagate ST34572W	8.9 Ms	7200	Ultra Wide SCSI-3	512k	\$699	\$749
	Quantum AL34550S	8 Ms	7200	Ultra SCSI-3	512k	\$549	\$599
	Quantum AL34550SW	8 Ms	7200	Ultra Wide SCSI-3	512k	\$599	\$649
6.5 GB	Quantum QTST6480s	10 Ms	5400	Ultra SCSI-3	128k	\$469	\$519
9.1 GB	Micropolis 3391NS	7.9 Ms	7200	Ultra SCSI-3	512k	\$949	\$999
	Quantum AL39100SW	8 Ms	7200	Ultra Wide SCSI-3	1024k	\$899	\$949
	Seagate 19171N	9 Ms	7200	Ultra SCSI-3	512k	\$990	\$1050



## "Custom Configuration Specialists"

•Dealers & International sales welcome!  
•Govt., University & Corporate P.O.'s Welcome.  
•Best Prices, Service & Delivery.

Web Site @ [www.infinity-micro.com](http://www.infinity-micro.com)



One stop shopping for all your software & hardware needs!

# 800 • 589 • 1234

### POWERMAC

4400/200 16/2GB/CD/KB	\$1095.
4400/200 32/2GB/CD/DF/KB	\$1285.
6100/60 8/250/CD	\$595.
6100/66 16/500/CD/DOS	\$995.
6500/225 32/3GB/CD/3F/KB	\$1495.
6500/250 32/4GB/CD/ZIP/KB	\$1795.
6500/250 48/4GB/CD/3F/MS	\$1845.
6500/275 48/4GB/AVID	\$2195.
6500/300 64/4GB/12XCD	\$2195.
7100/80 8/700/CD	\$895.*
7100/80 16/700/CD/AV	\$995.*
7200/90 8/500/4XCD	\$895.*
7200/120 16/16/4XCD	\$1095.
7200/120 8/1.2/ACD/PENT.	\$1695.
7300/180 16/2GB/CD/KB	\$1695.
7300/200 32/2GB/CD/KB	\$1895.
7600/100 16/16/4XCD	\$1295.
7600/132 16/1.2/8XCD	\$1495.
8100/100 16/16/1G/CD/AV	\$1385.
8100/110 16/2GB/CD	\$1395.
8500/132 16/16/4XCD	\$1595.
8500/150 16/1.2G/8XCD	\$1649.
8500/180 32/2GB/8XCD	\$1995.
8600/200 32/2GB/CD/zip/kb	\$2595.
8600/300 32/4gb/12xCD/z/k	\$3395.
9500/180MP 32/2G/8XCD	\$2495.
9500/200 32/2G/8XCD	\$2795.
9600/200 32/4GB/CD/KB	\$2895.
9600/200MP 32/4GB/CD/KB	\$3395.
9600/233 32/4GB/12XCD	\$2895.
9600/300 64/4GB/16xCD/zip	\$3895.
9600/350 64/4GB/24xCD/zip	\$3895.

### W.G. SERVER'S

7250/120 12/1GB/Internet	\$1395.
7350/180 48/4GB/12xCD	\$2375.
7350/180 48/4GB/CD/Internet	\$2795.
7350/180 48/4GB/CD/A.Share	\$3895.
9650/233 64/4GB/CD/Internet	\$4695.
9650/233 64/2x4GB/CD	\$5645.
9650/233 64/2x4GB/CD/A.S.	\$5645.
9650/233 64/4GB/AS/DAT	\$5645.
9650/350 64/4GB/CD/A.S.	\$5645.
500/132 32/CD/Base System	\$6295.
500/132 32/2GB/DAT/CD	\$7895.
700/150 32/1GB/CD	\$7495.
700/150 48/4GB/DAT/CD	\$9295.
700/200 48/2x4GB/CD	\$10695.

### NEWER TECHNOLOGY

MAXPOWER 200MHz	\$589.
MAXPOWER 225MHz	\$739.
MAXPOWER 360MHz	\$939.
MAXPOWER 400MHz	\$979.
MAXPOWER 450MHz	\$1079.
NUPOWER 1400 183MHz	\$579.
NUPOWER PB-500 183MHz	\$785.

### PERFORMA

5200/75 8/800/CD	\$895.
5215/75 8/16/CD/14.4	\$949.
5260/100 16/800/CD	\$1095.
5300/120 16/1GIG	\$1095.
5400/180 16/1.2/CD	\$1295.
6400DS 12/500/CD	\$695.
6116 8/500/CD	\$595.
6200/75 8/16/CD	\$595.
6220TV 16/1.2G/CD	\$745.
6300/100 16/1.2/CD	\$745.
6320CD 16/1G/CD	\$795.
6360/160 16/1.2/CD	\$895.-
6400/180 32/2G/CD	\$895.
6400/200 16/2.4/CD	\$1049
6400/200VE 16/2.4/CD	\$1689.

### POWERBOOK

3400C/240MHz 16/3GB/CD	\$4095.
3400C 200MHz 16/2GB/12xCD	\$3395.
3400C 200MHz 16/2GB/8xCD	\$3195.
3400C 200MHz 16/2CDno mdm	\$2995.
3400C/180MHz 16/1.3GB/12CD	\$2995.
3400C/180MHz 16/1.3GB/6xCD	\$2795.
1400C/166 16/2GB/8XCD	\$2445.
1400C/133 16/1GB/CD	\$2295.
1400C/117 32/1 GIG/CD	\$2095.
1400CS/117 16/750/6XCD	\$1695.
1400CS/133 16/2.1GB/CD	\$1895.
5300CE/117 32/1G	\$1795.
5300C 24/500	\$1495.
5300C 16/1GIG	\$1595.
5300CS 16/750	\$1295.
5300CS 16/750/Case	\$1095.
2300C 20/1GB/14.4/D00CK	\$1795.
2300C 20/1GB/14.4	\$1295.
2300C 8/750	\$995.
540C 16/500/14.4	\$1195.
5300 8/500 MONO for a Newer Model.	\$895.
520/150/190CS	\$3895.

### SUPERMAC / UMUX

Umax S900/2500P 64/4GB/CD/A.S.	\$6395.
Umax S900/2000P 32/2GB/CD	\$3095.
Umax S900/1800P 32/2GB/CD	\$2795.
Umax S900/250 32/2GB/CD	\$3495.
Umax S900/233 32/2GB/CD	\$2795.
Umax S900/200MHz 32/2.1 HD/6Pci/KB	\$2395.
Umax S900/180MHz 32/2.1HD/6Pci/KB	\$1795.
Umax J700 604e/180MHz 24/2GB/2MB	\$1445.
Umax C600 603e 200MHz 24/2.1/28.8	\$1295.
Umax C600 603e 200MHz 16/2.1/28.8	\$1295.
Umax C600E 200MHz 32/2GB/12x/2G	\$1645.
Umax C600 603e 180MHz 16/1.2/8xCD	\$1095.
Umax C500 603e 180MHz 16/1.2/8xCD	\$1095.
Umax C500 603e 140MHz 16/1.2/8xCD	\$945.

### DEMO POWERBOOKS

PB 180c Color	850
540C 12/320/Mod	1045
5300cs 16/500	1099
145 - 170 - 180c-165c	CALL
5300CS 8/500	999

TEL 310 • 470 • 9426

FAX 310 • 470 • 4956

"We Match, We Beat, We Deal." CALL US LAST!!!

### MONITORS

Apple 14" /15" Multiscan	\$249./\$299.
Apple 15"AV Multiscan	\$345.
Apple 17" Multiscan	\$595.
Apple 1705/1710	\$585./\$745.
Apple 1710AV Multiscan	\$795.
Apple Vision 750	\$795.
Apple Vision 750AV	\$895.
Apple Vision 850 20"	\$1445.
Apple Vision 850AV 20"	\$1795.
Apple 20" Multiscan	\$1095.
Magnavox 20" Color	\$895.
Radius PrecisionView 21"	\$1695.
Radius PressView 17SR	\$1595.
Radius PressView 21SR	\$2995.
RasterOps MC20 20".28	\$1245.
RasterOps MC-801 21"	\$1595.
RasterOps MC-801HR	\$1749.
RasterOps M7515 19"	\$1095.
SuperMac 21" Color	\$895.
Sony 100SX/100SF	\$335./\$379.
Sony 200SX/200SF	\$619./\$689.
Sony 17SE2	\$799.
Sony 300SF-20"	\$1329.
ViewSonic 17GA Multi	\$619.
ViewSonic 17EA-17"	\$589.
ViewSonic GT-770 17",.25	\$649.
ViewSonic GT-800 20"	\$1145.
ViewSonic PT-810 21",.25MM	\$1445.
ViewSonic P810 21",.25MM	\$1295.
ViewSonic P815 21",.25MM	\$1295.
ViewSonic G810 21",.25MM	\$1095.
ViewSonic PT-813 21",.28	\$1395.

### PRINTERS

StyleWriter II	\$179.
StyleWriter 1200/1500	\$99./129.
StyleWriter 2200	\$389.
StyleWriter 2400/2500	\$149./189.
StyleWriter 4100 Color	\$239.
StyleWriter 4500 Color	\$339.
StyleWriter 6500 Color	\$469.
LaserWriter 4/600	\$1289.
LaserWriter 12/640	\$1995.
LaserWriter 12/600	\$1689.
LaserWriter Color 12/660New	\$4995.
LaserWriter Color 12/660Demo	\$2995.
LaserWriter Color 12/660Demo	\$2495.
Epson Stylus 600	\$279.
Epson Stylus 800	\$419.
Epson Stylus Pro-XL	\$1295.
Epson Stylus 3000 Color	\$1669.
Fargo Pictura 310	\$2992.
Fargo Pictura 310Ethemet	\$3499.
Fargo PostScript option	\$295.
Gcc Elite XL-1212 Laser	\$1089.
Gcc Elite XL-608	\$2089.
Gcc Elite XL-616	\$2345.
Gcc Elite XL-808	\$2699.
Gcc Elite XL-1208	\$3895.
HP Deskjet 870CXI	\$389.
HP Deskjet 1600CM	\$1585.
HP LaserJet 5MP	\$595.
HP LaserJet 6MP	\$875.
HP LaserJet 4MV	\$CALL.
HP Laser 5M	\$CALL.
HP Laser 5SIMX	\$3395.

### MOTOROLA STARMAX

5000/225 32/2.5/CD/56K	\$1795.
5000/250 32/2.5/Zip/56K	\$2045.
5000/275 32/4.5/CD/Zip	\$2395.
5000/300 32/4.3/CD/Zip	\$2445.
5500/200 64/4.3/CD/Zip	\$2545.
6000/233 32/2GB/CD/10BT	\$3395.
6000/266 64/2GB/Zip/10BT	\$3995.

### SOFTWARE

Adobe Photoshop 3.05	\$345.
Adobe Illustrator 6.0	\$279.
Adobe PageMaker 6.5	\$279.
Adobe After Effects	\$1245.
Quark Express package	\$649.
Microsoft Office package	\$295.
Electric Image Broadcast	\$2295.
Lightwave 3D 5.0	\$1095.

### ZIP/JAZZ/KB'S

Omega Zip drive	\$149.
Omega Jazz 1GB drive	\$395.
EZ-QUEST Jazz 1GB w.1 cart.	\$329.
MacAlley Extended KB	\$49.
Apple Extended Keyboard II	\$99.

### MEMORY PRODUCTS

PowerMac 16MB Dimms	\$79.
PowerMac 32MB Dimms	\$109.
PowerMac 64MB Dimms	\$229.
PowerBook 16MB 3400	\$95.
PowerBook 32MB 3400	\$179.
PowerBook 64MB 3400	\$379.
PowerBook 128MB 3400	\$695.

### GE 3 YEAR ON-SITE WARRANTY

\$1201 To \$ 2000	\$135.95
\$2001 To \$ 4000	165.95
\$4001 To \$ 6000	189.95
\$6001 To \$ 8000	\$ 219.95
\$8001 To \$ 10000	\$ 249.95

### NUBUS, PCI & PC CARDS

Centris 610/660AV nubus adapter	\$19.
Apple Pentium 100MHz card	\$399.
Apple Pentium 166MHz card	\$895.
IMS Twin Turbo 8MB PCI	\$469.
ATI Xclaim-VR 4MB card	\$279.
Precision Color 24/1600	\$445.
Radius Thunder30-1600 6MB	\$649.
Radius Thunder Color/30-1600	\$1899.
Radius Thunder Power/30-1600	\$545.
Radius Thunder Power/30-1920	\$795.
Radius Thunder 3D Pci card	\$1845.
TrueVision Targa 1000 Pci	\$1649.
TrueVision Targa 2000 Pro Pci	\$2995.
TrueVision Targa 2000 Pro demo	\$2395.
Targa 2000N 24BIT NTSC	\$1495.

### SCANNERS

AGFA Transpascal option	\$379.
AGFA StudioScan II Color	\$795.
AGFA Arcus II w. transpascal	\$1495.
EPSON ES-1000C COLOR	\$585.
Epson Exp. 636 Executive	\$849.
Epson Exp. 636 Artist 600dpi	\$1285.
Epson Exp. 636 Professional	\$1695.
Microtec Scanmaker E3	\$345.
Microtec ScanMaker E6 STD	\$569.
Microtec ScanMaker E6 Pro	\$845.
Microtec ScanMaker III	\$1095.
Microtec ScanMaker 35T Plus	\$745.
Microtec ScanMaker Internet	\$565.
Umax Astra 600S 300dpi	\$179.
Umax Astra 1200S 600dpi, P.D.	\$375.
Umax Astra 1200S 600dpi, Psho	\$445.
Umax PowerLook II w. UTA	\$1249.

### Used powerbooks

160/180/540/230/280

all Available in stock please call.

**PowerBook**  
5300 8/500  
**\$899.**

**HP LASER 5MP**  
600DPI, POSTSCRIPT LVL2  
**\$599.**

**8MB MEMOERY**  
POWERBOOK 500 SERIES  
**\$29.**

**PowerBook**  
1400c 117MHz  
32MB/1GIG/6XCD/14.4  
**\$2199.**

"Over 2700 products to choose from!"

# TRADE YOUR MAC FOR A NEW ONE. We Pay Top \$\$\$ For Your Mac & Mem.

Competitive Leasing Email: [cgn@cgnusa.com](mailto:cgn@cgnusa.com) **BUY-SELL-TRADE** We custom configure and test your system.

### PowerMacs

9600 350 MHz	3199
9600 300 MHz	2985
8600 300 32-4Gb-CD	2490
8600 200 32-4Gb-CD	1999
8500 132 MHz	1590
7300 180 MHz	1745
6500	1499

Call For 350 & 300 Mhz

4400 200MHz	1095
7200 /75/90/120	CALL
Call for config. not listed	

### Powerbooks

3400C 240 Mhz	3735
3400C 200 Mhz	3290
3400C 180 Mhz	2650
1400C 16-1Gb-CD	2190
2400cs 12/750	1845

Call for New PB 3400

PB 180c Color	850
540C 12/320/Mod	1045
5300cs 16/500	1099
145 - 170 - 180c-165c	CALL
5300CS 8/500	999

### Upgrades

Same day Upgrade No down Time!	
Prf 63X to 6300 603-100MHz	490
7200 to 7600	675
8100 to 8500	850
7500 to 604-150/233	299/379
CALL for PowerBook Upgde	
Q800- Q840 to 8500	999
7100 to 7500/ 100	599
PB 520 / 540 to 5300	550
Q800-840 to 8100	490
PB 5300 to 3400/CD Call	
Call forUpgrades not listed	

### Demo Macs

8500 132/120 1299/1590	
7500/7600 990/1225	
9500	1450
8100/110 16/2GB/CD	1190
Q 800/ 840/950	450/550
7100/80	650
15" / 17" Monitor	240 / 460
Mac IICI	149

### Performa

6200- 16/1Gb CD	590
Call for latest prices.	
6320/6400/4400/5212/575	

### Memory

Dimms 16/32/64	55 /99/190
30 Pin 1/4/16	8 / 23 / 75
72 Pin 8/16/32	32 /55 /99
2X - 4X-8x CD	50 /85/155
HD 1.GB - 2.GB-4GB	Call
lomega Jazz Drive	299
Global Village Modem	139

### Call For:

Monitors, Printers



# The Lowest Finance Rate Available

## FREE Software SuperBundle - \$3500 Value

Software SuperBundle - Adobe Premiere, Illustrator, PageMaker, Photoshop, LivePicture, Omni page Professional, DOS Mounter 95 Free with this Ultimate Graphics Workstation.

FULL-LINE AUTHORIZED SERVICE CENTER - MAC & PC EQUIPMENT REPAIR, DATA RECOVERY, SHORT-TERM RENTAL, LOANER PROGRAM AND POWERPC PROCESSOR 120/132/150/180/225/233/250/300/350 MHZ 233MHZ UPGRADE AVAILABLE AS LOW AS \$589.

**SUPERBUNDLE!**  
**\$399**  
**PER MONTH**



Power Macintosh 9600/350 Ultimate Graphics Workstation

- \$1589** PowerPC 9600/350MHZ or PowerTower Pro 250MHZ MP
- \$489** Internal 24x CD-ROM
- \$1389** 416 MB RAM
- 18GB internal RAID Disk
- Extended keyboard
- \$1589** Radius PrecisionColor 21" Color - 1600x1200 0.25mm Color monitor
- \$489** Twin-Turbo - 128bit Graphic Engine, 1600x1200, w/8MB Graphic Engine
- \$1389** Agfa Arcus II w/ Trans, 36-bit Scanner

- \$899** External combo drive combo w/Jaz drive, ZIP, SQ200MB w/Cart.
- \$649** Apple LaserWriter 600dpi PostScript printer 4/600 w/one cartridge and Cables
- \$149** Active SCSI terminator, One 25/50 SCSI cable, five 50/50 cables
- \$199** UPS Battery Back-Up
- Apple QuickDraw 3D PCI Accelerator Card - 12 X Faster
- Image Solutions Extended Services

**Adobe Specials - PageMill 2 - \$89 (MAC & Win.)**

Adobe Photoshop 4.0/Retail	\$299/\$369
Adobe Photoshop 3.0.5/LE	\$199/\$99
Adobe Illustrator 5.5/7.0	\$199/\$289
Adobe PageMaker V6.0/V6.5	\$199/\$289
Adobe Premiere 1.0.1/4.2	\$99/\$399
AfterEffects/Product. Bndle	\$499/\$1689
Persuasion V4/Dimension3	\$229/\$125
Acrobat V3.0/Type-on-Call	\$149/\$39
FrameMakerV5/Streamline4	\$469/\$125
Adobe PhotoDeluxe/ATM	\$35/\$59

**PowerBook - 1400 CS/117 12/750 \$1379**

PowerBook - 1400C /133 16/1GB/CD	\$2279
PowerBook-3400C/240 16/3GB/CD/M/E/F \$4579	

**System Bundle w/20" monitor, XKeyboard, Mouse**

	Buy!	Lease!
PowTowerPro/225 32/2.2GB/CD	\$3179	\$75
PM9600/300 64/4GB/12XCD	\$4599	\$109
PM9600/350 64/4GB/CD/ZIP	\$5499	\$139
PM9500/MP 180 32/2GB/8XCD	\$3999	\$87
PM8600/300 64/4GB/CD/ZIP	\$3749	\$79
PM7300/180 16/2GB/12XCD	\$2999	\$65
PM4400/200 16/1.2GB/8XCD	\$2499	\$55
StarMax 5000/300 32/4.3GB/CD	\$3349	\$79
SuperMac S900 /32/2.1GB/CD	\$3579	\$85
SuperMac C600 /16/1.2GB/CD	\$1989	\$55
DayStar MP400/ 2x200MHZ /32/2.2GB/CD (upgradable to 4x200MHZ)	\$5999	\$159

**Printer-STY1200\$99**

EpsonStylus3000	\$1659
Apple Laser 4/600	\$649
HP 4Mv 11x17	\$2389
GCC XL1208, 11x17	\$3869
Apple12/600 Color	\$3589*

**Monitor & Display Card**

DSC 15"/17" Color	\$269/\$395
DSC 20"/21" Color	\$889/\$1239
ViewSonic 17"/19"	\$599/\$949
Radius17"/21" Color	\$639/\$1589
IMS 4MB/8MB 3D	\$285/\$445

**Microsoft - Office V4.2.1 - \$149**

Microsoft Office 4.2.1 /97	\$149/\$249/\$279
Microsoft Word 5/6.0.1	\$149/\$199
Microsoft Excell 4/5.0	\$149/\$199
M.S. Project v4/FrontPage	\$249/\$99
PowerPoint 4/Works 4	\$199/\$99
MiniCAD7/BluePrint5	\$489/\$199
WordPerfect 3.5/M.Y.O.B.7	\$79/\$69

**SyQuest**

270MB	\$54
200MB	\$61/\$54
EZ 135	\$19/\$22
88MB	\$41/35
44MB	\$37/32

**Jaz**

1.0GB Jaz	\$79
100MB Zip	\$11*

**lomega**

1.0GB Jaz	\$79
100MB Zip	\$11*

**Optical**

74Min CD	\$2.49
DSC 128MB	\$7.49
DSC 230MB	\$9.79
DSC 650MB	\$28.99
DSC 1.2GB	\$37.99

**Memory**

	30 pin	72 pin	168 pin
4MB	\$25	\$25	-
8MB	\$37	\$37	\$37
16MB	\$69	\$69	\$69
32MB	-	\$124	\$124
64MB	-	-	\$239

**Ext. H/D, DAT Tape, MO, SyQ & CDR Devices**  
(Minus \$39 for Internal Drive)

42MB/160MB/230MB/540MB	\$89/\$129/\$149/\$199	Turbo \$25
1GB/2GB/3.2GB/4.3GB	\$239/\$275/\$365/\$405	\$25
4.5GB/6.4GB/9.1GB	\$669/\$535/\$1125	\$25
7200rpm 4.5GB IBM/Quantum/Seagate	\$719/\$739/\$819	\$29
Micropolis/Quantum/Fuji 9.0GB 7200rpm	\$1125	\$49
SONY DAT Seagate 5000/7000	\$899/\$949/\$1149	\$89
DLT Tape Drive 30GB/40GB	\$2749/\$3579	\$99
ExtraByte 5GB Tape Dr.	\$1199	\$1249
SyQuest 270/200MB Ext. Drive	\$299/\$339	\$25
SyQuest EZ135/EZ230	\$109/\$145	\$25
Panasonic 650MB M.O. Dr.	\$699	\$749
SONY 1.3GB M.O. Drive	\$989	\$1099
Pinnacle Micro 4.6GB M.O.	\$1189	\$99
Olympus 230MB/2.6GB M.O. Drives	\$309/\$1649	\$99
Fujitsu 230/640 MB M.O. Drive	\$469/\$599	\$49
Philips/Rioch Rewritable CDR 6X/2X	\$589/\$629	\$49
SONY CDR 6X/2X w/Toast	\$399	\$429
Yamaha CDR 6X/4X w/Toast	\$689	\$729
Ext. Jaz/Zip & DiskArrays	Ext.	Turbo
10 Mega Zip ext. Dr. w/Cart.	\$135	\$155
Jaz ext. Dr. w/ Cart.	\$375	\$25
Jaz + CDR ext. Dr w/SW	\$779	\$989
SyJet 1.5GB Dr. w/2X cart.	\$395	\$429
4GB DiskArray	\$749	\$799
8GB F&W DiskArray	\$1289	\$1389
16GB F&W DiskArray	\$2449	\$2599
24GB F&W DiskArray	\$3549	\$3699

**Scanner: UMAX Mirage 11x17 - \$3489**

Epson 1000C/636	\$489/\$735	Sale
LinoColor JADE/SAPHIR	\$469/\$1789	
Microtek V300/E3/E6	\$145/\$185/\$289	
UMAX Astra 600 /1200	\$165/\$295*	Sale
UMAX PowerLook II/2000	\$1239/\$2589*	
Agfa StudioStar / Arcus II	\$729/\$1329	Sale
Nikon CoolScan / Super	\$895/\$1619	

**Jaz w/ Cart. \$295**

**\$99!**

**\$199!**

**\$1189!**

**\$149!**

**\$69!**

**\$29!**

**\$369!**

**\$589!**

**\$2.49!**

# 800-352-3420

Fax: 310-782-5974  
Email: imagesol@earthlink.net  
http://www.imagesolution.com  
385 Van Ness Ave. #110 • Torrance, CA 90501



Order from 6 to 9 weekdays, weekends from 9 to 9. Visit our showroom 9 to 6 weekdays, weekends by appointment.

Prices subject to change without notice. Not responsible for typographical errors. 24 hour replacement limited to products in stock.

**Image Solutions**

The solution provider for print shops, service bureaus and imaging professionals



Buy 150 Blank CDs  
@\$2.49 and receive  
a Free 12X CD Drive!!

★ **Holiday Super Special** ★  
Blank Media for only \$2.19 ea. with purchase of a CD-R!!

**CD Recorders**

- 2x2x6 Rewritable ..... \$529
- 4x6 Yamaha ..... \$499
- 4x8 Panasonic ..... \$489

Add \$60 for external  
All CD-Rs Include Free Toast

**CD-R Duos**

- JAZ2CDR (4x8) ..... \$879
  - CD2CDR(12x/4x8) ..... \$799
  - DAT2CDR(2 Gig/4x8) \$995
  - 2-UP CDR (4x8/4x8) ... \$999
- All Duo prices external

**Multi CD Copiers**

Call for price & config.

**Media** (CDs minimum 10)

- Media One ..... \$2.49
- Name Brand ..... \$3.49
- CD-RW ..... \$19.99
- Jaz Cartridges ..... \$89.95

**Software**

- Copy Cat(multi CD) ..... \$199
- Toast ..... \$79
- Gear ..... \$59

**Holiday special!**  
Includes:  
External Drive  
Toast Software  
Cables  
10 Pc. Media

**\$559**  
Complete Kit!



Yamaha 4X6!

**Jaz 2 CD**

**\$879**



**Holiday special!**  
Includes:  
External Drive  
Toast Software  
Cables  
10 Pc. Media

**\$539**  
Complete Kit!



Panasonic 4X8!

**CD 2 CDR**

**\$799**



Check Out Our WEB Catalog At [www.copycatshop.com](http://www.copycatshop.com)



**CD Copiers**  
We'll build the size you need.  
Call for prices and configurations.



**2 in 1 Printer!**  
Print on CDs or use as a desktop inkjet!

**\$979**



**Paragon Pro 1200**  
The Best Scanner at the Lowest Price!

**\$649**



Order Toll Free **1-888-663-3121**  
Open Mon-Sat 7 am -7 pm 760.510.9880 Voice 760.510.9888 Fax

**Copy Cat Shop**  
A DIVISION OF **Media One**

CIRCLE 431 ON READER SERVICE CARD

**Apple StyleWriter 1200**

- 360x360 dpi Ink-Jet
- Black & White
- 90 day warranty
- Refurbished
- Includes Printer cable and Ink

**ONLY \$89**



**Apple 13" & 14" Monitors**

- 13" RGB - \$179
- 14" Multiscan refurb - \$149
- 14" Color RGB - \$229
- Trinitron tubes
- Used
- 90-day warranty

**FROM \$179**



**Apple CD-ROM Bundles**

- CD12001** 8x CD-ROM \$99  
add Atlantic Tech speakers **only \$49**
- CD18001** 12x CD-ROM \$149  
add Atlantic Tech speakers **only \$29**
- CD36001** 24x CD-ROM \$199  
add Atlantic Tech speakers **only \$29**

- M105/M110 System
- Subwoofer/Satellite
- Ranked by CNET
- Add stands for \$9

**FROM \$99**



**Apple PowerMac 6100 DOS Card Kit**

- DOS Included
- All manuals/cables included
- Retail Box
- Full Warranty
- Fits 6115/6116 also
- Brand New in box

**ONLY \$99**



**Newton 120 2MB, OS 2.0**

- 2MB Internal RAM
- Newest OS
- 1 PCMCIA Slot

**FREE!**  
Get a Free Copy of Solitaire with any Newton order!

**ONLY \$149**



**MacWorks 800-482-2705**  
"Low Prices, Great Service... And A Monkey!"  
Voice 913-599-6227 • Fax 913-599-6111

USED		PARTS & ACCESSORIES	
PowerMac 9600/233 - 0/0/CD	\$2299	Apple Extended Keyboard - used	\$49
PowerMac 7600/120 - 16/1.2GB/4xCD	\$999	Apple Desktop Bus Mouse - new	\$49
PowerMac 6100/60 - 16/250/CD	\$599	Performa 630-640 Upgrade	\$99
Quadra 610 - 12/230/CD	\$399	GV 19.2 Internal Modem for 500 series PB	\$99
Performa 640 DOS - 12/500/CD	\$529	Painttalk Microphone	\$9
PowerBook 170 - 8/80	\$399	Manual/Auto Inject Floppy	\$79/\$99
PowerBook Duo 280c - 12/320/Modem	\$649	Apple MPEG Card for 630/6200/6300/6200 \$49	
PowerBook Duo 230 - 12/120	\$399	PB 190 Infrared Card Upgrade	\$29
Duo Dock - Original/Upgraded	\$199/\$249	PB 190/5300 8MB Ram Module	\$69
Macintosh 13" RGB Monitor	\$179	PB 500 8MB/Duo 6MB Ram Module	\$39
LaserWriter IIint - 300 dpi	\$199	IIcx/650/7100 Power Supply	\$89
LaserWriter IIintx - 300 dpi	\$249	Duo Dock Power Supply	\$119
LaserWriter III/IIg - 300 dpi	\$499/\$599	800/840/8100 Power Supply	\$129
Nubus Video Card - 8 bit	\$99	Focus L-TV Pro Mac RGB to TV Converter	\$99

**Mac IIsi, IIcx, IIci Bundles**

- II 4/40/Video \$199
- IIx 4/40/Video \$229
- IIcx 4/80 \$279
- IIsi 5/80 \$299
- IIci 4/80 \$349

**FROM \$199**



**PowerMac 8600/300**  
32/4GB/24xCD/Zip/Keyboard

- 300 Mhz 604e
- 100Mhz Bus
- 1MB Cache
- 2MB VRAM
- 32MB RAM
- 4GB AV HD

**FROM \$2999**



**APPLE 604/132 UPGRADE CARD**  
for PowerMac 7500, 7600, 8500 and 9500

**ONLY \$49**



SEE OUR WEB PAGE FOR FULL LINE OF PRODUCTS e-mail: [sales@macworks.com](mailto:sales@macworks.com) • web: <http://www.macworks.com/> • Prices Subject to Change • All Prices Represent 2% Cash Discount • We only ship FedEx • \*Denotes Refurbished or Used

CIRCLE 430 ON READER SERVICE CARD



## Epson ES 300/GS Personal Document Scanner

- Sheetfed image and text scanner
- 4 ppm scanning speed
- 10-sheet feeder built in
- SCSI interface
- 8-bit grayscale, 300-dpi
- OCR software included



**\$49**

## Color LaserWriter 12/600PS

- supports Mac, DOS, UNIX, even Windows
- true 600x600-dpi
- Color PhotoGrade
- prints up to 12-ppm
- Enhanced Grayscale
- LocalTalk, Ethernet, and Parallel ports



REFURBISHED **\$2299**  
\*Color LaserWriter 12/660 only \$2499

## Performa 6300/100 FREE software!

- 100-MHz PowerPC™ 603e
- internal 14.4 faxmodem
- 14" Apple Display
- keyboard & mouse



16/1.2GB/4XCD  
**Complete!**

**\$1049**

## Performa 5200/75

- 8/800/4XCD
- 75-MHz PowerPC™ 603
- built-in display
- mouse & keyboard



**\$899!**

factory refurbished

**Complete!**

## NEW APPLE BX INTERNAL CD-ROMS

UPGRADE YOUR OLD 2X OR 4X CD-ROM DRIVE FOR

**Only \$99!!**

\*mounting kit not included

## PowerPort Mercury

GlobalFax software included. Features data transfer speeds of 19.2Kbps and fax speeds of 14.4Kbps. Fastest standard modem available for the PowerBook 520 series



BRAND NEW! **\$149**

## Personal NT to NTR Upgrade

Turn your Personal NT printer into a Personal NTR with a simple logic board upgrade. The NTR features PostScript Level 2 and a fast RISC processor!



NEW W/EXCHANGE **\$79**

## PowerComputing

### PowerCenter Pro 180 Minitower

- 180-MHz PowerPC 604e
- 32MB of RAM, 2GB hard drive
- 16X CD-ROM
- 2MB VRAM
- keyboard & mouse
- factory refurbished



**\$1799**

PowerPC™

Low-profile with 16/2GB/16XCD Only \$1599!

### PowerBase 240 Minitower

- 240-MHz PowerPC 603e
- 16MB of RAM, 1.2GB hard drive
- 8X CD-ROM
- keyboard & mouse
- factory refurbished



**\$1199**

PowerPC™

### PowerCenter Pro 210LP

- 210-MHz PowerPC 604e
- 16MB of RAM, 2GB hard drive
- 16X CD-ROM
- 2MB VRAM
- keyboard & mouse
- factory refurbished



**\$1699**

PowerPC™



### PowerBook 150

- Refurbished
- 33-MHz 030 processor
- 8MB RAM, 120MB HD
- passive-matrix grayscale

**\$699**

### PowerBook 540c

- Refurbished
- 33-MHz LC040 processor
- 12MB RAM, 320MB HD
- Built-in Ethernet
- Active-matrix color

**\$1099**

Add a 19.2 Mercury Modem to the 540c for only \$99!!



### PowerBook 5300c

- Factory Refurbished
- 100-MHz PowerPC 603e
- 8MB RAM, 750MB HD
- Dual-scan color display

**\$1049**

## StyleWriter 1200

- high-quality graphics/text
- 100-sheet capacity
- 720-dpi resolution
- One-year factory warranty



NEW **\$149**

## QuickTake 200

Store high-quality 24-bit images on a removable 2MB data card. 640x480 resolution. LCD display.



RECONDITIONED **\$599**

## QuickTake 150

Capture 32 standard-quality images or 16 high-quality images. Includes closeup lens.



RECONDITIONED **\$329**

## APPLE 11X17 COLOR INKJET

Great for large-format color printing. The M9500 Apple Color Inkjet printer features 360-dpi print resolution, four large CMYK ink tanks, SCSI and parallel ports for MacOS or Windows support.



BRAND NEW **\$399**

## E-Machines DoubleColor SX

- 8-bit accelerated video
- hardware pan & zoom
- for nubus-based Macs
- virtual screens feature



BRAND NEW **\$99**

## DuoDock BLOWOUT!

Get an Original Apple DuoDock for your Duo 210 or 230. Upgradable on-board video for large displays. \*DuoDock Plus pictured



RECONDITIONED **\$299**

## POWERBOOK 5300C

100-MHz PowerPC 603e • 8MB of RAM/500MB HD supports external video • ACTIVE-MATRIX COLOR

**\$1499**



## MACINTOSH LOGIC BOARD UPGRADES

PowerMac 8100 to 8500/120 (exchange)	\$999
Quadra 950 to WGS 9150 (exchange)	\$999
PowerMac 7200 to 7500/120 (exchange)	\$699
Performa 630 to 6200/75 (exchange)	\$399
Performa 630 to 6300/100 (exchange)	\$499
Performa 6200 to 6300/100 (exchange)	\$249
Quadra 800 to PowerMac 8100/80 (exchange)	\$599
Quadra 660 to PowerMac 6100/60 (exchange)	\$449
Performa 600/11vx to Centris 650 (exchange)	\$279

### POWERMAC 7200/75 LOGIC BOARD

**\$149**

BRAND NEW!  
(build your own Mac!)



### Internal 14.4 faxmodem

For the Performa™ series. Enjoy online services and send/receive faxes!  
**ONLY \$29**  
90-day warranty



### 800, 840, 8100 POWER SUPPLIES

Original factory part from Apple. Brand new.



NEW **\$199**

### APPLE ADB MOUSE II

The original Apple ADB Mouse II. In stock!



**ONLY \$49**

### LC Power Supplies

Original Factory Part!  
**Only \$39**



REFURBISHED

### 6100 Power Supplies

Original Factory Part!  
**Only \$199**



### ORIGINAL APPLE 1.44 FLOPPY

We have original Macintosh floppy drives!



**Now \$99 and up**

## Macintosh CPUs

*Performa 635 4/250	\$499
**Performa 5200 8/800/4XCD	\$899
*Centris 650 4/0 (LC040 processor)	\$499
*Quadra 660w 4/0	\$549
*Quadra 840w 0/0	\$749
*Quadra 800 8/0	\$749
**PowerMac 8500/120 16/1GB/4XCD	\$1599
*WGS 95 16/700/CD	\$999
*WGS 8150/80 8/500	\$1499
*WGS 9150/120 16/1GB/CD	\$1799

## Logic Boards on Sale

*Performa 600	\$129
*Performa 630	\$299
*Performa 6200	\$399
*LC	\$99
*LC II	\$129
*Mac IIcx	\$129
*Quadra 800	\$399
*Quadra 840w	\$449
*Quadra 950	\$449

## More Logic Board Upgrades

*LaserWriter IIsv/r1x to IIc	exch. \$399 sv/299 r1x
*Mac II or IIx to IIcx	exch. \$249
IIc to Centris 650	exch. \$299

## NuBus Adapters & Misc.

Quadra 660w NuBus Adapter	\$49
Quadra 610 NuBus Adapter	\$49
*Quadra 610 DOS Compatibility Card	\$99

Apple Color OneScanner	\$199
Apple Color OneScanner 600/27	\$349
UMAX UCS40 Scanner NEW	\$299
Epson ES-600C Scanner	\$349

## Video Cards

E-Machines DoubleColor SX 8-bit NEW	\$99
RasterOps 24MX NEW	\$199
Radius PrecisionColor 8/1600 PCI NEW	\$349
Micron XCEED for Performa	\$299
**6100 series AV Card with adapter	\$349
*PowerMac HPV VRAM Card (1MB VRAM)	\$179
**Apple QuickDraw 3D Accelerator Card PCI	\$199

## Monitors

Apple 14" A/V NEW	\$349
*Apple MultiScan 17"	\$499
**Radius IntelliColor Display/20c NICE!	\$1299
**Hewlett-Packard 17"	\$449
**Hewlett-Packard 20"	\$649

## Printers

**Apple StyleWriter 1200	\$139
*Apple LaserWriter 16/600PS	\$1199
**Apple Personal LaserWriter 300	\$329
*Apple Personal LaserWriter NTR	\$549
*LaserWriter III w/5MB RAM	\$749
*LaserWriter IIg w/5MB RAM	\$899

Laser toner cartridges sold separately  
\* indicates refurbished  
\*\* indicates factory refurbished

## WE STOCK MAC PARTS!

**1-800-227-3971**

• For your protection all credit cards accounts are strictly verified •  
FAX (318) 424.9771 • TECHNICAL SUPPORT (318) 424.7987  
CUSTOMER SERVICE (318) 424.9791 • PURCHASING/INFORMATION (318) 424.9791  
1200 MARSHALL STREET • SHREVEPORT, LOUISIANA 71101

Products are refurbished unless indicated as "new". Prices reflect a 2% cash discount and are subject to change without notice. Returns are subject to a 15% restocking fee. Not responsible for typographical errors. Refurbished systems may include like-new components and may also include cosmetic blemishes which do not functionally impair performance of the hardware.



# FANTASTIC DEALS ON ALL POWER PC's!

## Umax SuperMac C500

- POWERFUL 603e PROCESSOR!
- 200 MHz Processor
- 16mb RAM
- Multimedia CD-ROM Drive
- 2.0gb Hard Drive
- Fast PCI Expansion Slots

**\$899\***



## PowerMac System 20" Trinitron & 24 bit Accelerated Color

Complete Package!!

only **\$1699**

IMMEDIATE DELIVERY!!!



## PowerMac 8500

- POWERFUL 604 PROCESSOR!
- Up to 450 MHz Available
- 256 Level-2 Cache
- Multimedia CD-ROM Drive
- Video Capture In and Out
- 3 Fast PCI Expansion Slots

**\$1599\***



## Motorola StarMax Series

- POWERFUL PROCESSING
- 16mb RAM
- 512 Level-2 Cache
- Multimedia CD-ROM Drive
- 1.2gb Hard Drive
- 3 Fast PCI Expansion Slots

from **\$799\***



## Radius 81/110

- FASTEST NUBUS MACHINE!
- PowerMac NUBUS
- 16 MB RAM
- 256 Level-2 Cache
- Multimedia CD-ROM Drive
- 2.0gb Hard Drive with NUBUS card purchase

**\$999\***



## PowerMac 7500

- POWERFUL 604 PROCESSOR!
- Up to 450 MHz
- 256 Level-2 Cache
- Multimedia CD-ROM Drive
- 3 Fast PCI Expansion Slots

**\$1399\***



Macintosh IIfx  
With 15" Monitor

only **\$299**

GREAT NUBUS SOLUTIONS!

\*With Qualifying Monitor Purchase. All Units Factory Recertified, Up to 4 Year Warranties Available

## MONITORS

### 20" COLOR MONITORS

19" Viewable Trinitron Technology **\$599!!**

Radius SuperMatch 20 Plus **\$849**

Multi-Scan 20" Trinitron **\$999**

20" Multi-Resolution **\$1099**

Radius PrecisionColor 20v **\$1299**

Radius Intellicolor 20 **\$1299**



### 21" COLOR MONITORS

21" DiamondTron Monitor **\$1299!!**

RasterOps/Hitachi Superscan MC21 **\$1599**

Ikegami 21" Diamondtron **\$1399**

Radius Multiview 21 **\$1299**

Radius PrecisionView 21 **\$1599**

Radius 21" PressViews **from \$1499**

SuperMac 21" Color Display **\$1099**

### 17 INCH COLOR MONITOR

SuperMac 17 Multi-Scan **\$499**

E-machines T16 II Trinitron (16" Viewable) **\$529**

Radius PrecisionView 17 **\$599**

Radius PrecisionColor 17 **\$699**

Radius PressView 17sr **\$1599**

Portrait Display Labs 1700 **\$859**



### 15 INCH MONITORS

PrecisionColor Pivot **\$399**

Radius 15" Pivot (Grayscale & Color Options) **from \$199**

TWO PAGE GRAYSCALE MONITOR **from \$499**

Radius Full Page Display **\$299**

NEC, Sony, Mitsubishi, Viewsonic, Apple Monitors Also Available!!  
Need cards to drive your Monochrome/Grayscale Monitors?

## CLEARANCE

Emachine video card (24bit 832x624) **\$85**

Emachine video card (24bit 1024x768) **\$99**

Spectrum 24 PDQ (24bit 1152x870) **\$119**

Supermac Thunder 8 Accel. (8bit 1152x870) **\$75**

Thunderstorm for Photoshop Acceleration **\$75**

Atto Silicon Express 4 SCSI Accelerator **\$199**

Video Spigot IIsi and LC (video capture) **\$89**

Superview/Powerview (2pg's on Pwrbk & SE) **\$80**

Radius Rockets Accel. for Mac II Series **\$159**

SuperMatch 20" monitor w/Nubus card **\$899**

Color Calibrator **\$99**

ALL SALES FINAL ON CLEARANCE ITEMS!!!!

## GRAPHICS CARDS

### PCI VIDEO CARDS

IMS Twin Turbo 128 **\$199**

Radius PrecisionColor 8/1600 **\$399**

ATI XClaim VR 2mb **\$219**

Radius Thunder 3D **\$1699**

Radius ThunderTX 1152 **\$999**

Radius Tempest SRP **\$399**



### NUBUS VIDEO CARDS

1600x1200 (21" or greater resolution) **from \$499**

Thunder IIGX and Thunder IVGX series **from \$299**

1152x870 (21" resolutions) **from \$199**

PrecisionColor 24x, Spectrum Power 1152, Prism GT **from \$99**

1024x768 (20" resolutions) **from \$99**

PrecisionColor 24xk, Spectrum 24, Paintboard Lightning **from \$99**

832x624 (17" resolutions) **from \$99**

PrecisionColor 24xp, Futura Series **\$199**

Se/30, LC, or PDS bus?? Call Us!! **\$99**

Photoshop Accelerators **\$99**

Color Calibrators **\$99**

THOUSANDS OF CARDS IN STOCK!!! Call for prices on models not listed.

## DIGITAL VIDEO

### VIDEOVISION STUDIO

VideoVision Telecast **\$999!**

VideoVision Studio Array **\$1599**

VideoVision Studio Array **\$999**

• 4gb Array with SCSI Accelerator

Full Motion Digital Video Workstation **\$2799!**

Media 100QX and 100QX Component **\$CALL**

VideoVision PCI **\$CALL**

Video Spigot Cards **from \$99**

• Spigot II Tape, Spigot Nubus, LC and IIsi

Video Spigot Power and Pro AV **from \$399**

• FULL MOTION, full screen capture and playback

Video Vision Basic **from \$599**

MiroMotion, Bravado products available. Call for pricing.

## PROCESSOR CARDS

Apple 100 MHz 601 card **\$49**

Apple 120 MHz 604 card **\$99**

Apple 150 MHz 604 card **\$199**

MAXpower Processor Upgrades **\$CALL**

CLEARANCE!

## COMPUTERS

### AWESOME POWER!

#### Power PC 750

only **\$2999\***

- 250MHz & 266MHz Processors Available
- 512K & 1mb Backside cache available
- 32 mb RAM
- 2.0gb AV Hard Drive
- Multimedia CD ROM

#### Power PC 604e 400MHz

only **\$2499\***

- 400MHz & 450MHz Processors Available
- 512K & 1mb Backside cache available
- 32 mb RAM
- 2.0gb AV Hard Drive
- Multimedia CD ROM

### APPLE COMPUTER

Macintosh IIfx w/19" Trinitron & 24 bit card **\$999**

PowerMac 6400/180 16mb/1.2gb/cd **\$999\***

PowerMac 8100 16mb/2.0gb **\$899\***

PowerMac 8500 16mb/2gb/cd **\$1599\***

PowerMac 7300/180 16mb/2gb/cd **\$1799\***

PowerMac 8600/300 32mb/2.0gb/cd **\$2699\***

PowerMac 9600/300 64mb/4.0gb/cd **\$3299\***



### UMAX COMPUTER CORPORATION

SuperMac C500/180 **\$799\***

SuperMac C600/180 **\$999\***

SuperMac J700/180 **\$1649\***

SuperMac S900/200 **\$2309\***

### MOTOROLA COMPUTER GROUP

StarMax 3000/160 **\$799\***

StarMax 4000/200 **\$1199\***

### POWER COMPUTING

Call for latest availability!

Call for prices on models not listed!

\* with purchase of qualifying in stock monitor

## PRINTERS

### Apple LaserWriters

from **\$199**

- Laserwriter, IINT, Select 360, Pro 630 plus many more!!

### QMS 860 Hammerhead

**\$1799**

- 600 dpi 11 x 17 Tabloid Canon Engine
- Same Technology as HP4mv

### QMS 825 8ppm Canon Engine, Postscript IBM/Mac

**\$399**

### Star SJ-144 Color Thermal

**\$129**

## NEW AND FACTORY RECERTIFIED

4 YEAR EXTENDED WARRANTIES AVAILABLE ON MOST PRODUCTS

**CRA Systems, Inc. www.crasystems.com 800-375-9000**

CRA Systems, Inc. 300 South 13th St., Waco, TX 76701 Monday thru Friday 9AM to 7PM CST Saturday 10AM-4PM Sales Dept. Only  
Domestic Sales sales@crasystems.com Fax 254.750.9050 Consultants/Dealers 254.754.2120 International Sales 254.754.2120  
Prices reflect 2% cash discount. Prices subject to change. Not liable for typographical errors. Dealers and consultants call for quantity pricing. We ship anywhere.  
All Monitors, Printers, and CPUs are Factory Recertified unless otherwise stated. Call for latest pricing & availability on NEW Options.





# Never Send out for a Matchprint Again!

Amazing cost savings on full-bleed tabloid dye-sub printing!

Save **50%**  
While Supplies Last  
**\$6,995**

Also available in a full-page version for **\$2,995** (MSRP \$6,500)

Dealer inquiries welcome

### SUPERMAC ProofPositive

- Print full-bleed tabloid size
- Fine Line (reproduces 6 pt type)
- Adobe Postscript Level 2 RIP

### Advanced Trapping Feature:

ProofPositive prints true CMYK separations. This means that prints from ProofPositive shows all traps and overprints exactly as they will appear on press. Otherwise, what you see on a print is not necessarily what you'll see on press.

Also, the exclusive Pipeline buffer system allows for simultaneous ripping and printing to speed workflow in high-production environments.



~~MSRP \$14,000~~

Studiotronics price \$6,995

### Encad NovaJet III

- Print up to 20 feet long!
- Postscript RIP (Mac and PC)
- Two sets of 40ml ink refill bottles
- 300 dpi

**1/2 Price Sale!**



**\$3,795**

### Processor Upgrades

604e PowerPC w/MVP

- 200 MHz **\$375**
- 225 MHz **\$475**
- 233 MHz **\$549**



### Epson Stylus 3000

- 1440 dpi Photo-Quality Printing
- Adobe Postscript RIP
- Individual CMYK Ink Cartridges
- Prints 16 x 44"



**\$1,729**

### Authorized dealers of:

- Avid • Media 100 •
- Electric Image • A
- ple • Rhino • E
- id • Scitex
- Encad •



**studiotronics**

**800-653-1265**

All prices reflect a cash discount. Any other method is 2% higher.

voice: 510-689-9488 fax: 510-689-9487

PRICES & QUANTITIES SUBJECT TO CHANGE

Place Your Orders OnLine!

# 1-888-447-3728 • MacResQ • www.macresq.com

Toll Free  
Apple  
Stylewriter  
1200

w/ink & cable  
**\$89**



Mac OS

**PARTS, PARTS, PARTS!!**

CD 300i+ (tray) internal	\$49
CD 1200i (tray) internal -New	\$99
Phillips 8x internal cd rom	\$89
*mounting kits OR external cases avail.*	
Manual inject floppies (661-0121)**	\$49
Auto inject floppies (661-0474)**	\$79
PB 100 & 500 series floppies**	\$89
132 mhz PM processor upgrade cards	\$69
PowerBook Duo kybds (rev. F)-exch.	\$39
PM 6100 DOS cards	\$99

### MONITOR MADNESS!

90 day MacResQ warranty

Apple 14" Multi-scan	\$179
Apple 17" Multi-scan	\$499
Sony 17" OEM Trinitron	\$299
Sony 20" OEM Trinitron	\$499
Apple 21" Display	\$499

### Duo 2300c 28/1 gig/14.4

**\$999**

### Duo 280c 28/1 gig/14.4

**\$799**

Duo Dock II **\$299** (w/Duo purchase)

### POWER SUPPLIES:\*\*

LC thru Q 605	\$19
Mac II cx /ci / Q 700	\$49
Q 800 / PM 8100	\$99
PM 8500 / 9500	\$109
PERF. 630 thru 6300	\$69
Duo Dock	\$69
Q 900 / 950	\$99
PM 7100 (EXCH. ONLY)	\$69
PM 6100 (EXCH. ONLY)	\$89
II SI	\$49

### Software

**Special !!**

new! Apple

System 7.6

**\$18.99**

(on CD with

Int. Conn. Kit 1.2)

**MR**

Mac-Res-Q.

### PowerBook Screen Repair...only at MacResQ!

We can repair: scratched screens, bad pixels, lines, & dead screens- priced from **\$199**

call for more DETAILS!

25% re-stocking fee- ALL ITEMS REFURBISHED UNLESS NOTED AS NEW • All Parts Sold With a 90 Day MacResQ Exchange Warranty • \*\* = Exch. Required For Orders of 10 or Less • All Major Credit Cards With NO Surcharge.

CIRCLE 424 ON READER SERVICE CARD

Best Prices! Lifetime Warranty!

# DIMMs

32mb \$ 92 168 pin 64mb \$190

# SIMMs

16mb \$43 72 pin 32mb \$ 87

All prices are subject to change. Limited to stock on hand.

www.macsolutions.com

**(800)873-3RAM**

Tel: (310) 966-4444 Fax: (310) 966-4433

CIRCLE 426 ON READER SERVICE CARD

TOSHIBA FUJITSU OKI NEC  
MOTOROLA MICRON SAMSUNG MITSUBISHI

# memory

CALL FOR CURRENT BEST PRICES M-F 9-7PM SAT 10-5PM SUN 12-4PM EST

all items are new!  
lifetime warranty!  
TOP quality!

**1-800-832-8802**

OUR PRICES ARE THE BEST. NO MATTER WHAT'S BEEN ADVERTISED IN THIS MAGAZINE! MAKE SURE TO CALL US!

<b>SIMM</b> 16MB \$ 44 ea.	<b>DIMM</b> 16MB \$ 54 ea.
<b>SIMM</b> 32MB \$ 89 ea.	<b>DIMM</b> 32MB \$ 99 ea.
<b>SIMM</b> 64MB \$ 259 ea.	<b>DIMM</b> 64MB \$ 189 ea.

30pin 4MB SIMM \$15  
shipping from \$4

www.anweb.com  
CALL OR VISIT OUR STORE AT  
1221 WEST 6TH STREET STE.C AUSTIN, TX 78703  
PH. 512-474-2414 FAX 512-474-5514

VISA • Mastercard • Discover • CODs  
NO SURCHARGE FOR CREDIT CARDS  
prices subject to change

CIRCLE 400 ON READER SERVICE CARD

## MEMORY

Order Today & Save!

# FREE

SHIPPING  
MINIMUM ORDER REQUIRED

### The Best Deals in Memory

www.memory-tech.com

DIMMS EDO 3.3 EDO 5V PB3400  
32Mb \$ 99 \$ 99 \$105 \$161  
64Mb \$199 \$199 \$210 \$269

CALL OR SEE OUR SITE FOR COMPLETE LISTING  
We accept MasterCard, Visa, American Express, & Discover  
High Quality Lifetime Warranty • 2k Refresh  
Prices are subject to change Fax: 512/323-6394

**888-622-8355**



# Sonnet Smashes Power PC Prices!

## Sonnet Sonata Processor Cards

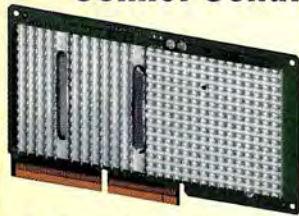

200MHz 604e **\$349**  
 225MHz 604e **\$399**  
 233MHz 604e **\$449**  
 240MHz 604e **\$499**  
 360MHz 604eMP **\$599**  
 400MHz 604eMP **\$699**

The Sonnet Sonata™ Power PC™ 604e processor upgrade cards are the most reliable, most cost-effective upgrades available. Modernize your Power Mac 7300, 7500, 7600, 8500, 8600, 9500, 9600 SuperMac J700 or S900 series. These power-packed upgrades are 100% compatible. Add multiprocessing for super-fast Adobe Photoshop, Premier, AfterEffects, and 3-D rendering. Add 1MB cache & double performance! MP multiprocessing by Daystar Digital. Resellers call.

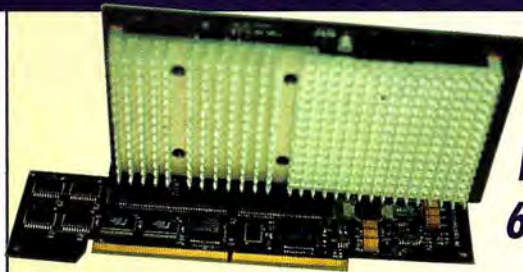

132MHz  
 604 for  
 PowerMac  
 6100... **\$399**

The Sonnet Crescendo™ accelerator speeds a Power Mac 6100 or Performa 611X to run as fast as the original Power Mac 9500! Upgrade the tired 60 or 66 MHz PowerPC 601 processor to a 120 or 132 MHz PowerPC 604 CPU, respectively. The Crescendo upgrade plugs into the PDS slot for easy user installation.

**New!**

Run System 8 and all applications faster than you ever thought possible for much less than the cost of a new machine. Resellers call.

## Cache Speeds!

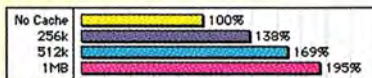

A Power Mac with 1MB cache runs twice as fast as cache-less (200MHz 604e, MacBench 4). A cache card is the most cost-effective performance upgrade you can make. We build 'em and have the lowest volume prices. Resellers call.

256K	6100/7100/7200/7500/8500.....	\$49	5260.....	\$99
512K	7200/7300/7500/7600/8500/8600.....			\$69
1M	6100/7100/7200/7300/7500/7600/8100/8500/8600.....			\$149
256K	4400/5400/5500/6360/6400/6500/StarMax.....			\$65
512K	4400/5400/5500/6360/6400/6500/StarMax.....			\$95
1M	4400/5400/5500/6360/6400/6500/StarMax.....			\$199



Accelerate Mac LC,  
 LC II, Color Classic,  
 IICI, IISI, IIvx, IIvi, IIx,  
 IIcx, or Performa 600 to  
 '040 Speed **\$149-\$299**

Sonnet Presto™ LC 040 50/25 MHz accelerators increase Mac LC, LC II, or Color Classic performance 500% as fast as a stock machine. Use RAM Doubler or Virtual Memory and break the 10MB barrier (except Mac LC). Presto LC is \$149, with FPU \$199.

**Run System 8!** The 80/40MHz version for the Mac IICI, IISI\*, IIvx, IIvi, IIcx\*, IIx\* or Performa 600 increases processor performance up to 500%. The 80/40 MHz Presto at only \$199 includes 128K level 2 cache, or \$299 with FPU too. (\*Adapter required)

Prestos are 100% software compatible and run Systems 7 or 8 (LC, IIx, IIcx Sys7 only). Prestos are easy to install in Macs' processor direct slot.

33 MHz 68030 Allegros  
 Accelerate Mac SE, SE/30,  
 II, LC, LC II Color Classic from **\$99**



The Allegro™ LC for the Mac LC, LC II, Color Classic doubles your cpu speed, adds 16K level 2 cache and includes an FPU—all for only \$99! The Allegro SE increases performance 460%, includes an FPU and 4 SIMM slots to expand memory up to 16MB for a bargain \$199. Allegro Mac II, SE/30 are \$99.

Run System 8  
 on a Quadra  
 Twice as Fast!



**\$149-\$299**

Plug the Sonnet QuadDoubler™ into a Quadra 610, 660av, 700, 900, or Centris 610\*, 660av, 650 and run virtually twice as fast as before for only \$299. The QuadDoubler is System 8 compatible! Just plug the QuadDoubler into your CPU socket and power up your Mac. A CPU extraction tool is even included to simplify installation. The QuadDoubler includes a Floating Point Unit for superfast rendering or calculations. \*The Centris 610 QuadDoubler runs at 80/40 MHz and is value-priced at \$199 (without FPU \$149).

Add Math Coprocessor to  
 68040 Macs & PowerBooks



Give your Quadra, Centris, or PowerBook 520/540 a math coprocessor for internet file decompression, rendering, or Photoshop. 25MHz 68040 \$125\*, 33MHz 68040 with heat sink \$169\*. Add a full 66/33MHz 68040 with FPU to your PowerBook 520 or 540 for \$199\*. This also speeds 520 to 66/33MHz. Call for PB190, Duo280 FPU. \*68LC040 trade-in req'd.



SONNET TECHNOLOGIES, INC.  
 18004 Sky Park Circle, Irvine, California 92614  
 714-261-2800 Fax 261-2461 sales@sonnettech.com

**800-786-6260**

<http://www.sonnettech.com>



VISA and MasterCard no surcharge. We used to have a surcharge; we don't anymore. Government, corporate and education P.O. welcome. Tom manages the helpful sales team. He likes to emphasize customer service, swim and play the guitar. One year limited warranty on all products. If you stop on it and break it we limit the warranty, otherwise we don't limit it too much. All returns require an authorization and are subject to a restocking fee. ©1997 Sonnet Technologies, Inc. Sonnet, the Sonnet Logo, Allegro, Crescendo, Presto, QuadDoubler, and Sonata are trademarks of Sonnet Technologies.

CIRCLE 405 ON READER SERVICE CARD



**Shadow Technologies**  
(800) 4-SHADOW  
800-474-2369

Hours: M-F 9-5  
Sat 9-5  
PST

**PowerBook Memory**

**PB 3400**  
16M/32M/48M/64M/128M  
\$79/\$142/\$238/\$279/\$619

**PB 2400**  
8/16/32/64M 2K  
\$49/79/149/309

**PB 2300 DUO**  
20M/28M/40M  
\$129/\$148/\$219

**PB 190**  
16M/32M/48M  
\$79/\$142/\$229

**72 pin SIMMs**  
5V FP/EDO - 60 ns  
4/8/16MB \$15/24/42  
32/64MB \$86/248

**30 pin - 60 ns**  
4/8/16MB  
\$18/39/62

**168 pin DIMMs**  
5/3.3V FP/EDO-60ns  
8/16/32MB \$33/53/96  
64/128MB \$189/585  
SDRAM-10 ns/100 ns  
16/32/64/128MB  
\$63/108/209/643

**PPC** 180 to 360 / 604e  
PMac 7300-9600 / Altos  
CPU Upgrades Available for \$Call  
Other Mac's & Shipping is FREE!!

**Cache** 256K SIMM \$12  
512K SIMM \$18  
1M DIMM 72-86 \$21  
2M ATI 9500 \$69  
2M EDO StarMax \$29  
2M SGRAM SMax \$39  
4M SGRAM SMax \$59

**VIDEO RAM**

**L2 New!**

**StarMax**

**Call for Volume Discounts**  
Govt. Edu/Corp. PO's OK with Approved Credit

**Verification of Address Used to Prevent Credit Fraud**  
No Surcharge

**MAC Solutions**

**Low Price Guarantee:** If ANY advertiser offers a lower price on comparable modules (new, late date code, name brand chips) Shadow will strive to BEAT their best price by 2 - 5%!  
Call us LAST and SAVE!!

**MEMORY** Macs/Clones/Laptops

**CPUPGRADE** PowerPC Accelerator

# MEMORY

Lifetime Warranty!  
**BEST PRICES!**  
Apple® Authorized Value-Added Reseller

**SDRAM Call!!**

168 Pin DIMMs	SIMMs 72 & 30 pin	Specials
16mb \$ 52	72 4mb/8mb \$ 15/24	GV 56k Modems \$ 165
32mb \$ 92	72 16mb/32mb \$ 43/87	GV 56k PCMCIA \$ 235
64mb \$ 190	30 2mb/4mb \$ 13/15	lomega Zip Drive \$ 140
EDO/3.3VEDO \$CALL	30 8mb/16mb \$ 43/62	lomega Jaz Drive \$380
		lomega Zip 10 pk \$ 125
		lomega Jaz Cart \$ 85
		Quantum 2.1 gb \$245
		Quantum 3.2 gb \$ 310
		Quantum 4.3 gb \$360

**PBook 5/53/14/34**

**Cache/VRAM**

16mb \$ 83 61/71/81 256k \$ 12  
24mb \$ 137 64/54 256k \$ 60  
32mb \$ 160 72/76/85 512k \$ 75  
64/128 3400 \$ 285/595 1 mb VRAM \$ 22

All prices are subject to change. Limited to stock on hand. #100

**WE BUY, SELL & TRADE MACS!**  
CALL (800)80-WE-BUY

11933 Wilshire Blvd, West Los Angeles, CA 90025  
Tel: (310) 966-4444 Fax: (310) 966-4433  
www.macsolutions.com  
University & School P.O.'s Welcome  
VISA-Discover/MC-AMEX no surcharge

**MAC Solutions** (800) 873-3RAM

CIRCLE 404 ON READER SERVICE CARD

## Best Prices

### RAM Modems Drives & More

Baber Information Services, Inc.  
http://www.baber.com/mac/  
**800-290-0189**

CIRCLE 402 ON READER SERVICE CARD

We Manufacture **MEMORY**

**BUY DIRECT!  
SAVE MONEY!**

**DIMMS 5v / 3.3v**  
32MB \$123 / \$128  
64MB \$239 / \$255

**SIMMS 72pin SIMMS 30pin**  
16MB \$62 4MB \$21  
32MB \$112 16MB \$65

**PowerBooks**  
3400-32MB \$195 1400-24MB \$167  
190-24MB \$160 5300-16MB \$100  
Prices are subject to change

Visit our Website for  
Complete Up-to-Date Price List  
[www.apcom.com/acl](http://www.apcom.com/acl)  
[www.cybertechmall.com/kpo](http://www.cybertechmall.com/kpo)

ACL, INC. 21555 Bering Dr., San Jose, CA 95131  
**800-888-0348**

CIRCLE 401 ON READER SERVICE CARD

**Digitek**  
www.macstuff.net

**Mac Gifts  
Under \$50**

**Call Toll Free  
888-699-8787**

**WHY IS THE COMPETITION SHAKING?**

BECAUSE

**1-800-4-MEMORY**

IS HERE

**WE CAN BEAT**

ANY QUOTED PRICE ON ANY MEMORY FOR ANY COMPUTER (NOTEBOOK, DESKTOP, PRINTERS) ANYWHERE... PERIOD!

- LIFETIME WARRANTY
- FREE TECH SUPPORT
- NO CREDIT CARD SURCHARGE
- MOST ORDERS SHIPPED SAME DAY

**CALL AROUND THEN CALL US**

CHECK OUR WEB SITE FOR SPECIALS  
[WWW.18004MEMORY.COM](http://WWW.18004MEMORY.COM)



# DMS MAC & PC MEMORY

**LIFETIME MEMORY REPLACEMENT GUARANTEE**  
**30 DAY MONEY BACK GUARANTEE**

**Data Memory Systems**  
24 Keewaydin Dr.  
Salem, NH 03079  
Tel: 603-898-7750  
Fax: 603-898-6585  
E-mail: sales@datamem.com



**DMS WILL NOT BE UNDERSOLD ON MEMORY PRODUCTS**

- SIMMs •DIMMs •SDRAM •VRAM
- EDO Memory •CACHE
- Printer Memory •Modems
- Network Products
- PowerBook & Notebook Memory Upgrades

Hubs & Connectors



Mac & PC to TV



NewerTECH



28.8Kbps  
33.6Kbps  
56Kbps!



iomega Zip & Jaz Drives



Zip & Jaz Disks

ORDER ON-LINE 24 HOURS @ <http://www.datamem.com/macworld>

**CALL 1-800-662-7466 TOLL FREE**

University, Government & Corporate P.O.s with Approved Credit

CIRCLE 403 ON READER SERVICE CARD

# DRIVES MEMORY

**Quantum** 3/5 Year Warranty!

**2.1 Gig Stratus**  
5400rpm/10ms Ultra SCSI 3

**\$225**  
ST532150

3.2 GB Stratus	10ms	5400	US3	STS3324	\$299
4.3 GB Stratus	10ms	5400	US3	STS3432	\$349
6.4 GB Stratus	10ms	5400	US3	STS3648	\$449
4.5 GB Atlas II	8.0ms	7200	US3	ALS3455	\$595
9.1 GB Atlas II	8.0ms	7200	US3	ALS34550	\$855

**Seagate** 5 Year Warranty!

9.1 GB Barracuda	8ms	7200	F520	ST19171N	\$889
4.5 GB Cheetah	8ms	10000	US3	ST34501N	\$795
23 GB Elite	8ms	10000	US3	ST423451N	\$1995

**IBM** 5 Year Warranty!

9.1 GB UltraStar	8.5ms	7200	US3	IBM91US	\$789
9.1 GB UltraStarWIDE	8.5ms	7200	US3	IBM91USW	\$799

**MICROPOLIS** 5 Year Warranty!

2.1 GB	9ms	5400	US3	MC4321	\$229
4.5 GB	7.9ms	7200	US3	MC4345	\$695
9.1 GB	8.5ms	7200	US3	MC3391	\$849

**Western Digital** 5 Year Warranty!

2.1 GB Enterprise	8ms	7200	US3	WDE2170	\$269
4.3 GB Enterprise	8ms	7200	US3	WDE4360	\$799

**PROCESSOR UPGRADES**

PPC604e 180Mhz	\$279
PPC604e 200Mhz	\$359
PPC604e 225Mhz	\$429
PPC604e 233Mhz	\$469
PPC604e 240Mhz	\$499
PPC604e 250Mhz	\$539
DUAL 604e's 400Mhz	\$799
DUAL 604e's 450Mhz	\$899
DUAL 604e's 500Mhz	\$1099
G3* 250Mhz w/112K/2/125Mhz	\$1299
G3* 266Mhz w/112K/2/177Mhz	\$2199
G3* 250Mhz w/112K/2/250Mhz	\$2399
G3* 275Mhz w/112K/2/275Mhz	\$2999

**SOURCE TECHNOLOGIES**

**800-900-4599**  
<http://www.sourcetechnologies.com>  
Voice 954-725-9777 • Fax 954-725-9977

All products feature a 30 day money back guarantee. All memory products are brand new and carry a limited lifetime warranty. Government and educational PO's are welcome. No surcharges on credit cards. Prices are subject to change without notice! \*Free FedEx Shipping is a limited time offer - restrictions apply!

**\*FREE FEDEX SHIPPING!**

**LIFETIME WARRANTY!**

**SIMMS 72 Pin 60/70ns** **DIMMS 168 Pin /EDO 3.3**

4MB	\$15	8MB	\$37/39
8MB	\$27	16MB	\$55/59
16MB	\$47	32MB	\$103/115
32MB	\$97	64MB	\$199/209

**30 PIN SIMM 60/70ns** Lifetime Warranty!

1 MB	\$9
2 MB	\$14
4 MB	\$21
16MB	\$75

**POWERBOOK RAM 500/5300/190** Lifetime Warranty!

4 MB	\$45
8 MB	\$57
16 MB	\$87
32 MB	\$149
48 MB	\$239

**PB 1400/2400/3400...INSTOCK!!! \$CALL!**

**L2 CACHE** Lifetime Warranty!

256k-61/71/81xx	\$13
256k/512k-72/73/75/76/85xx	\$45
256k/512k-44/54/64/65xx	\$59/79
1MB-61/71/81xx	\$125
1MB-72/73/75/76/85/86	\$155

**VRAM** Lifetime Warranty!

256k/512k VRAM Q/C/71/81	\$13/19
1MB Powermac	\$21
2MB/4MB ATI/STARMAX	\$55/79

**LOWEST PRICES GUARANTEED!!!**

CIRCLE 406 ON READER SERVICE CARD







**DATA RECOVERY: 800-440-1904**

**7 good reasons to choose DriveSavers:**



1. We're the most trusted and respected data recovery specialists.
2. 24-hour, onsite, and weekend service available.
3. Proprietary techniques so advanced we retrieve data others might simply abandon.
4. Over 12 years of data recovery experience.
5. Certified to maintain most drive warranties.
6. Featured by CNN, NextStep, C-Net, Forbes.
7. All storage devices; DOS, Win95, WinNT, OS/2, Mac OS, UNIX, Sun, SGI, Novell.

©1997 DRIVESAVERS, INC.

Clip and save this ad. Visit DriveSavers at: [www.drivesavers.com](http://www.drivesavers.com)

DRIVESAVERS, INC. 400 BEL MARIN KEYS BLVD., NOVATO, CA 94949, INTL.: 415-382-2000, FAX: 415-883-0780

CIRCLE 453 ON READER SERVICE CARD

**Data Recovery in hours.**

- Over 10 years of experience with clients worldwide including Apple, NASA, HP, and FedEx.
- We've recovered more than half-a-million megabytes of Mac Data alone.
- You only pay when there's a recovery.
- Express One-Day Service is available.
- Call 24 hours a day.

415-495-5556 • FAX 415-495-5553 • RESTRICTIONS MAY APPLY  
381 Clementina Street • San Francisco, California 94103

**LAZARUS**  
DATA RECOVERY  
Working at the speed of business.  
**800-341-DATA**

CIRCLE 454 ON READER SERVICE CARD

**PROFESSIONAL DATA RECOVERY SERVICES.**

Hard Drives, Floppy Drives, Syquest, EZ-135, ZIP, JAZ, Optical & Bernoulli.

**TOTAL RECALL**  
THE DATA RECOVERY COMPANY



**800 743-0594** VISIT US AT [www.recallusa.com](http://www.recallusa.com)

2482 WAYNOKA ROAD • COLO. SPRINGS, CO 80915 • TEL (719) 380-1616 • FAX (719) 380-7022

CIRCLE 456 ON READER SERVICE CARD

**ONTRACK UNVEILS REMOTE DATA RECOVERY TECHNOLOGY**

Ontrack Data Recovery, the leading provider of data recovery services, will be introducing **ONTRACK RDR™ Remote Data Recovery** technology at COMDEX through interactive demonstrations. This new offering will allow ONTRACK to perform fast and complete data recovery services directly on your computer via modem link.



See us at COMDEX booth # S7716

**Ontrack**  
Defining Data Recovery Solutions Worldwide  
1.800.872.2599  
[www.ontrack.com](http://www.ontrack.com)

Stop by booth # S7716 at COMDEX to get a free copy of Data Advisor™ data loss diagnostic software or visit our website to download your free copy!

©2001 ONTRACK Data International, Inc.

CIRCLE 455 ON READER SERVICE CARD

**WE SPECIALIZE IN WHOLESALE WATERLESS COLOR PRINTING**

**1000 FULL COLOR BUSINESS CARDS FOR \$100** Sug. retail price \$179  
**1000 FULL COLOR POSTCARDS FOR \$149** Sug. retail price \$249

Printed waterless at 300 line screen from your computer files on Super Premium 10pt. Kromekote with our FREE scratch-resistant aqueous coating.

**1st BLUE ROCK GRILL**  
Scott Gardner  
Bar Manager  
2405 State Street • Suite F

Down to Earth Food

- BUSINESS CARDS
- POSTCARDS
- CD INSERTS
- CD TRAY LINERS
- BROCHURES
- BOOKLETS
- NEWSLETTERS
- POSTERS & MORE

Illustration  
Image Editing  
3D Animation  
Graphic Design  
Highland Piping

David Mackay Ballard  
156 Lynton Rd.  
Berlin, MA 01503  
Tel. 978/ 838 2125  
Fax. 978/ 838 0281

**MacEYE**  
GRAPHICS  
e-mail: [dballard@tomorrowvision.com](mailto:dballard@tomorrowvision.com)  
<http://www.tomorrowvision.com>

Save Money!  
Upload Your Files to Our FTP Site at [ftp.copycraft.com](http://ftp.copycraft.com)

**FEATURING 300 LINE SCREEN WATERLESS OFFSET PRINTING**

Rates for Brochures, Booklets and Flat Sheets are also available.

**4-COLOR WATERLESS SPECIAL** **1000 Presentation Folders** **\$1489**  
9" x 12" 4-color folders with 4" pockets and BC slit printed from your files at 300 line screen on 10 Pt. Kromekote with Free Aqueous Coating.  
**Get 2,000 for only \$2199** SUGGESTED RETAIL \$2999

GRAPHIC ARTS AVAILABLE



**Copy Craft**  
PRINTERS, INC.

4413 82nd Street • Lubbock, TX 79424 • FAX: 806.794.1305

**QUARK!**  
Authorized Service Bureau

Factory Authorized **COREL** Service Bureau

Email your requests for printing quotes to [request@copycraft.com](mailto:request@copycraft.com)

**1.800.794.5594**

CALL TODAY FOR A FREE COPY OF OUR NEW FULL COLOR CATALOG

Visit <http://www.copycraft.com> for more 4-Color Specials!

CIRCLE 450 ON READER SERVICE CARD



# DIRECTORY

## ACCOUNTING SOFTWARE

### COMPLETE BUSINESS SOLUTIONS

One-stop shop for hardware, software, financing and services for any size business. Our accounting programs range from basic to sophisticated multi-user systems plus Point of Sale, Inventory, Pricing and Payroll packages. Call for a catalog or e-mail us at [info@maxworld.com](mailto:info@maxworld.com).

**MAX COMPUTERS • (800) 656-6299**

1506 25th Street, San Francisco, CA 94107  
<http://www.maxworld.com/accounting> • Fax (415) 695-0257

CIRCLE 459 ON READER SERVICE CARD

## COMPUTER INSURANCE

### INSURES YOUR MAC

The Computerowners™ insurance policy repairs or replaces hardware, media and purchased software. \$49 a year covers up to \$2,000 of equipment against theft, fire, accidents, power surge, natural disasters and more! \$50 deductible. Call for immediate coverage or information. 1-800-800-1492.

**SAFWARE, The Insurance Agency, Inc.**

5620 N. High Street, PO Box 656  
Columbus, Ohio 43085

CIRCLE 462 ON READER SERVICE CARD

## DIRECTORY CONTACTS 800.825.4237

### ADVERTISING REPRESENTATIVES

Michelle LeWinter	<a href="mailto:mlewin@zcd.com">mlewin@zcd.com</a>	x5122
Eric Birnbaum	<a href="mailto:ebirnbaum@zcd.com">ebirnbaum@zcd.com</a>	x5043
Morifa Kelly	<a href="mailto:mkelly@zcd.com">mkelly@zcd.com</a>	x5155
Jessica Turko	<a href="mailto:jturko@zcd.com">jturko@zcd.com</a>	x5140
Isala Beatty	<a href="mailto:lbeatty@zcd.com">lbeatty@zcd.com</a>	x5153

### ADVERTISING SALES MANAGER

Thomas Foran [thomas\\_foran@zcd.com](mailto:thomas_foran@zcd.com) x5145

### DIGITAL ADVERTISING COORDINATOR

Brian Mullin [brian\\_mullin@macworld.com](mailto:brian_mullin@macworld.com)  
(415) 267-1735

## BUSINESS OPPORTUNITIES

### Personal Computer Owners

Personal computer owners can earn \$1000 to \$5000 monthly selling simple services that are performed by your personal computer. Work at home in your spare time. FREE list of 100 best services to offer.

Write or call:

**C. O. B. I. Y.**

P.O. Box 12107, La Jolla, CA 92039  
Call 24 hrs: 800-714-2332 Ext. 145

CIRCLE 460 ON READER SERVICE CARD

## DISK DUPLICATION

### CD-ROM MASS-REPLICATION

- Quantities from 500 discs to 10,000,000 +
- ISO 9000-certified manufacturing
- Complete, innovative printing & packaging: cardboard, Tyvek®, & jewel-box packaging options available.

### OASIS® DUPLICATION

Contact Micah Solomon, President directly:  
[micah@oasiscd.com](mailto:micah@oasiscd.com) • 800/697-5734  
Fax 540/675-2500 • FLint Hill, VA 22627

CIRCLE 463 ON READER SERVICE CARD

## GENEALOGY SOFTWARE

### REUNION® 5- New upgrade!

BETTER THAN EVER! Sound & video, Web publishing, drag-and-drop editing. Unlimited individuals, events, facts, and sources. Create large wall charts: Ancestor and Descendant, plus new Relative and Timeline charts with photos - great for family reunions. To order call MacWarehouse 800-255-6227. Visit our Web site: [www.LeisterPro.com](http://www.LeisterPro.com)

### LEISTER PRODUCTIONS

P.O. Box 289 Mechanicsburg, PA 17055  
tel: (717)697-1378 • e-mail: [info@LeisterPro.com](mailto:info@LeisterPro.com)

CIRCLE 465 ON READER SERVICE CARD

## RELIGION

### Bible Study on Disk or CD-Rom

Full Featured. Fast & Friendly Bible study software. As the leader in Bible study software since 1981 we have continued to listen to our customers and provide them with the tools they need. Call for a FREE catalog. <http://www.brs-inc.com/bible>

### BIBLE RESEARCH SYSTEMS

2013 Wells Branch Pkwy. #304, Austin, TX 78728  
(800) 423-1228 (512) 251-7541

CIRCLE 467 ON READER SERVICE CARD

## CD ROM

### CD-ROM Production Services

- All formats: Mac, ISO, Hybrid, Mixed Modes
- Premastering, beta testing, or archiving
- Mass Replication available, any quantity
- Personal, Knowledgeable Service for 10 Years!
- Certified Apple Developer • Low prices/fast delivery

### NORTHEASTERN DIGITAL RECORDING

2 Hidden Meadow Ln, Southboro, MA 01772  
508-481-9322 Fx:508-624-6437 CDNDR@aol.com

CIRCLE 461 ON READER SERVICE CARD

## DRIVE SALES & REPAIRS

### FLOPPY DRIVE REPAIR & SALES

Mac 3.5" 400K, 800K, & 1.44 MEG (Repair) . . . \$40.00  
Advanced Exchange . . . . . From \$40.00  
New & Refurbished Hard Drive & Floppy Drive Sales. Call Price includes most parts, cleaning & alignment. 1yr warranty on repair, 2yrs on new drives. Schools + Gov't. PO's accepted. Expert Data Recovery.

### UPTIME COMPUTER SUPPORT SERVICES

<http://www.scvnet.com/~uptime> • 23633 Via Primero  
Valencia, CA 91355 • 805-254-3384 • Fax 805-254-1950

CIRCLE 464 ON READER SERVICE CARD

## POWERBOOK BATTERIES & RAM

### Your Best Battery & RAM Source!

From PB 100 to 3400, Mac Plus to Power Mac 9600, Erudite has what you need at prices that won't slow you down. We feature power products from BTI and Absolute, memory and 56K modems from Viking - all new & fully warranted. Call, e-mail or shop online for your best price! Visa/MC/Amex/Discover Accepted.

### ERUDITE PRODUCTS CORP.

409 Grand Ave., Englewood, NJ 07631 800-310-8505  
E-Mail: [sales@EPC-Online.com](mailto:sales@EPC-Online.com), [www.epc-online.com](http://www.epc-online.com)

CIRCLE 466 ON READER SERVICE CARD

## RELIGION

### ONLINE BIBLE CD

"Fast, Full Featured and Affordable"

"The standard by which all others are judged"

NIV NASB NKJV NRSV KJV w/Strongs + others  
Lexicons, X-Refs, Topics, Dicts, Commentaries, Maps  
Deluxe CD \$90 Classic CD \$40

### BY THE NUMBERS, INC. • (800) 554-9116

RR 1 Box 75 Sutton NH 03221-9301  
[www.bythenumbers.com](http://www.bythenumbers.com)

CIRCLE 468 ON READER SERVICE CARD

**Buy smart with Macworld Lab.**

**MACWORLD LAB TEST**

To buy smart when you're choosing Mac OS hardware or software, you've got to put it to the test. Macworld Lab is on the job. testing, scrutinizing, and evaluating the performance and quality of the products you need. With real-world testing, we measure performance by real-life standards. Using the system and applications you'd use to complete the tasks you're faced with every day, our experts come up with answers that matter to you.

You can rely on Macworld Lab Test results — We test the products the way you use them.

**Macworld**  
THE ESSENTIAL MACINTOSH® RESOURCE

"A Macworld never goes by without me checking to compare prices. I always look to see if what I need is there."  
—Owner, Computer Consultants

\*Source: Harvey Communication Measurement report, January 1995

**Macworld**  
SHOPPER



# Macworld

IN NEW YORK AT



**GET CREATIVE WITH YOUR MACINTOSH!**

# Macintosh Holiday Showcase

ENTER TO  
WIN FREE  
PRIZES!

**G**et inspired and learn something new every day at this special four-day extravaganza—from Thursday, Dec. 4 to Sunday, Dec. 7! Drop by and learn how to get the most out of your Mac. Get tutorials on the hottest Mac titles from leading software companies like Apple, Microsoft, IBM, MetaCreations, Claris and more. Meet with the experts from *Macworld* magazine. Plus, demo products all around the store from the latest Mac games to the coolest laptops from Apple. You can also enter to win **FREE** prizes and giveaways! So mark your calendar for the Macintosh Holiday Showcase—Do it now!

### A Special Four Day Extravaganza!

- Daily In-Store Demos
- FREE Workshops on the Mac
- Special Theme Events
- Prizes and Giveaways

### Demo the latest...

- Digital Cameras
- Kids Software
- Games for the Holiday Season
- And More!



15 Park Row  
New York, NY 10038

Call 212/238-9000 for information

### Special Events Include:

#### THURSDAY, DECEMBER 4

##### **Playing and Composing Music On your Mac**

- "Music Creation" by G-Vox
- "CD-ROM Creation" by Philips
- Learn how to play the guitar

#### FRIDAY, DECEMBER 5

##### **Games and Entertainment On your Mac**

- "Gaming and Edutainment" by IBM
- Demo the best Mac games like Riven and Duke Nukem 3D
- Test the latest gamepads and joysticks

#### SATURDAY, DECEMBER 6

##### **Your Macintosh Home Workshop**

- "ClarisWorks for Kids" by Claris
- "MacOS8, Features and Benefits" by Apple
- Create your own web page



continued from page 194

"Bartender!" shouts Steve. "You don't have a copy of *Wired* here, do you? I've got to read up on this crazy reality!"

The bartender glares. "I don't know what you're wired on, pal, but either stop talking crazy or get outta my shop."

"No such thing as *Wired*," whispers Claris. "Never was. Before you wished the Mac away, most magazines were produced entirely on the Mac. Besides, *Wired* would be awfully thin without the Web."

"Without the—now, wait just a minute!" Horrified, Steve rushes over to one of the PCs and connects to the Internet. "You call this the Net? It looks like a text-only BBS—and there's practically nobody online! Where's Navigator? Where's Internet Explorer? Where's the *Web*, for Pete's sake?"

"Oh, I see," Claris smiles sympathetically. "You must be referring to all those technologies that spun off from the concept of a graphic interface. Look, Steve. Until the Mac made the mouse standard, there was no such thing as point and click. And without clicking, there could be no Web . . . and no Web companies. Believe it or not, Marc Andreessen works in a

Burger King in Cincinnati."

Steve scoffs. "Well, look, if you apply that logic, then PageMaker wouldn't exist either. Photoshop, Illustrator, FreeHand, America Online, digital movies—all that stuff began life on the Mac."

"You're getting it," Claris says. He holds up a copy of *Time* magazine. "Check out the cover price."

Steve gasps. "*Eight bucks?* They've got a lot of nerve!"

"Labor costs. They're still pasting type onto master pages with hot wax."

"You're crazy!" screams Steve. "I'm going back to my office at Apple!" He drives like a madman back to Cupertino—but the sign that greets him there doesn't say, "Welcome to Apple." It says, "Welcome to Microsoft South."

"Sorry, Steve; Apple went out of business in 1985," says Claris. "You see, you really did have a wonderful machine! See what a mistake it was to wish it away?"

Steve is sobbing, barely listening. "OK, then—I'll go to my office at Pixar!"

"You don't *have* an office at Pixar," Claris reminds him. "There was no Mac to make you rich enough to *buy* Pixar!"

Steve has had enough. He rushes

desperately back to the icy bridge over the river. "Please, God, bring it back! Bring it back! I don't care about market share! Please! I want the Mac to live again!"

Music, wind, heavenly voices—and then snow begins softly falling.

"Hey, Steve! You all right?" calls out Steve's friend Larry from a passing helicopter. Steve pats his pocket—the Newton is there again! It's all back! Steve runs through the town, delirious with joy. "Merry Christmas, *Wired!* Merry Christmas, Internet! Merry Christmas, wonderful old Microsoft!"

And now his office is filled with smiling people whose lives the Mac has touched. There's old Mr. Chiat/Day the adman. There's Gianni the musician. And there's Mr. Spielberg the moviemaker. As the Apple board starts singing "Auld Lang Syne," somebody boots up a Power Mac.

Steve smiles at the startup sound. "You know what they say," he tells the crowd. "Every time you hear a startup chime, an angel just got his wings." ■

DAVID POGUE's latest book is *The Microcloth Joke Book* (Berkeley, 1997). If the World Wide Web still exists, his home page is [www.poguelman.com](http://www.poguelman.com).

January 1998, Volume 15, Number 1 Macworld (ISSN 0741-8647) is published monthly by Mac Publications, L.L.C. Editorial and business offices: 501 Second St., San Francisco, CA 94107, 415/243-0505. Subscription orders and inquiries should be directed to 303/665-8930. Subscription rates are \$27 for 12 issues, \$54 for 24 issues, and \$81 for 36 issues. Foreign orders must be prepaid in U.S. funds with additional postage. Add \$18 per year for postage for Canada and Mexico subscribers. Add \$69 per year for postage to all other countries. Periodicals postage paid at San Francisco, California, and at additional mailing offices. Postmaster: Send address changes to Macworld, P.O. Box 54529, Boulder, CO 80328. Printed in the USA.

# Buy smart with Macworld Lab.

## MACWORLD LAB TEST

**Macworld**  
LAB TEST

To buy smart when you're choosing Mac OS hardware or software, you've got to put it to the test. Macworld Lab is on the job, testing, scrutinizing, and evaluating the performance and quality of the products you need. With real-world testing, we measure performance by real-life standards. Using the system and applications you'd use to complete the tasks you're faced with every day, our experts come up with answers that matter to you.

You can rely on Macworld Lab Test results — We test the products the way you use them.

**Macworld**  
THE ESSENTIAL MACINTOSH® RESOURCE



# The Desktop Critic

by David Pogue

## It's a Wonderful Machine

THE SWEETEST CHRISTMAS MOVIE FRANK CAPRA NEVER MADE

I GUESS I SHOULDN'T HAVE gone to a party where the eggnog was spiked, and maybe I shouldn't have watched the movie *It's a Wonderful Life* while leafing through *MacWeek*. But anyway, I had the *weirdest* dream last night—like a bizarre black-and-white movie that went like this: Jimmy Stewart stars as Steve “Jobs” Bailey, who runs a beleaguered but beloved small-town computer company. For years, big monopolist Bill “Gates” Potter has been wielding his power and money to gain control of the town. And for years, Steve has fought for survival: “This town needs my measly, one-horse computer, if only to have something for people to use instead of Windows!”

But now an angry mob is banging on Apple's front door, panicking. “The press says your company is doomed!” yells one man. “You killed the clones! We're going to Windows!” calls another. “We want out of our investment!” they shout.

Steve, a master showman, calms them. “Don't do it! If Potter gets complete control of the desktop, you'll be forced to buy his bloatware and pay for his cruddy upgrades forever! We can get through this, but we've got to have faith and stick together!” The crowd decides to give him one more chance.

But the day before Christmas, something terrible happens: On his way to the bank, the company's financial man, Uncle Gilly, somehow manages to lose \$1.7 billion. With eyes flashing, Steve grabs the befuddled Gilly by the lapels. “Where's that money, you stupid old fool? Don't you realize what this means? It means bankruptcy and scandal! Get out of my company—and don't come back!”

Desperate and afraid, Steve heads to Martini's, a local Internet café, and drowns his sorrows in an iced cappuccino. Surfing the Web at one of the café's Macs, all he finds online is second-

guessing, sniping by critics, and terrible market-share numbers.

As a blizzard rages, Steve drives his car crazily toward the river. “Oh, what's the use?!” he exclaims. “We've lost the war. Windows rules the world. After everything I've worked for, the Mac is going to be obliterated! Think of all the passion and effort these last 15 years—wasted! Think of the billions of dollars, hundreds of companies, millions of people . . .” He stands on the bridge, staring at the freezing, roiling river below—and finally hurls himself over the railing.

After a moment of floundering in the



chilly water, however, he's pulled to safety by a bulbous-nosed oddball. “Who are you?!” Steve splutters angrily.

“Name's Clarence—I mean Claris,” says the guy. “I'm your guardian angel. I've been sent down to help you—it's my last chance to earn my wings.”

“Nobody can help me,” says Steve bitterly. “If I hadn't created the Mac, everybody'd be a lot happier: Mr. Potter, the media, even our customers. Hell, we'd all be better off if the Mac had *never been invented at all!*”

Music swirls. The wind howls. The

tattoo on Steve's right buttock—Buzz Lightyear from *Toy Story*—vanishes.

Steve pats the empty pocket where he usually carries his Newton. “What gives?”

“You've got your wish,” says Claris. “You never invented the Mac. It never existed. You haven't a care in the world.”

“Look, little fella, go off and haunt somebody else,” Steve mutters. He heads over to Martini's Internet café for a good stiff drink. But he's shocked at the difference inside. “My God, look at the people using these computers! Both of them—they look like math professors!”

“They *are*,” says Claris.

“What is this, a museum? It looks like those computers are running DOS!”

“Good eye!” says Claris. “DOS version 25.01, in fact—the very latest.”

“I don't get it,” Steve says.

“DOS is a lot better and faster these days, but it hasn't occurred to anybody to market a computer with icons and menus yet. There's no such thing as Windows—after all, there never was a Mac interface for Microsoft to copy.”

“But this equipment is ancient!” Steve exclaims. “No sound, no CD-ROM drive, not even 3.5-inch floppies!”

“Those aren't antiques!”

Claris says. “They're state-of-the-art Compaqs, complete with the latest 12X, 5-inch-floppy drives. Don't forget, Steve: The Mac introduced and standardized all that good stuff you named.”

“But that's nuts!” Steve explodes. “You mean to tell me that the 46 percent of American households with computers are all using *DOS*?”

“Correction: All 9 percent of American households,” says Claris cheerfully. “Without a graphic interface, computers are still too complicated to be popular.”

*continues on page 193*



# I am...

Discover Creator2, drawing and page layout software made expressly for designers. This streamlined software is tailored to the way you work, providing the freedom to tinker, rearrange, and adjust your designs to achieve the perfect look. There's no learning curve, no software adjustment period, no wading through features designers never use. Just your creativity and Creator2's powerful drawing, layout, image-handling, trapping, and typography controls.

# therefore I create.

With the ability to include multiple page sizes in a document, view and edit separated graphics within the application, and use both text and image style sheets, Creator2 is ideal for ads, brochures, annual reports, packaging, letterhead, and other graphic arts collaterals. And, Creator2 is customizable so you can add capabilities specific to your workflow.

Creator2 lets you do what you do best. **Design.**

To learn more about Creator2 call 1-800-245-9278  
or visit <http://creator2.multi-ad.com>



MULTI-AD  
**CREATOR<sup>2</sup>**  
The Next Generation Design Tool



Multi-Ad Services, Inc. • 1120 W. Driveway • San Jose, CA 95128 • Phone (309) 692-1530 • <http://www.multi-ad.com> ©1997 Multi-Ad Services

Circle 187 on reader service card





## Leadership by example.

You don't lay claim to leadership. Rather, you set an example that others will follow.

From the beginning, Turbo Mouse has set an example unmatched by any other input device. An example that has earned Turbo Mouse more awards than any input

device in Macintosh history. An example that has led Macworld to recently proclaim that Kensington's Turbo Mouse should be "at the top of everybody's short list of trackballs to consider."

For more information, call 800-535-4242.

# KENSINGTON®

[www.kensington.com](http://www.kensington.com)

